

# Eureka Math™

## Grade 3, Module 7

### Teacher Edition

**Published by Great Minds®.**

Copyright © 2015 Great Minds. No part of this work may be reproduced, sold, or commercialized, in whole or in part, without written permission from Great Minds. Non-commercial use is licensed pursuant to a Creative Commons Attribution-NonCommercial-ShareAlike 4.0 license; for more information, go to <http://greatminds.net/maps/math/copyright>.

Printed in the U.S.A.

This book may be purchased from the publisher at [eureka-math.org](http://eureka-math.org)

10 9 8 7 6 5 4 3 2 1



## Table of Contents

**GRADE 3 • MODULE 7**

## Geometry and Measurement Word Problems

<b>Module Overview</b> .....	2
Topic A: Solving Word Problems .....	12
Topic B: Attributes of Two-Dimensional Figures .....	52
Topic C: Problem Solving with Perimeter .....	136
<b>Mid-Module Assessment and Rubric</b> .....	230
Topic D: Recording Perimeter and Area Data on Line Plots .....	244
Topic E: Problem Solving with Perimeter and Area .....	308
<b>End-of-Module Assessment and Rubric</b> .....	403
Topic F: Year in Review .....	417
<b>Answer Key</b> .....	462

**NOTE:** Student sheets should be printed at 100% scale to preserve the intended size of figures for accurate measurements. Adjust copier or printer settings to *actual size*, and set page scaling to *none*.

## Grade 3 • Module 7

# Geometry and Measurement Word Problems

## OVERVIEW

The final module of the year offers students intensive practice with word problems, as well as hands-on investigation experiences with geometry and perimeter.

Topic A begins with solving one- and two-step word problems based on a variety of topics studied throughout the year and including all four operations (**3.OA.8**). The lessons emphasize modeling and reasoning to develop solution paths. They incorporate teacher-facilitated problem solving, opportunities for students to independently make sense of problems and persevere in solving them, and time for students to share solutions and critique peer strategies.

Topic B introduces an exploration of geometry. Students build on Grade 2 ideas about polygons and their properties, specifically developing and expanding their knowledge of quadrilaterals. They explore the attributes of quadrilaterals and classify examples into various categories, including recognizing the characteristics of polygons (**3.G.1**). Students draw polygons based on their attributes, producing sketches from descriptions like, “This shape has two long sides that are parallel, two short sides, and no right angles.”

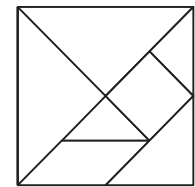

Tangram  
Puzzle

Students next use tangrams and tetrominoes (see examples to the right) to compose and decompose shapes. They reason about the relationships between shapes and between attributes. For example, students understand that quadrilaterals can be decomposed into triangles and recognize that the two smallest triangles in a tangram puzzle can be put together to form a parallelogram, a square, or a medium triangle.



Tetrominoes

Students tessellate to bridge geometry experience with the study of perimeter in Topic C. They first decompose a quadrilateral and then rearrange the parts. They use the new shape to tile. Students then define perimeter in two distinct ways: (1) as the boundary of a planar region and (2) as the length of the boundary curve. Students see varied examples from the tiles used to tessellate.



*Cut on the line. Then, slide the piece to the opposite side or rotate it to an adjacent side to make a new shape. Then, tile with the new shape.*

As they learn about perimeter as an attribute of plane figures, students apply their knowledge to real-world situations through problem solving (**3.MD.8**). They measure side lengths of shapes in whole number units to determine perimeter and solve problems where side lengths are given. They use string and rulers to measure the length around circles of different sizes. This variation prompts students to think more flexibly about perimeter, understanding that it can be the boundary of any shape and that its measurements are not limited to whole numbers. The topic ends with problems in which some measurements around the perimeter of a polygon are unknown but can be determined by reasoning. Students consider the efficiency of their strategies and identify tools for solving; for example, they use multiplication as a tool when measurements are repeated.

Topic D utilizes the line plot, familiar from Module 6, to help students draw conclusions about perimeter and area measurements (**3.MD.4**). Early in the topic, students find different possible perimeters or areas for rectangles based on information given about the rectangles. For example, using knowledge of factors from experience with multiplication, students find the following:

- Different perimeters of rectangles composed of a given number of unit squares (**3.MD.8**).  
For example, given a rectangle composed of 24 unit squares, students find four possible perimeters: 50, 28, 22, and 20 length units.
- Different areas of rectangles with a given perimeter and composed of unit squares.  
For example, students use unit squares to build rectangles with a perimeter of 12 units and determine that they can do so using 5, 8, or 9 unit squares.

(Forming rectangles with unit squares results in whole number side lengths.)

Students use line plots to show the number of rectangles they were able to construct for each set of given information. The line plots are tools that students use to help them analyze and draw conclusions about their data. Students draw their rectangles on grid paper and reason about their findings. They notice, for example, that for rectangles of a given area, those with side lengths that are equal or almost equal (more square-like) have smaller perimeters than those whose side lengths are very different (a long and narrow shape).

By the end of the topic, students are able to conclude that there is no direct relationship between area and perimeter. If an area is given, there is no way of knowing a shape's corresponding perimeter without more information about the side lengths.

In Topic E, students solve problems involving area and perimeter. After an initial lesson of problem solving with perimeter, students create a robot composed of rectangles. Given specific perimeter measurements for the rectangles, they reason about the different possible side lengths. Students compare and analyze their work, discussing how different choices for side lengths can affect area while conforming to the criteria for perimeter. Students synthesize their learning in the final lessons through solving word problems involving area and perimeter using all four operations (**3.OA.8**).

Topic F concludes the school year with a set of engaging lessons that briefly review the fundamental Grade 3 concepts of fractions, multiplication, and division. This topic comes after the End-of-Module Assessment. It begins with a pair of lessons on fractions, engaging students in analyzing and creating unusual representations of one-half, such as those shown to the right. Students analyze and discuss these representations, using their knowledge of fractions to justify their constructions and critique the work of others. The final lessons in this topic are fluency based and engage students in games that provide practice to solidify their automaticity with Grade 3 skills. Using simple origami techniques, students create booklets of these games. The booklets go home and become resources for summer practice.



## Notes on Pacing for Differentiation

If pacing is a challenge, consider the following modifications and omissions.

Move Lessons 8 and 9 to art class or to another time of day. At this level, the use of tangrams is quite similar to that of Grade 2.

Omit Lesson 11. Tessellating helps students understand that perimeter is not just a property of shapes with straight sides. Lesson 16 revisits this idea.

Omit Lesson 22. This lesson culminates Topic D by having students record data collected from Lessons 20 and 21 on a line plot. Although it deepens understanding of concepts explored in earlier lessons, no new material is presented.

Consider omitting Lessons 24–27, which guide students through a multi-day art project involving perimeter and area. If omitting, simply skip this opportunity for application.

Omit Lessons 31–34, which provide a review of important Grade 3 material including fluency and fractions. Be sure, however, to notice the resources for summer practice included in Lesson 34.



### Distribution of Instructional Minutes

This diagram represents a suggested distribution of instructional minutes based on the emphasis of particular lesson components in different lessons throughout the module.

- Fluency Practice
- Concept Development
- Application Problems
- Student Debrief

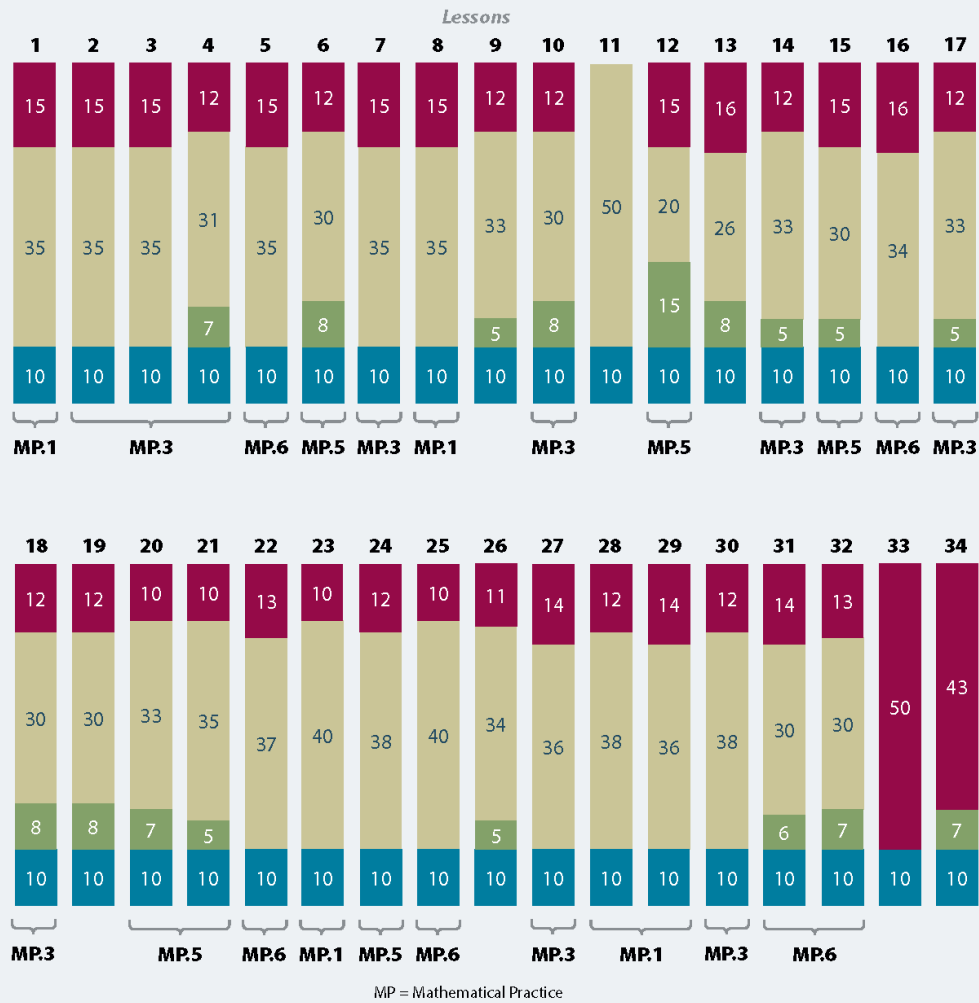

## Focus Grade Level Standards

### Solve problems involving the four operations, and identify and explain patterns in arithmetic.<sup>1</sup>

- 3.OA.8** Solve two-step word problems using the four operations. Represent these problems using equations with a letter standing for the unknown quantity. Assess the reasonableness of answers using mental computation and estimation strategies including rounding. (This standard is limited to problems posed with whole numbers and having whole number answers; students should know how to perform operations in the conventional order when there are no parentheses to specify a particular order [Order of Operations].)

### Represent and interpret data.<sup>2</sup>

- 3.MD.4** Generate measurement data by measuring lengths using rulers marked with halves and fourths of an inch. Show the data by making a line plot, where the horizontal scale is marked off in appropriate units—whole numbers, halves, or quarters.

### Geometric measurement: recognize perimeter as an attribute of plane figures and distinguish between linear and area measures.

- 3.MD.8** Solve real world and mathematical problems involving perimeters of polygons, including finding the perimeter given the side lengths, finding an unknown side length, and exhibiting rectangles with the same perimeter and different areas or with the same area and different perimeters.

### Reason with shapes and their attributes.<sup>3</sup>

- 3.G.1** Understand that shapes in different categories (e.g., rhombuses, rectangles, and others) may share attributes (e.g., having four sides), and that the shared attributes can define a larger category (e.g., quadrilaterals). Recognize rhombuses, rectangles, and squares as examples of quadrilaterals, and draw examples of quadrilaterals that do not belong to any of these subcategories.

## Foundational Standards

- 2.MD.1** Measure the length of an object by selecting and using appropriate tools such as rulers, yardsticks, meter sticks, and measuring tapes.
- 2.MD.6** Represent whole numbers as lengths from 0 on a number line diagram with equally spaced points corresponding to the numbers 0, 1, 2, ..., and represent whole-number sums and differences within 100 on a number line diagram.

---

<sup>1</sup>3.OA.9 is addressed in Module 3

<sup>2</sup>3.MD.3 is addressed in Module 6.

<sup>3</sup>3.G.2 is addressed in Module 5.

- 2.G.1** Recognize and draw shapes having specified attributes, such as a given number of angles or a given number of equal faces. Identify triangles, quadrilaterals, pentagons, hexagons, and cubes. (Sizes are compared directly or visually, not compared by measuring.)
- 3.MD.5** Recognize area as an attribute of plane figures and understand concepts of area measurement.
- A square with side length 1 unit, called “a unit square,” is said to have “one square unit” of area, and can be used to measure area.
  - A plane figure which can be covered without gaps or overlaps by  $n$  unit squares is said to have an area of  $n$  square units.
- 3.MD.6** Measure areas by counting unit squares (square cm, square m, square in, square ft, and improvised units).
- 3.MD.7** Relate area to the operations of multiplication and addition.
- Find the area of a rectangle with whole-number side lengths by tiling it, and show that the area is the same as would be found by multiplying the side lengths.
  - Multiply side lengths to find areas of rectangles with whole-number side lengths in the context of solving real world and mathematical problems, and represent whole-number products as rectangular areas in mathematical reasoning.
  - Use tiling to show in a concrete case that the area of a rectangle with whole-number side lengths  $a$  and  $b + c$  is the sum of  $a \times b$  and  $a \times c$ . Use area models to represent the distributive property in mathematical reasoning.
  - Recognize area as additive. Find areas of rectilinear figures by decomposing them into non-overlapping rectangles and adding the areas of the non-overlapping parts, applying this technique to solve real world problems.

## Focus Standards for Mathematical Practice

- MP.1** **Make sense of problems and persevere in solving them.** This module concentrates on word problems, with an emphasis on modeling and reasoning to develop solution paths for complex problems. Students have the opportunity to work independently and in small groups to develop solutions to two-step problems involving all four operations. Additionally, students make conjectures about the properties of polygons, test their thinking, and refine their ideas as they make new discoveries.
- MP.3** **Construct viable arguments and critique the reasoning of others.** The focus on problem solving in Module 7 provides opportunities for students to present their strategies, engage in peer critique, and discuss how to improve their solution pathways. Two lessons explicitly focus on these skills. In addition to engaging in this practice through word problems, students also justify why certain shapes belong in certain categories based on their shared attributes.
- MP.5** **Use appropriate tools strategically.** When solving perimeter problems, students recognize that using multiplication strategies, when appropriate, is more efficient than addition.
- MP.6** **Attend to precision.** Students learn to precisely define terms based on their observations of properties of quadrilaterals. They accurately draw shapes using descriptions of properties and straightedge tools.



## Overview of Module Topics and Lesson Objectives

Standards	Topics and Objectives	Days
3.OA.8	<p><b>A Solving Word Problems</b></p> <p>Lessons 1–2: Solve word problems in varied contexts using a letter to represent the unknown.</p> <p>Lesson 3: Share and critique peer solution strategies to varied word problems.</p>	3
3.G.1	<p><b>B Attributes of Two-Dimensional Figures</b></p> <p>Lesson 4: Compare and classify quadrilaterals.</p> <p>Lesson 5: Compare and classify other polygons.</p> <p>Lesson 6: Draw polygons with specified attributes to solve problems.</p> <p>Lesson 7: Reason about composing and decomposing polygons using tetrominoes.</p> <p>Lesson 8: Create a tangram puzzle and observe relationships among the shapes.</p> <p>Lesson 9: Reason about composing and decomposing polygons using tangrams.</p>	6
3.MD.8 3.G.1	<p><b>C Problem Solving with Perimeter</b></p> <p>Lesson 10: Decompose quadrilaterals to understand perimeter as the boundary of a shape.</p> <p>Lesson 11: Tessellate to understand perimeter as the boundary of a shape. (Optional.)</p> <p>Lesson 12: Measure side lengths in whole number units to determine the perimeter of polygons.</p> <p>Lesson 13: Explore perimeter as an attribute of plane figures and solve problems.</p> <p>Lesson 14: Determine the perimeter of regular polygons and rectangles when whole number measurements are unknown.</p> <p>Lesson 15: Solve word problems to determine perimeter with given side lengths.</p> <p>Lesson 16: Use string to measure the perimeter of various circles to the nearest quarter inch.</p> <p>Lesson 17: Use all four operations to solve problems involving perimeter and unknown measurements.</p>	8



Standards	Topics and Objectives	Days
	Mid-Module Assessment: Topics A–C (assessment 1 day, return 1 day, remediation or further applications 1 day)	3
<b>3.MD.4</b> <b>3.MD.8</b> 3.G.1	<b>D Recording Perimeter and Area Data on Line Plots</b> Lesson 18: Construct rectangles from a given number of unit squares and determine the perimeters. Lesson 19: Use a line plot to record the number of rectangles constructed from a given number of unit squares. Lessons 20–21: Construct rectangles with a given perimeter using unit squares and determine their areas. Lesson 22: Use a line plot to record the number of rectangles constructed in Lessons 20 and 21.	5
<b>3.MD.8</b> <b>3.G.1</b>	<b>E Problem Solving with Perimeter and Area</b> Lesson 23: Solve a variety of word problems with perimeter. Lessons 24–27: Use rectangles to draw a robot with specified perimeter measurements, and reason about the different areas that may be produced. Lessons 28–29: Solve a variety of word problems involving area and perimeter using all four operations. Lesson 30: Share and critique peer strategies for problem solving.	8
	End-of-Module Assessment: Topics A–E (assessment 1 day, return 1 day, remediation or further applications 1 day)	3
	<b>F Year in Review</b> Lessons 31–32: Explore and create unconventional representations of one-half. Lesson 33: Solidify fluency with Grade 3 skills. Lesson 34: Create resource booklets to support fluency with Grade 3 skills.	4
<b>Total Number of Instructional Days</b>		<b>40</b>

## Terminology

### New or Recently Introduced Terms

- Diagonal (e.g., the line drawn between opposite corners of a quadrilateral)
- Perimeter (the boundary or length of the boundary of a two-dimensional shape)
- Regular polygon (a polygon whose side lengths and interior angles are all equal)
- Tessellate (to tile a plane without gaps or overlaps)
- Tetromino (a shape composed of four squares that are connected so that every square shares at least one side with another square)

### Familiar Terms and Symbols<sup>4</sup>

- Area (the measurement of two-dimensional space in a bounded region)
- Attribute (any characteristic of a shape, including properties and other defining characteristics, e.g., straight sides and non-defining characteristics such as the color blue)
- Compose (to put two or more objects or numbers together)
- Decompose (to break an object or number into smaller parts)
- Heptagon (a flat figure enclosed by seven straight sides and seven angles)
- Hexagon (a flat figure enclosed by six straight sides and six angles)
- Octagon (a flat figure enclosed by eight straight sides and eight angles)
- Parallel (lines that do not intersect, even when extended in both directions)\*
- Parallelogram (a quadrilateral with both pairs of opposite sides parallel)
- Pentagon (a flat figure enclosed by five straight sides and five angles)
- Polygon (a closed figure with three or more straight sides, e.g., triangle, quadrilateral, pentagon, hexagon)\*
- Quadrilateral (a four-sided polygon, e.g., square, rhombus, rectangle, parallelogram, trapezoid)\*
- Rectangle (a flat figure enclosed by four straight sides, having four right angles)
- Rhombus (a flat figure enclosed by four straight sides of the same length)\*
- Right angle (e.g., a square corner)\*
- Square (a rectangle with four sides of the same length)
- Tangram (a special set of puzzle pieces with five triangles and two quadrilaterals that compose a square)
- Trapezoid (a quadrilateral with at least one pair of parallel sides)\*
- Triangle (a flat figure enclosed by three straight sides and three angles)

---

<sup>4</sup>These are terms and symbols students have seen previously. Each of the asterisked terms in this section was introduced in Grade 2 Module 8. However, given the importance of their specific definitions to this module and the amount of time elapsed between Grade 2 Module 8 and Grade 3 Module 7, they are bolded at first use in the lessons.

## Suggested Tools and Representations

- Cardstock (for making student copies of templates)
- Circular objects (a variety of sizes for students to measure)
- Grid paper
- Index cards (to use as right angle tools)
- Pattern blocks
- Rulers (measuring to the nearest quarter inch, constructed by students in Module 6)
- String
- Square tiles
- Tangrams (see the example illustrated in the Module Overview narrative)
- Tetrominoes (see the example illustrated in the Module Overview narrative)

## Scaffolds<sup>5</sup>

The scaffolds integrated into *A Story of Units* give alternatives for how students access information as well as express and demonstrate their learning. Strategically placed margin notes are provided within each lesson elaborating on the use of specific scaffolds at applicable times. They address many needs presented by English language learners, students with disabilities, students performing above grade level, and students performing below grade level. Many of the suggestions are organized by Universal Design for Learning (UDL) principles and are applicable to more than one population. To read more about the approach to differentiated instruction in *A Story of Units*, please refer to “How to Implement *A Story of Units*.”

## Assessment Summary

Type	Administered	Format	Standards Addressed
Mid-Module Assessment Task	After Topic C	Constructed response with rubric	3.OA.8 3.MD.8 3.G.1
End-of-Module Assessment Task	After Topic E	Constructed response with rubric	3.OA.8 3.MD.4 3.MD.8 3.G.1

<sup>5</sup>Students with disabilities may require Braille, large print, audio, or special digital files. Please visit the website [www.p12.nysed.gov/specialed/aim](http://www.p12.nysed.gov/specialed/aim) for specific information on how to obtain student materials that satisfy the National Instructional Materials Accessibility Standard (NIMAS) format.



## Topic A

## Solving Word Problems

## 3.OA.8

<b>Focus Standard:</b>	3.OA.8	Solve two-step word problems using the four operations. Represent these problems using equations with a letter standing for the unknown quantity. Assess the reasonableness of answers using mental computation and estimation strategies including rounding. (This standard is limited to problems posed with whole numbers and having whole number answers; students should know how to perform operations in the conventional order when there are no parentheses to specify a particular order [Order of Operations].)
<b>Instructional Days:</b>	3	
<b>Coherence -Links from:</b>	G3–M1	Properties of Multiplication and Division and Solving Problems with Units of 2–5 and 10
	G3–M3	Multiplication and Division with Units of 0, 1, 6–9, and Multiples of 10
<b>-Links to:</b>	G4–M1	Place Value, Rounding, and Algorithms for Addition and Subtraction
	G4–M3	Multi-Digit Multiplication and Division

In Topic A, students use all four operations to solve one- and two-step word problems within various contexts that were studied throughout the year. The problems are challenging and require students to carefully consider solution paths as they “make sense of problems and persevere in solving them” (MP.1).

Guided practice with strategies for problem solving is built into Lessons 1 and 2. These lessons emphasize the use of modeling through the Read-Draw-Write (RDW) process and revisit models such as tape diagrams and number bonds. Students flexibly use a letter to represent the unknown as they solve. This practice readies them for problem solving with perimeter and area in Topics C and E.

In Lesson 3, students’ level of independence within the lesson increases. They work together or on their own to develop solution paths and then share strategies and solutions. Students think critically about their own work and that of others through peer review and critique. They discuss the clarity, practicality, and efficiency of different models and strategies, refining their own understandings and approaches. Student presentations of work and protocols for critiquing are structures that provide a platform for this dialogue.

**A Teaching Sequence Toward Mastery of Solving Word Problems**

**Objective 1:** Solve word problems in varied contexts using a letter to represent the unknown.  
(Lessons 1–2)

**Objective 2:** Share and critique peer solution strategies to varied word problems.  
(Lesson 3)

## Lesson 1

**Objective:** Solve word problems in varied contexts using a letter to represent the unknown.

### Suggested Lesson Structure

■ Fluency Practice	(15 minutes)
■ Concept Development	(35 minutes)
■ Student Debrief	(10 minutes)
<b>Total Time</b>	<b>(60 minutes)</b>

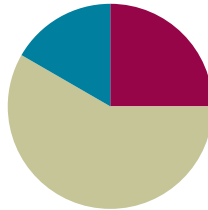

### Fluency Practice (15 minutes)

- Name the Shape **2.G.1** (3 minutes)
- Multiply by 3 **3.OA.7** (8 minutes)
- Equivalent Counting with Units of 2 **3.OA.7** (4 minutes)

### Name the Shape (3 minutes)

Note: This fluency activity reviews Grade 2 geometry concepts in preparation for Topic B.

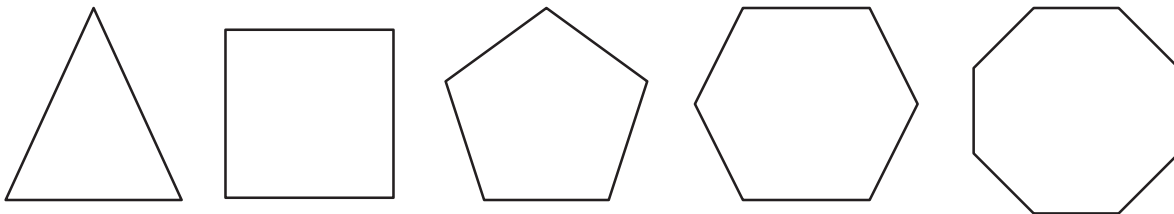

T: (Project the triangle.) What's the name of the shape?

S: Triangle.

T: (Project the square.) What's one name for this shape?

S: Square (or rectangle).

T: How many sides does a square have?

S: Four.

T: What's the name for all four-sided figures?

S: Quadrilateral.

Continue with the following possible shapes: pentagon, hexagon, and octagon.

## Multiply by 3 (8 minutes)

Materials: (S) Multiply by 3 (1–5) (Pattern Sheet)

Note: This activity builds fluency with multiplication facts using units of 3. It works toward students knowing from memory all products of two one-digit numbers.

T: (Write  $5 \times 3 = \underline{\quad}$ .) Let's skip-count up by threes to find the answer. (Raise a finger for each number to track the count. Record the skip-count answers on the board.)

S: 3, 6, 9, 12, 15.

T: (Circle 15, and write  $5 \times 3 = 15$  above it. Write  $3 \times 3 = \underline{\quad}$ .) Let's skip-count up by threes again. (Track with fingers as students count.)

S: 3, 6, 9.

T: Let's see how we can skip-count down to find the answer, too. Start at 15 with 5 fingers, 1 for each three. (Count down with fingers as students say the numbers.)

S: 15 (5 fingers), 12 (4 fingers), 9 (3 fingers).

Repeat the process for  $4 \times 3$ .

T: (Distribute the Multiply by 3 Pattern Sheet.) Let's practice multiplying by 3. Be sure to work left to right across the page.

### Directions for Administration of Multiply-By Pattern Sheet

- Distribute the Multiply-By Pattern Sheet.
- Allow a maximum of two minutes for students to complete as many problems as possible.
- Direct students to work left to right across the page.
- Encourage skip-counting strategies to solve unknown facts.

## Equivalent Counting with Units of 2 (4 minutes)

Note: This activity builds fluency with multiplication facts using units of 2. The progression builds in complexity. Work students up to the highest level of complexity where they can confidently participate.

T: Count to 10. (Write as students count. See the chart below.)

S: 1, 2, 3, 4, 5, 6, 7, 8, 9, 10.

T: (Write 1 two beneath the 1.) Count to 10 twos. (Write as students count.)

S: 1 two, 2 twos, 3 twos, 4 twos, 5 twos, 6 twos, 7 twos, 8 twos, 9 twos, 10 twos.

1	2	3	4	5	6	7	8	9	10
1 two	2 twos	3 twos	4 twos	5 twos	6 twos	7 twos	8 twos	9 twos	10 twos
2	4	6	8	10	12	14	16	18	20
1 two	4	3 twos	8	5 twos	12	7 twos	16	9 twos	20
2	2 twos	6	4 twos	10	6 twos	14	8 twos	18	10 twos



- T: Count by twos to 20. (Write as students count.)
- S: 2, 4, 6, 8, 10, 12, 14, 16, 18, 20.
- T: (Write 1 two beneath the 2. Write 4 beneath the 4.) I'm going to give you a challenge. Let's alternate between saying the units of two and the number. (Write as students count.)
- S: 1 two, 4, 3 twos, 8, 5 twos, 12, 7 twos, 16, 9 twos, 20.
- T: (Write 2 beneath 1 two and 2 twos beneath the 4.) Let's alternate again. (Write as students count.)
- S: 2, 2 twos, 6, 4 twos, 10, 6 twos, 14, 8 twos, 18, 10 twos.

### Concept Development (35 minutes)

Materials: (S) Problem Set, personal white board

Have students put the Problem Set into their personal white boards.

- T: Let's solve the first problem using our Read-Draw-Write process. What should we do first?
- S: Read the problem!
- T: Let's read together: *The sign below shows information about hayrides at the orchard.* (The sign is shown on the right.) *Lena's family buys 2 adult tickets and 2 child tickets for the hayride. How much does it cost Lena's family to go on the hayride?* Take 15 seconds to visualize the action, and then tell your partner the scene it describes.
- S: My family goes apple picking at the orchard in the fall! → I know that hayride. It's a tractor! → I can imagine a girl, her parents, and her sister or brother buying tickets.
- T: Reread the question to yourself. Then, use your own words to tell your partner what it's asking.
- S: It wants to know how much money Lena's family spends on hayride tickets.
- T: Notice the information provided to help you answer the question. What do you see?
- S: The problem says that there are four people in Lena's family. Two adults and two kids. → There's a chart, too. It tells the different prices of tickets and also when the hayrides leave.
- T: Think about the Read-Draw-Write process. What question should we ask ourselves next?
- S: What can I draw?



#### NOTES ON MULTIPLE MEANS OF ENGAGEMENT:

If English language learners and others are unfamiliar with the context of Problem 1 on the Problem Set, change *hayrides* and *orchard* to terms from a more familiar context, such as *rides* and *carnival*.

Chart to Accompany Problem 1

Hayrides	
Adult ticket . . . . .	\$7
Child ticket . . . . .	\$4
Leaves every 15 minutes starting at 11:00.	



#### NOTE ON MULTIPLE MEANS OF REPRESENTATION:

The purpose of using personal white boards is for ease of sharing work. If necessary, slip out the Problem Set, and show the work on the clear plastic sleeve using an overhead projector. Depending on the technology available, students may solve directly on the Problem Set rather than on personal white boards.

- T: Reread the problem, and think about your answer to that question. (Allow students time to do so.) Show your thinking on your personal white board. As you label your drawing, use a letter to represent the unknown.

Some possible student models are shown below.

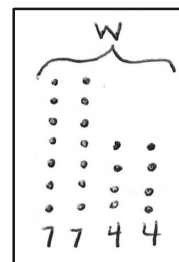
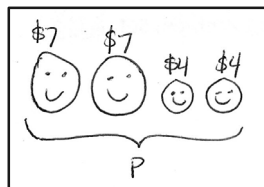
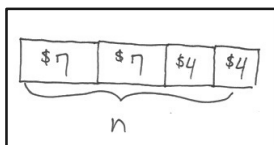
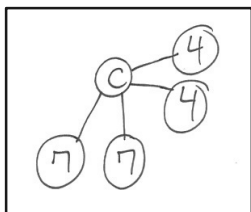

- T: Tell your partner how your drawing represents the problem. Be sure to discuss your labels, too.  
S: (Discuss drawings and labels with partners.)

Circulate and identify two or three students with different models to share their explanations with the class. Encourage the class to question the presenter if the explanation is incomplete or clarification is needed. Ask students to discuss the usefulness of the various models presented by their classmates.

- T: What information is known, and what information is unknown in this problem?  
S: We know the cost of adult and child tickets and how many of each the family bought. → We don't know how much the tickets cost altogether. → We know parts but not the whole.

**MP.1**

- T: Look back at your drawing. Think about what equations you can write based on your drawing to model the problem and solve. Share your thinking with a partner.  
S: I was just going to write  $7 + 7 + 4 + 4 = c$  and find the answer. → I was thinking  $2 \times 7 = 14$  and  $2 \times 4 = 8$ , so  $14 + 8 = n$ . → That works, but if you're going to multiply, you can just write  $(2 \times 7) + (2 \times 4) = p$ . → Or you can write  $2 \times (7 + 4) = n$ .

- T: Choose a strategy and solve.  
S: (Solve.)

Circulate and identify two or three students with different solutions to share their work with the class. During the discussion, focus on the relationship between the drawing and the equation. Students should notice that most, if not all, combinations of models and equations work together.

- T: What is the final step of our Read-Draw-Write process?  
S: Write! → Write a sentence with words to answer the problem.  
T: Do that now. Reread the question to be sure your sentence accurately answers it.  
S: (Possible answer: It costs Lena's family \$22 to go on the hayride.)  
T: Look back at your work, and try to remember your thinking at each step of the way. (Give students a few moments to recall their thoughts.) Explain your steps to your partner.  
S: I first read the problem and visualized. Then, I noticed the chart with prices. I drew a number bond to show 2 adult tickets and 2 child tickets, and I labeled the whole as the unknown. I thought about what I knew and what I didn't know. Then, I wrote this equation to find the total of the adult tickets and then the total of the child tickets. I found the whole total. Last, I reread the question and wrote a word sentence to answer it.

**MP.1** T: Suppose you tried this problem again. Would you try a different drawing? A different equation? Why or why not? Discuss with your partner. (Allow students time to discuss.)

Depending on lesson pacing and the needs of the class, guide students through another problem. Consider other methods of guidance, including the following:

- Have students read and draw the situation independently. Share and discuss more after they have completed their drawings.
- Discuss the visualization of the story, and then release students to draw and label a model and write a matching equation. Share and discuss after they have finished their drawings and equations.

If another problem is selected, facilitate discussion that encourages students to think about more than one approach to a problem. Dialogue should broaden their perspectives and begin to engage them in critically considering their choices.

### Problem Set (25 minutes)

Students should do their personal best to complete the Problem Set within the allotted 25 minutes. Some problems do not specify a method for solving. This is an intentional reduction of scaffolding that invokes MP.5, Use Appropriate Tools Strategically. Students should solve these problems using the RDW approach used for Application Problems.

For some classes, it may be appropriate to modify the assignment by specifying which problems students should work on first. With this option, let the purposeful sequencing of the Problem Set guide the selections so that problems continue to be scaffolded. Balance word problems with other problem types to ensure a range of practice. Consider assigning incomplete problems for homework or at another time during the day.

### Student Debrief (10 minutes)

Name Gina Date \_\_\_\_\_

Lena's family visits Little Tree Apple Orchard. Use the RDW process to solve the problems about Lena's visit to the orchard. Use a letter to represent the unknown in each problem.

1. The sign below shows information about hayrides at the orchard.

Hayrides

Adult ticket . . . . . \$7

Child ticket . . . . . \$4

Leaves every 15 minutes starting at 11:00.

a. Lena's family buys 2 adult tickets and 2 child tickets for the hayride. How much does it cost Lena's family to go on the hayride?

$C = 7 + 7 + 4 + 4$   
 $= 14 + 8$   
 $= 22$

It costs Lena's family \$22 to go on the hayride.

b. Lena's mom pays for the tickets with \$5 bills. She receives \$3 in change. How many \$5 bills does Lena's mom use to pay for the hayride?

$\$22 + \$3 = \$25$

$\$5 \cdot b = \$25$   
 $b = 25 \div 5$   
 $= 5$

Lena's mom used 5 five dollar bills to pay for the hayride.

c. Lena's family wants to go on the fourth hayride of the day. It's 11:38 now. How many minutes do they have to wait for the fourth hayride?

$m = 45 - 38$   
 $= 7$

They have to wait 7 minutes.

**Lesson Objective:** Solve word problems in varied contexts using a letter to represent the unknown.

The Student Debrief is intended to invite reflection and active processing of the total lesson experience.

Invite students to review their solutions for the Problem Set. They should check work by comparing answers with a partner before going over answers as a class. Look for misconceptions or misunderstandings that can be addressed in the Debrief. Guide students in a conversation to debrief the Problem Set and process the lesson.

Any combination of the questions below may be used to lead the discussion, depending on how students have been asked to solve the Problem Set.

- Invite students who used different drawings for the same problem to share their work. Facilitate a comparative discussion.
- Did you try one of the drawing or equation ideas from our lesson today in another problem on the Problem Set? Which did you use? Why did you use it for that problem?
- What operations were needed to solve Problem 2? What helped you figure that out?
- In Problems 2 and 3, division was used after either addition or subtraction. What equations did you write to show that? How can both operations be shown with a single equation?
- Why do you think we spent so much time in our lesson today talking about different ways to draw and write equations for the same problem?

2. Lena picked 17 apples and her brother picked 19. Lena's mom has a pie recipe that requires 9 apples. How many pies can Mom make with the apples that Lena and her brother picked?

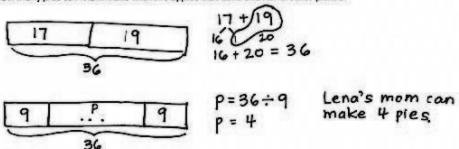

3. Lena's dad gives the cashier \$30 to pay for 5 liters of apple cider. The cashier gives him \$6 in change. How much does each liter of apple cider cost?

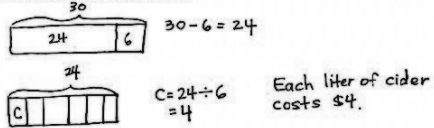

4. The apple orchard has 152 apple trees. There are 88 trees with red apples. The rest of the trees have green apples. How many more trees have red apples than green apples?

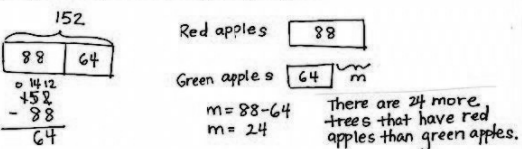

### Exit Ticket (3 minutes)

After the Student Debrief, instruct students to complete the Exit Ticket. A review of their work will help with assessing students' understanding of the concepts that were presented in today's lesson and planning more effectively for future lessons. The questions may be read aloud to the students.

Multiply.

$3 \times 1 = \underline{\quad}$      $3 \times 2 = \underline{\quad}$      $3 \times 3 = \underline{\quad}$      $3 \times 4 = \underline{\quad}$

$3 \times 5 = \underline{\quad}$      $3 \times 1 = \underline{\quad}$      $3 \times 2 = \underline{\quad}$      $3 \times 1 = \underline{\quad}$

$3 \times 3 = \underline{\quad}$      $3 \times 1 = \underline{\quad}$      $3 \times 4 = \underline{\quad}$      $3 \times 1 = \underline{\quad}$

$3 \times 5 = \underline{\quad}$      $3 \times 1 = \underline{\quad}$      $3 \times 2 = \underline{\quad}$      $3 \times 3 = \underline{\quad}$

$3 \times 2 = \underline{\quad}$      $3 \times 4 = \underline{\quad}$      $3 \times 2 = \underline{\quad}$      $3 \times 5 = \underline{\quad}$

$3 \times 2 = \underline{\quad}$      $3 \times 1 = \underline{\quad}$      $3 \times 2 = \underline{\quad}$      $3 \times 3 = \underline{\quad}$

$3 \times 1 = \underline{\quad}$      $3 \times 3 = \underline{\quad}$      $3 \times 2 = \underline{\quad}$      $3 \times 3 = \underline{\quad}$

$3 \times 4 = \underline{\quad}$      $3 \times 3 = \underline{\quad}$      $3 \times 5 = \underline{\quad}$      $3 \times 3 = \underline{\quad}$

$3 \times 4 = \underline{\quad}$      $3 \times 1 = \underline{\quad}$      $3 \times 4 = \underline{\quad}$      $3 \times 2 = \underline{\quad}$

$3 \times 4 = \underline{\quad}$      $3 \times 3 = \underline{\quad}$      $3 \times 4 = \underline{\quad}$      $3 \times 5 = \underline{\quad}$

$3 \times 4 = \underline{\quad}$      $3 \times 5 = \underline{\quad}$      $3 \times 1 = \underline{\quad}$      $3 \times 5 = \underline{\quad}$

$3 \times 2 = \underline{\quad}$      $3 \times 5 = \underline{\quad}$      $3 \times 3 = \underline{\quad}$      $3 \times 5 = \underline{\quad}$

$3 \times 4 = \underline{\quad}$      $3 \times 2 = \underline{\quad}$      $3 \times 4 = \underline{\quad}$      $3 \times 3 = \underline{\quad}$

$3 \times 5 = \underline{\quad}$      $3 \times 3 = \underline{\quad}$      $3 \times 2 = \underline{\quad}$      $3 \times 4 = \underline{\quad}$

$3 \times 3 = \underline{\quad}$      $3 \times 5 = \underline{\quad}$      $3 \times 2 = \underline{\quad}$      $3 \times 4 = \underline{\quad}$

multiply by 3 (1–5)

Name \_\_\_\_\_

Date \_\_\_\_\_

Lena's family visits Little Tree Apple Orchard. Use the RDW process to solve the problems about Lena's visit to the orchard. Use a letter to represent the unknown in each problem.

1. The sign below shows information about hayrides at the orchard.



- a. Lena's family buys 2 adult tickets and 2 child tickets for the hayride. How much does it cost Lena's family to go on the hayride?
- b. Lena's mom pays for the tickets with \$5 bills. She receives \$3 in change. How many \$5 bills does Lena's mom use to pay for the hayride?
- c. Lena's family wants to go on the fourth hayride of the day. It's 11:38 now. How many minutes do they have to wait for the fourth hayride?



Name \_\_\_\_\_

Date \_\_\_\_\_

Use the RDW process to solve the problem below. Use a letter to represent the unknown.

Sandra keeps her sticker collection in 7 albums. Each album has 40 stickers in it. She starts a new album that has 9 stickers in it. How many total stickers does she have in her collection?



Name \_\_\_\_\_

Date \_\_\_\_\_

Max's family takes the train to visit the city zoo. Use the RDW process to solve the problems about Max's trip to the zoo. Use a letter to represent the unknown in each problem.

1. The sign below shows information about the train schedule into the city.

Train Fare—One Way	
Adult.....	\$8
Child.....	\$6
Leaves every 15 minutes starting at 6:00 a.m.	

- a. Max's family buys 2 adult tickets and 3 child tickets. How much does it cost Max's family to take the train into the city?
- b. Max's father pays for the tickets with \$10 bills. He receives \$6 in change. How many \$10 bills does Max's father use to pay for the train tickets?
- c. Max's family wants to take the fourth train of the day. It's 6:38 a.m. now. How many minutes do they have to wait for the fourth train?

2. At the city zoo, they see 17 young bats and 19 adult bats. The bats are placed equally into 4 areas. How many bats are in each area?
  
  
  
  
  
  
  
  
  
  
3. Max's father gives the cashier \$20 to pay for 6 water bottles. The cashier gives him \$8 in change. How much does each water bottle cost?
  
  
  
  
  
  
  
  
  
  
4. The zoo has 112 types of reptiles and amphibians in their exhibits. There are 72 types of reptiles, and the rest are amphibians. How many more types of reptiles are there than amphibians in the exhibits?

## Lesson 2

**Objective:** Solve word problems in varied contexts using a letter to represent the unknown.

### Suggested Lesson Structure

■ Fluency Practice	(15 minutes)
■ Concept Development	(35 minutes)
■ Student Debrief	(10 minutes)
<b>Total Time</b>	<b>(60 minutes)</b>

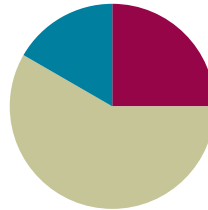

#### A NOTE ON STANDARDS ALIGNMENT:

Problems 2 and 5 on the Problem Set, the Exit Ticket, and Problems 1 and 5 on the Homework are two-step word problems involving milliliters and grams. The masses and volumes are given in the same units in each problem. Standard **3.MD.2** specifically states that students “solve one-step problems involving masses or volumes that are given in the same units.” However, these problems look ahead to **4.MD.2**. Students working above grade level might enjoy the challenge of solving these two-step word problems involving milliliters and grams. To make these problems accessible to students working below grade level, modify the problems so they can be solved with one step.

### Fluency Practice (15 minutes)

- Name the Shape **2.G.1** (3 minutes)
- Multiply by 3 **3.OA.7** (8 minutes)
- Equivalent Counting with Units of 4 **3.OA.7** (4 minutes)

### Name the Shape (3 minutes)

Note: This activity reviews Grade 2 geometry concepts in preparation for Topic B.

T: (Project the triangle.) What’s the name of the shape?

S: Triangle.

T: (Project the rectangle.) What’s one name for this shape?

S: Rectangle (or parallelogram or quadrilateral).

T: How many sides does a rectangle have?

S: Four.

T: How many right angles does a rectangle have?

S: Four!

T: What’s the name for all four-sided figures?

S: Quadrilateral.

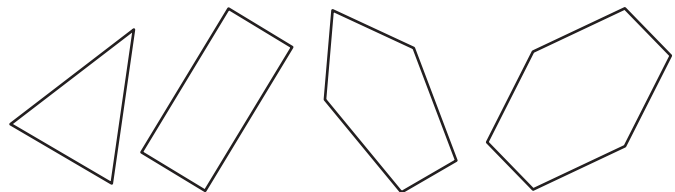

Continue with the following possible shapes: pentagon and hexagon.

### Multiply by 3 (8 minutes)

Materials: (S) Multiply by 3 (6–10) Pattern Sheet

Note: This activity builds fluency with multiplication facts using units of 3. It works toward students knowing from memory all products of two one-digit numbers. See Lesson 1 for the directions for administration of a Multiply-By Pattern Sheet.

T: (Write  $7 \times 3 = \underline{\quad}$ .) Let's skip-count up by threes. I'll raise a finger for each three. (Raise a finger for each number to track the count.)

S: 3, 6, 9, 12, 15, 18, 21.

T: Let's skip-count by threes starting at 15. Why is 15 a good place to start?

S: It's a fact we already know, so we can use it to figure out a fact we don't know.

T: (Track with fingers as students say the numbers.)

S: 15 (5 fingers), 18 (6 fingers), 21 (7 fingers).

T: Let's see how we can skip-count down to find the answer, too. Start at 30 with 10 fingers, 1 for each three. (Count down with fingers as students say the numbers.)

S: 30 (10 fingers), 27 (9 fingers), 24 (8 fingers), 21 (7 fingers).

Continue with the following possible sequence:  $9 \times 3$ ,  $6 \times 3$ , and  $8 \times 3$ .

T: (Distribute the Multiply by 3 Pattern Sheet.) Let's practice multiplying by 3. Be sure to work left to right across the page.

### Equivalent Counting with Units of 4 (4 minutes)

Note: This activity builds fluency with multiplication facts using units of 4. The progression builds in complexity. Work students up to the highest level of complexity where they can confidently participate.

T: Count to 10. (Write as students count. See the chart below.)

S: 1, 2, 3, 4, 5, 6, 7, 8, 9, 10.

T: (Write 1 four beneath the 1.) Count to 10 fours. (Write as students count.)

1	2	3	4	5	6	7	8	9	10
1 four	2 fours	3 fours	4 fours	5 fours	6 fours	7 fours	8 fours	9 fours	10 fours
4	8	12	16	20	24	28	32	36	40
1 four	8	3 fours	16	5 fours	24	7 fours	32	9 fours	40
4	2 fours	12	4 fours	20	6 fours	28	8 fours	36	10 fours

S: 1 four, 2 fours, 3 fours, 4 fours, 5 fours, 6 fours, 7 fours, 8 fours, 9 fours, 10 fours.

T: Count by fours to 40. (Write as students count.)

S: 4, 8, 12, 16, 20, 24, 28, 32, 36, 40.

- T: (Write 1 four beneath the 4. Write 8 beneath the 8.) I'm going to give you a challenge. Let's alternate between saying the units of four and the number. (Write as students count.)
- S: 1 four, 8, 3 fours, 16, 5 fours, 24, 7 fours, 32, 9 fours, 40.
- T: (Write 4 beneath 1 four and 2 fours beneath the 8.) Let's alternate again. (Write as students count.)
- S: 4, 2 fours, 12, 4 fours, 20, 6 fours, 28, 8 fours, 36, 10 fours.

### Concept Development (35 minutes)

Materials: (S) Problem Set, 1 piece of chart paper per pair or triad, 1 different color marker per student in each group

#### Part 1: Work cooperatively to identify multiple solution paths.

Note: Sample talking points and questions to guide student explanations and class participation are listed in Part 2 of this lesson. Use them as a resource in Part 1.

Create groups of two or three students. Distribute the Problem Set, chart paper, and markers to students.

- T: Today, we're going to work in groups to solve Problem 6. Let's prepare our chart paper by folding it into three equal parts. (Model for students, and allow them time to fold.) With your group, read Problem 6 now.
- S: The total amount of rain that fell in New York City in two years was 282 centimeters. In the first year, 185 centimeters of rain fell. How many more centimeters of rain fell in the first year than in the second year?
- T: Take a quiet moment to visualize the problem. (Give students about 15 seconds to visualize.) Describe the problem to your group.
- S: It's a problem about rain, and someone measured it. → Maybe with a graduated cylinder. → That would be a huge cylinder! Imagine how tall 282 centimeters is! → They probably measured the rain each day or week and then added to find the total. → We're talking about a lot of rain.
- T: Think about our Read-Draw-Write process. At the signal, say the question we should be asking ourselves. (Signal.)
- S: What can I draw?
- T: Work with your group to draw at least two different ways to represent the problem. Make the drawings on the top third of your paper. Each of you has a different color marker so that your participation shows on your poster. Make sure each member of your group contributes.
- S: (Discuss and draw. Some possible drawings are shown below.)

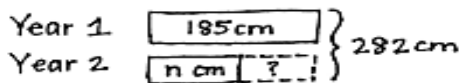
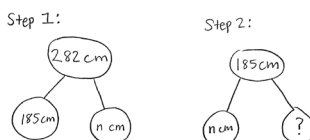
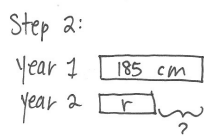
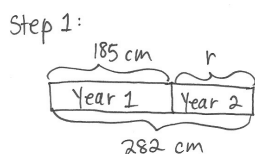

- T: As you drew, what did you notice about the problem that will help you solve?
- S: We noticed it's a two-step problem. → We know the total and the amount of rain in Year 1.  
→ We have to find out how much rain there was in Year 2. → That doesn't answer the question, though. We have to know how much *more* rain there was in Year 1. That's subtracting two times!
- T: You have more than one drawing on your paper. As a group, discuss which one represents the problem most clearly. Circle it, and be ready to talk about your choice.
- S: (Discuss and circle a model.)

Select two or three groups to share their thinking with the rest of the class. Choose groups strategically to spark discussion and push learning in terms of both modeling and oral explanation. Selections could include a group with an exemplary choice, a group with an unusual choice, or a group with an excellent explanation.

- S: (Listen to groups share, ask questions, and compare work.)
- T: Is your thinking about your work or the problem different after listening to your friends? Take a moment to check in with your group. Adjust your drawing or thinking based on what you saw and heard.
- S: (Discuss and possibly make modifications to work.)
- T: Think about the Read-Draw-Write process. What is our next step?
- S: To write equations and solve!
- T: Work with your group to write equations and solve the problem. Use your drawing. Record your work in the middle third of your chart paper, and be ready to talk about your steps.
- S: The first step is just subtraction. We can do  $282 \text{ cm} - 185 \text{ cm}$  to find the amount of rain in Year 2.  
→ It's not that easy with mental math. Let's use the algorithm. → Actually, you can think of 282 as 285. Then, I can subtract 185 easily to get 100. Since I added 3 to 282 to get 285, I have to subtract 3 from the answer, so it's 97. → Now, I think we should subtract again. We can do  $185 - 97$  to find out how much more rain there was. → Let's solve that one with the algorithm.  $185 - 97 = 88$ . So, the answer is 88 centimeters. → I don't have to use the algorithm. I can break apart 185 as 100 and 85. That's  $3 + 85$  because I took the 97 from 100. The answer is 88 cm.

Select a few groups to share their thinking with the rest of the class. Again, choose groups strategically. Allow students time to listen to the groups, share, and ask questions.

- T: Take a moment to compare your work with what you saw and heard, and maybe make adjustments.
- S: (Briefly discuss comparison within groups and possibly modify work.)
- T: Work with your group to finish the problem. What is our final step?
- S: To write a sentence that answers the question.
- T: Record your sentence on the bottom third of your paper.
- S: (Write a sentence with words to answer the question. Possible responses: 88 more centimeters of rain fell in the first year than in the second. → There were 88 more centimeters of rain in Year 1.)

Select a few groups to share their work with the rest of the class. Notice which students may not have reread the question before writing. If necessary, guide students to adjust their sentences so that their answers more closely align with the question asked.

**Part 2: Work independently to solve and present problems using multiple solution paths.**

Assign each student two problems from the Problem Set. Challenge them to record more than one way to draw for each problem they solve. Ask students to share their work with the members of their groups from Part 1. When sharing, students should include answers to the following questions:

- How does your drawing represent the problem clearly?
- How did your drawing help you decide on a way to solve?
- Why does the equation that you used to model make sense with your drawing and with the problem?
- How do you know you answered the question?

**MP.3**

Have students share their work in groups of three or four. Encourage group members to practice asking questions of the presenter. They might ask some of the questions listed below.

- I'm not sure what you mean. Can you say more about that?
- Why did you decide \_\_\_\_\_?
- What do you think about \_\_\_\_\_ instead?
- Which other way did you try to draw the problem?

One way to close this process is to have students write a compliment to another presenter. If time allows, students may solve problems on the Problem Set that they have not already completed on their own before the Student Debrief.

**Student Debrief (10 minutes)**

**Lesson Objective:** Solve word problems in varied contexts using a letter to represent the unknown.

The Student Debrief is intended to invite reflection and active processing of the total lesson experience.

Guide students in a conversation to debrief the Problem Set and process the lesson.

Any combination of the questions below may be used to lead the discussion, depending on how the students were asked to solve the Problem Set.

- How are your models related to your equations in Problem 1?

**A NOTE ON STANDARDS ALIGNMENT:**

Problems 2 and 5 on the Problem Set, the Exit Ticket, and Problems 1 and 5 on the Homework are two-step word problems involving milliliters and grams. The masses and volumes are given in the same units in each problem. Standard **3.MD.2** specifically states that students “solve one-step problems involving masses or volumes that are given in the same units.” However, these problems look ahead to **4.MD.2**. Students working above grade level might enjoy the challenge of solving these two-step word problems involving milliliters and grams. To make these problems accessible to students working below grade level, modify the problems so they can be solved with one step.

Name Gina Date \_\_\_\_\_

Use the RDW process to solve. Use a letter to represent the unknown in each problem.

1. Leanne needs 120 tiles for an art project. She has 56 tiles. If tiles are sold in boxes of 8, how many more boxes of tiles does Leanne need to buy?

$120$   
 $\begin{array}{r} 56 \\ 8 \overline{)120} \\ \underline{80} \\ 40 \\ \underline{40} \\ 0 \end{array}$

$b = 64 \div 8$   
 $b = 8$

Leanne needs to buy 8 more boxes of tiles.

2. Gwen pours 236 milliliters of water into Ravi's beaker. Henry pours 189 milliliters of water into Ravi's beaker. Ravi's beaker now contains 800 milliliters of water. How much water was in Ravi's beaker to begin with?

$236$   $189$

$236 + 189$   
 $\begin{array}{r} 236 \\ +189 \\ \hline 275 \end{array}$   
 $275 + 200 = 475$

$800$   
 $\begin{array}{r} 425 \\ + r \\ \hline 800 \end{array}$   
 $r = 800 - 425$   
 $r = 375$

Ravi's beaker had 375 mL of water to begin with.

3. Maude hung 3 pictures on her wall. Each picture measures 8 inches by 10 inches. What is the total area of the wall covered by the pictures?

$8$  in  $10$  in

$\begin{array}{r} 80 \\ 80 \\ 80 \end{array}$   
 $p = 3 \times 80$   
 $p = 3 \times 8 \text{ tens}$   
 $p = 24 \text{ tens}$   
 $p = 240$

The total area of the wall covered by the pictures is 240 square inches.

- Invite students to share different equations that can be used to solve Problem 3.
- What operations are used to solve Problem 4? In what order? How did you figure that out?
- Invite students to articulate their thought processes for preparing to present their work.
- How did it feel to present your work to friends?
- What did you learn about yourself or your work by presenting?
- What was it like to be an audience member to a friend who was presenting?
- Did you find it easy or difficult to ask your friends questions about their work? Why?

### Exit Ticket (3 minutes)

After the Student Debrief, instruct students to complete the Exit Ticket. A review of their work will help with assessing students' understanding of the concepts that were presented in today's lesson and planning more effectively for future lessons. The questions may be read aloud to the students.

4. Kami scored a total of 21 points during her basketball game. She made 6 two-point shots, and the rest were three-point shots. How many three-point shots did Kami make?

$6 \times 2 = 12$

$21 - 12 = 9$

$k = 9 \div 3$   
 $k = 3$

Kami made 3 three-point shots.

5. An orange weighs 198 grams. A kiwi weighs 85 grams less than the orange. What is the total weight of the fruit?

Orange 198  
kiwi 113 85

$198 - 85 = 113$

$W = 198 + 113$   
 $W = 200 + 113$   
 $W = 311$

The total weight of the fruit is 311 grams.

6. The total amount of rain that fell in New York City in two years was 282 centimeters. In the first year, 185 centimeters of rain fell. How many more centimeters of rain fell in the first year than in the second year?

282

Year 1 185  
Year 2 97

$r = 185 - 97$   
 $r = 88$

88 more centimeters of rain fell in the first year than in the second year.



Multiply.

$3 \times 1 = \underline{\quad}$      $3 \times 2 = \underline{\quad}$      $3 \times 3 = \underline{\quad}$      $3 \times 4 = \underline{\quad}$

$3 \times 5 = \underline{\quad}$      $3 \times 6 = \underline{\quad}$      $3 \times 7 = \underline{\quad}$      $3 \times 8 = \underline{\quad}$

$3 \times 9 = \underline{\quad}$      $3 \times 10 = \underline{\quad}$      $3 \times 5 = \underline{\quad}$      $3 \times 6 = \underline{\quad}$

$3 \times 5 = \underline{\quad}$      $3 \times 7 = \underline{\quad}$      $3 \times 5 = \underline{\quad}$      $3 \times 8 = \underline{\quad}$

$3 \times 5 = \underline{\quad}$      $3 \times 9 = \underline{\quad}$      $3 \times 5 = \underline{\quad}$      $3 \times 10 = \underline{\quad}$

$3 \times 6 = \underline{\quad}$      $3 \times 5 = \underline{\quad}$      $3 \times 6 = \underline{\quad}$      $3 \times 7 = \underline{\quad}$

$3 \times 6 = \underline{\quad}$      $3 \times 8 = \underline{\quad}$      $3 \times 6 = \underline{\quad}$      $3 \times 9 = \underline{\quad}$

$3 \times 6 = \underline{\quad}$      $3 \times 7 = \underline{\quad}$      $3 \times 6 = \underline{\quad}$      $3 \times 7 = \underline{\quad}$

$3 \times 8 = \underline{\quad}$      $3 \times 7 = \underline{\quad}$      $3 \times 9 = \underline{\quad}$      $3 \times 7 = \underline{\quad}$

$3 \times 8 = \underline{\quad}$      $3 \times 6 = \underline{\quad}$      $3 \times 8 = \underline{\quad}$      $3 \times 7 = \underline{\quad}$

$3 \times 8 = \underline{\quad}$      $3 \times 9 = \underline{\quad}$      $3 \times 9 = \underline{\quad}$      $3 \times 6 = \underline{\quad}$

$3 \times 9 = \underline{\quad}$      $3 \times 7 = \underline{\quad}$      $3 \times 9 = \underline{\quad}$      $3 \times 8 = \underline{\quad}$

$3 \times 9 = \underline{\quad}$      $3 \times 8 = \underline{\quad}$      $3 \times 6 = \underline{\quad}$      $3 \times 9 = \underline{\quad}$

$3 \times 7 = \underline{\quad}$      $3 \times 9 = \underline{\quad}$      $3 \times 6 = \underline{\quad}$      $3 \times 8 = \underline{\quad}$

$3 \times 9 = \underline{\quad}$      $3 \times 7 = \underline{\quad}$      $3 \times 6 = \underline{\quad}$      $3 \times 8 = \underline{\quad}$

multiply by 3 (6–10)



- Kami scored a total of 21 points during her basketball game. She made 6 two-point shots, and the rest were three-point shots. How many three-point shots did Kami make?
- An orange weighs 198 grams. A kiwi weighs 85 grams less than the orange. What is the total weight of the fruit?
- The total amount of rain that fell in New York City in two years was 282 centimeters. In the first year, 185 centimeters of rain fell. How many more centimeters of rain fell in the first year than in the second year?

Name \_\_\_\_\_

Date \_\_\_\_\_

Use the RDW process to solve the problem below. Use a letter to represent the unknown.

Jaden's bottle contains 750 milliliters of water. He drinks 520 milliliters at practice and then another 190 milliliters on his way home. How many milliliters of water are left in Jaden's bottle when he gets home?

Name \_\_\_\_\_

Date \_\_\_\_\_

Use the RDW process to solve. Use a letter to represent the unknown in each problem.

1. A box containing 3 small bags of flour weighs 950 grams. Each bag of flour weighs 300 grams. How much does the empty box weigh?
2. Mr. Cullen needs 91 carpet squares. He has 49 carpet squares. If the squares are sold in boxes of 6, how many more boxes of carpet squares does Mr. Cullen need to buy?
3. Erica makes a banner using 4 sheets of paper. Each paper measures 9 inches by 10 inches. What is the total area of Erica's banner?

4. Monica scored 32 points for her team at the Science Bowl. She got 5 four-point questions correct, and the rest of her points came from answering three-point questions. How many three-point questions did she get correct?
5. Kim's black kitten weighs 175 grams. Her gray kitten weighs 43 grams less than the black kitten. What is the total weight of the two kittens?
6. Cassias and Javier's combined height is 267 centimeters. Cassias is 128 centimeters tall. How much taller is Javier than Cassias?

## Lesson 3

**Objective:** Share and critique peer solution strategies to varied word problems.

### Suggested Lesson Structure

■ Fluency Practice	(15 minutes)
■ Concept Development	(35 minutes)
■ Student Debrief	(10 minutes)
<b>Total Time</b>	<b>(60 minutes)</b>

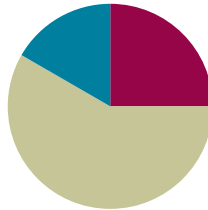

### Fluency Practice (15 minutes)

- Name the Shape **2.G.1** (3 minutes)
- Multiply by 4 **3.OA.7** (8 minutes)
- Equivalent Counting with Units of 3 **3.OA.7** (4 minutes)

### Name the Shape (3 minutes)

Note: This activity reviews Grade 2 geometry concepts in preparation for Topic B.

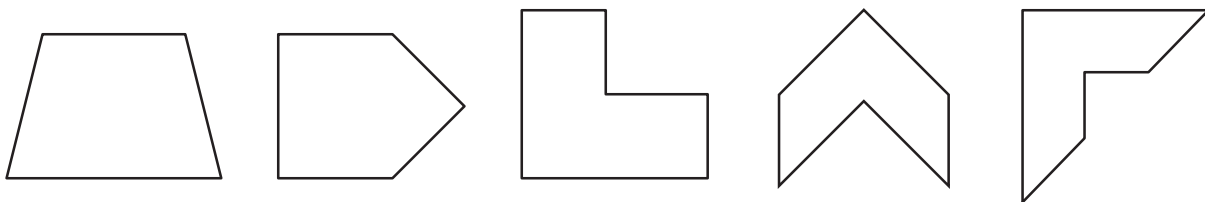

T: (Project the trapezoid.) How many sides does this shape have?

S: Four sides.

T: What's the name for all four-sided figures?

S: Quadrilateral.

T: (Project the pentagon.) How many sides does this shape have?

S: Five.

T: What's the name for all five-sided figures?

S: Pentagon.

Continue the process for all three hexagons.

### Multiply by 4 (8 minutes)

Materials: (S) Multiply by 4 (1–5) Pattern Sheet

Note: This activity builds fluency with multiplication facts using units of 4. It works toward students knowing from memory all products of two one-digit numbers. See Lesson 1 for the directions for administration of a Multiply-By Pattern Sheet.

T: (Write  $5 \times 4 = \underline{\quad}$ .) Let's skip-count up by fours to find the answer. (Raise a finger for each number to track the count. Record the skip-count answers on the board.)

S: 4, 8, 12, 16, 20.

T: (Circle 20, and write  $5 \times 4 = 20$  above it. Write  $3 \times 4 = \underline{\quad}$ .) Let's skip-count up by fours again. (Track with fingers as students count.)

S: 4, 8, 12.

T: Let's see how we can skip-count down to find the answer, too. Start at 20 with 5 fingers, 1 for each four. (Count down with fingers as students say the numbers.)

S: 20 (5 fingers), 16 (4 fingers), 12 (3 fingers).

Repeat the process for  $4 \times 4$ .

T: (Distribute the Multiply by 4 Pattern Sheet.) Let's practice multiplying by 4. Be sure to work left to right across the page.

### Equivalent Counting with Units of 3 (4 minutes)

Note: This activity builds fluency with multiplication facts using units of 3. The progression builds in complexity. Work students up to the highest level of complexity where they can confidently participate.

T: Count to 10. (Write as students count. See the chart below.)

1	2	3	4	5	6	7	8	9	10
1 three	2 threes	3 threes	4 threes	5 threes	6 threes	7 threes	8 threes	9 threes	10 threes
3	6	9	12	15	18	21	24	27	30
1 three	6	3 threes	12	5 threes	18	7 threes	24	9 threes	30
3	2 threes	9	4 threes	15	6 threes	21	8 threes	27	10 threes

S: 1, 2, 3, 4, 5, 6, 7, 8, 9, 10.

T: (Write 1 three beneath the 1.) Count to 10 threes. (Write as students count.)

S: 1 three, 2 threes, 3 threes, 4 threes, 5 threes, 6 threes, 7 threes, 8 threes, 9 threes, 10 threes.

T: Count by threes to 30. (Write as students count.)

S: 3, 6, 9, 12, 15, 18, 21, 24, 27, 30.



- T: (Write 1 three beneath the 3. Write 6 beneath the 6.) I'm going to give you a challenge. Let's alternate between saying the units of three and the number. (Write as students count.)
- S: 1 three, 6, 3 threes, 12, 5 threes, 18, 7 threes, 24, 9 threes, 30.
- T: (Write 3 beneath 1 three and 2 threes beneath the 6.) Let's alternate again. (Write as students count.)
- S: 3, 2 threes, 9, 4 threes, 15, 6 threes, 21, 8 threes, 27, 10 threes.

### Concept Development (35 minutes)

Materials: (T) Student work samples (Template) pictured below (S) Problem Set, personal white board

#### Problem 1: Assess sample student work for accuracy and efficiency.

Write or project the following problem: Mrs. Mashburn buys 6 boxes of pencils. Nine pencils come in each box. She gives each of the 24 students in her class 2 pencils. How many pencils does she have left?

- T: Use the Read-Draw-Write process to solve this problem. Remember to take a moment to visualize what's happening in the problem after you read.
- S: (Use the RDW process to solve.)
- T: Compare your work with a partner's. (Allow students time to compare.) How many pencils does Mrs. Mashburn have left?
- S: 6 pencils!
- T: (Project Student A's work from the Template.) Let's look at and discuss some possible solutions for this problem. What did Student A do to solve this problem?
- S: He used a tape diagram to find the total number of pencils. Then, he figured out how many pencils the teacher gave away and subtracted. → He broke apart  $24 \times 2$  to make it an easier problem!

Template

Total pencils

9	9	9	9	9	9
---	---	---	---	---	---

$6 \times 9 = 54$

Student A

Pencils she gave away

$$24 \times 2$$

$$(6 \times 4) \times 2$$

$$6 \times (4 \times 2)$$

$$6 \times 8 = 48$$

44	
<del>54</del>	
- 48	
6	

Mrs. Mashburn has 6 pencils left.

- T: Other than getting the right answer, what did Student A do well?
- S: Student A used all the steps in the RDW process. → He labeled the parts of the problem, *Total pencils* and *Pencils she gave away*. → He broke apart 24 into  $6 \times 4$ , which helped him solve  $24 \times 2$ . → He moved the parentheses to solve hard multiplication.

Facilitate a discussion in which students analyze this work. Choose any combination of the following questions to help guide the conversation:

- Was the drawing helpful? What makes the drawing helpful or unhelpful?
- Did Student A represent all the important information in his drawing? Why or why not?
- Was this drawing the best one to use? Why or why not?
- Can you retell the story using only the drawing and labels? Explain.
- How did he organize the information?
- Was his method of solving the most efficient way? Why or why not?
- Would you have chosen to solve the problem this way? Why or why not?

T: What suggestion would you make to Student A to improve his work?

S: Moving the parentheses is a lot of work for  $24 \times 2$ . It's faster to solve with mental math, by thinking of it as  $24 + 24$ .  $\rightarrow$  Instead of the subtraction equation, maybe just count on from 48 to 54. The difference is small. Use 2 to complete the 10; then add 4. That's 6.  $\rightarrow$  He could use a letter to represent the unknown in the problem.  $\rightarrow$  He could draw another tape diagram to show why he subtracted in the last step.

Use the following two samples below, modify them, or create new ones, and repeat the process of analyzing sample student work. Select which samples to use by considering the discussion that would most benefit the needs of students.

Student B

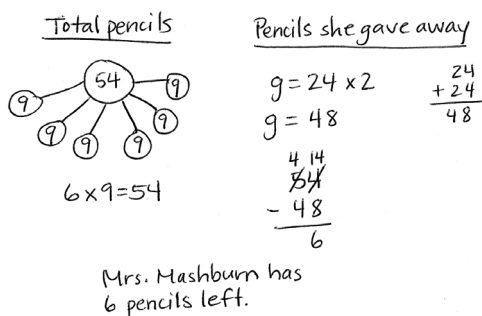

Student C

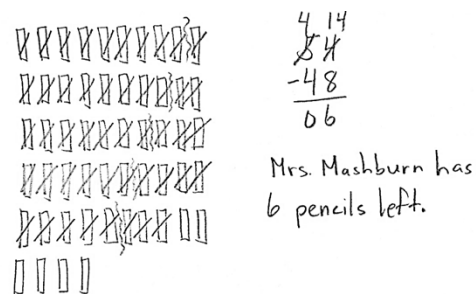

Note: While considering the discussion that would most benefit the needs of students, try modifying the samples to show the following common mistakes:

- Student B might miscalculate  $6 \times 9$  as 56.
- Student C might forget to cross out or draw a pencil.
- The sentence might not address the question directly.
- The student might misread the problem (e.g., solve for a scenario where Mrs. Mashburn gives each student 6 pencils).

T: Discuss with a partner: How are the three ways of solving similar? How are they different?

S: (Allow time for partner discussion.)

T: Which solution would you say is most efficient? Why? Talk with your partner.

S: Either Student A's or Student B's. → I think Student B's because he solved  $24 \times 2$  more easily than Student A. → I agree. They both drew clear pictures to find the total number of pencils, but Student B's way of doing the equation is easier and may be quicker for finding the number of pencils the teacher gave away.

T: Which solution would you say is least efficient? Why?

S: Student C's. Drawing the pencils and crossing them out must have taken forever. → And Student C didn't really even need the equation if she did it that way. It's easy to see from the model that there are 6 left.

T: Compare all three samples to your own work. With a partner, discuss the strengths of your own work, and also talk about what you might try differently.

S: (Discuss.)

### Problem 2: Assess peer work for accuracy and efficiency.

Distribute the Problem Set to each student.

T: Work with your partner to find two different ways to solve Problem 1 on your Problem Set. Be sure to use the RDW process when solving.

After students solve, elicit possible solutions from them. Lead a discussion in which students compare and contrast each other's work and analyze the clarity of each solution path. Students may then independently solve the rest of the problems on the Problem Set. Ask students to swap personal white boards with their partners after solving, and discuss the following:

- Study your partner's work. Try to explain how your partner solved the problem.
- Compare the strategies that you used with your partner's strategies. How are they the same? How are they different?
- What did your partner do well?
- What suggestions do you have for your partner that might improve her work?
- Why would your suggestions be an improvement?
- What are the strengths of your own work? Why do some methods work better for you than others?

MP.3



#### NOTES ON MULTIPLE MEANS OF ACTION AND EXPRESSION:

Remind and guide students to identify strategies, including but not limited to the following:

- Use the associative property to make an easier problem, for example,  
 $12 \times 3 = (6 \times 2) \times 3 = 6 \times (2 \times 3)$ .
- Combine easy number pairs.
- Use methods for multiplying by 7, 8, 9, for example,  
 $6 \times 9 = (5 \times 9) + 9 = 54$ , or the finger strategy.
- Model with a labeled tape diagram.

**Student Debrief (10 minutes)**

**Lesson Objective:** Share and critique peer solution strategies to varied word problems.

The Student Debrief is intended to invite reflection and active processing of the total lesson experience.

Invite students to review their solutions for the Problem Set. They should check work by comparing answers with a partner before going over answers as a class. Look for misconceptions or misunderstandings that can be addressed in the Debrief. Guide students in a conversation to debrief the Problem Set and process the lesson.

Any combination of the questions below may be used to lead the discussion.

- What can you draw to show Problem 2? How can you build equations from those drawings?
- Invite students to share and compare their processes for solving Problem 4.
- What was your first step toward solving Problem 5? How did you figure that out? Once you finished the first step, how did you choose a strategy for solving the second step?
- How might it be helpful to your own work to analyze another person's work?
- What was it like to have a friend critique your work?

**Exit Ticket (3 minutes)**

After the Student Debrief, instruct students to complete the Exit Ticket. A review of their work will help with assessing students' understanding of the concepts that were presented in today's lesson and planning more effectively for future lessons. The questions may be read aloud to the students.

Name: Gina Date: \_\_\_\_\_

Use the RDW process to solve the problems below. Use a letter to represent the unknown in each problem. When you are finished, share your solutions with a partner. Discuss and compare your strategies with your partner's strategies.

1. Monica measures 91 milliliters of water into 9 tiny beakers. She measures an equal amount of water into the first 8 beakers. She pours the remaining water into the ninth beaker. It measures 19 milliliters. How many milliliters of water are in each of the first 8 beakers?

$91 \text{ mL}$   
 $91 - 19 = 72$   
 $72 \div 8 = e$   
 $9 = e$   
 There are 9 mL of water in each of the first 8 beakers.

2. Matthew and his dad put up 8 six-foot lengths of fence on Monday and 9 six-foot lengths on Tuesday. What is the total length of the fence?

Monday:  $8 \times 6 = 48$   
 Tuesday:  $9 \times 6 = 54$   
 $f = 48 + 54$   
 $f = 102$   
 The total length of the fence is 102 feet.

3. The total weight of Laura's new pencils is 112 grams. One pencil rolls off the scale. Now, the scale reads 105 grams. What is the total weight of 7 new pencils?

$112$   
 $112$   
 $- 105$   
 $\hline 7$   
 $W = 7 \times 7$   
 $W = 49$   
 The total weight of 7 new pencils is 49 grams.

4. Mrs. Ford's math class starts at 8:15. They do 3 fluency activities that each last 4 minutes. Just when they finish all of the fluency, the fire alarm goes off. When they return to the room after the drill, it is 8:46. How many minutes did the fire drill last?

$3 \times 4 = 12$   
 $d = 3 + 15 + 1$   
 $d = 19$   
 The fire drill lasts for 19 minutes.

5. On Saturday, the baker bought a total of 150 pounds of flour in five-pound bags. By Tuesday, he had 115 pounds of flour left. How many five-pound bags of flour did the baker use?

$150$   
 $115$   
 $150$   
 $- 115$   
 $\hline 35$   
 $b = 35 \div 5$   
 $b = 7$   
 The baker used 7 five-pound bags of flour.

6. Fred cut an 84-centimeter rope into 2 parts and gave his sister 1 part. Fred's part is 56 centimeters long. His sister cut her rope into 4 equal pieces. How long is 1 of his sister's pieces of rope?

$84$   
 $56$   
 $84$   
 $- 56$   
 $\hline 28$   
 $p = 28 \div 4$   
 $p = 7$   
 One piece of Fred's sister's rope is 7 centimeters long.

Multiply.

$4 \times 1 = \underline{\quad}$      $4 \times 2 = \underline{\quad}$      $4 \times 3 = \underline{\quad}$      $4 \times 4 = \underline{\quad}$

$4 \times 5 = \underline{\quad}$      $4 \times 1 = \underline{\quad}$      $4 \times 2 = \underline{\quad}$      $4 \times 1 = \underline{\quad}$

$4 \times 3 = \underline{\quad}$      $4 \times 1 = \underline{\quad}$      $4 \times 4 = \underline{\quad}$      $4 \times 1 = \underline{\quad}$

$4 \times 5 = \underline{\quad}$      $4 \times 1 = \underline{\quad}$      $4 \times 2 = \underline{\quad}$      $4 \times 3 = \underline{\quad}$

$4 \times 2 = \underline{\quad}$      $4 \times 4 = \underline{\quad}$      $4 \times 2 = \underline{\quad}$      $4 \times 5 = \underline{\quad}$

$4 \times 2 = \underline{\quad}$      $4 \times 1 = \underline{\quad}$      $4 \times 2 = \underline{\quad}$      $4 \times 3 = \underline{\quad}$

$4 \times 1 = \underline{\quad}$      $4 \times 3 = \underline{\quad}$      $4 \times 2 = \underline{\quad}$      $4 \times 3 = \underline{\quad}$

$4 \times 4 = \underline{\quad}$      $4 \times 3 = \underline{\quad}$      $4 \times 5 = \underline{\quad}$      $4 \times 3 = \underline{\quad}$

$4 \times 4 = \underline{\quad}$      $4 \times 1 = \underline{\quad}$      $4 \times 4 = \underline{\quad}$      $4 \times 2 = \underline{\quad}$

$4 \times 4 = \underline{\quad}$      $4 \times 3 = \underline{\quad}$      $4 \times 4 = \underline{\quad}$      $4 \times 5 = \underline{\quad}$

$4 \times 4 = \underline{\quad}$      $4 \times 5 = \underline{\quad}$      $4 \times 1 = \underline{\quad}$      $4 \times 5 = \underline{\quad}$

$4 \times 2 = \underline{\quad}$      $4 \times 5 = \underline{\quad}$      $4 \times 3 = \underline{\quad}$      $4 \times 5 = \underline{\quad}$

$4 \times 4 = \underline{\quad}$      $4 \times 2 = \underline{\quad}$      $4 \times 4 = \underline{\quad}$      $4 \times 3 = \underline{\quad}$

$4 \times 5 = \underline{\quad}$      $4 \times 3 = \underline{\quad}$      $4 \times 2 = \underline{\quad}$      $4 \times 4 = \underline{\quad}$

$4 \times 3 = \underline{\quad}$      $4 \times 5 = \underline{\quad}$      $4 \times 2 = \underline{\quad}$      $4 \times 4 = \underline{\quad}$

multiply by 4 (1–5)



4. Mrs. Ford's math class starts at 8:15. They do 3 fluency activities that each last 4 minutes. Just when they finish all of the fluency activities, the fire alarm goes off. When they return to the room after the drill, it is 8:46. How many minutes did the fire drill last?
5. On Saturday, the baker bought a total of 150 pounds of flour in five-pound bags. By Tuesday, he had 115 pounds of flour left. How many five-pound bags of flour did the baker use?
6. Fred cut an 84-centimeter rope into 2 parts and gave his sister 1 part. Fred's part is 56 centimeters long. His sister cut her rope into 4 equal pieces. How long is 1 of his sister's pieces of rope?

Name \_\_\_\_\_

Date \_\_\_\_\_

Use the RDW process to solve the problem below. Use a letter to represent the unknown.

Twenty packs of fruit snacks come in a box. Each pack weighs 6 ounces. Students eat some. There are 48 ounces of fruit snacks left in the box. How many ounces of fruit snacks did the students eat?



Name \_\_\_\_\_

Date \_\_\_\_\_

Use the RDW process to solve the problems below. Use a letter to represent the unknown in each problem.

1. Jerry pours 86 milliliters of water into 8 tiny beakers. He measures an equal amount of water into the first 7 beakers. He pours the remaining water into the eighth beaker. It measures 16 milliliters. How many milliliters of water are in each of the first 7 beakers?
  
2. Mr. Chavez’s third graders go to gym class at 11:15. Students rotate through three activities for 8 minutes each. Lunch begins at 12:00. How many minutes are there between the end of gym activities and the beginning of lunch?
  
3. A box contains 100 pens. In each box there are 38 black pens and 42 blue pens. The rest are green pens. Mr. Cane buys 6 boxes of pens. How many green pens does he have in total?

4. Greg has \$56. Tom has \$17 more than Greg. Jason has \$8 less than Tom.
  - a. How much money does Jason have?
  
  
  
  
  
  
  
  
  
  
  - b. How much money do the 3 boys have in total?
  
  
  
  
  
  
  
  
  
  
5. Laura cuts 64 inches of ribbon into two parts and gives her mom one part. Laura's part is 28 inches long. Her mom cuts her ribbon into 6 equal pieces. How long is one of her mom's pieces of ribbon?

Student A

Total pencils

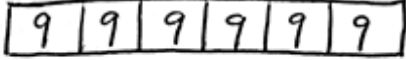

$$6 \times 9 = 54$$

Pencils she gave away

$$24 \times 2$$

$$(6 \times 4) \times 2$$

$$6 \times (4 \times 2)$$

$$6 \times 8 = 48$$

$$\begin{array}{r} 414 \\ \cancel{54} \\ - 48 \\ \hline 6 \end{array}$$

Mrs. Mashburn has 6 pencils left.

Student B

Total pencils

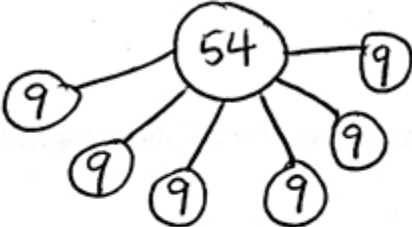

$$6 \times 9 = 54$$

Pencils she gave away

$$g = 24 \times 2$$

$$g = 48$$

$$\begin{array}{r} 24 \\ + 24 \\ \hline 48 \end{array}$$

$$\begin{array}{r} 414 \\ \cancel{54} \\ - 48 \\ \hline 6 \end{array}$$

Mrs. Mashburn has 6 pencils left.

student work samples

Student C

$$\begin{array}{r}
 414 \\
 -348 \\
 \hline
 6
 \end{array}$$

Mrs. Mashburn has 6 pencils left.

---

 student work samples



## Topic B

# Attributes of Two-Dimensional Figures

## 3.G.1

<b>Focus Standard:</b>	3.G.1	Understand that shapes in different categories (e.g., rhombuses, rectangles, and others) may share attributes (e.g., having four sides), and that the shared attributes can define a larger category (e.g., quadrilaterals). Recognize rhombuses, rectangles, and squares as examples of quadrilaterals, and draw examples of quadrilaterals that do not belong to any of these subcategories.
<b>Instructional Days:</b>	6	
<b>Coherence</b>	<b>-Links from:</b>	G2–M8 Time, Shapes, and Fractions as Equal Parts of Shapes
	<b>-Links to:</b>	G4–M4 Angle Measure and Plane Figures

In Topic B, students use their understanding of geometry from Grade 2 to explore quadrilaterals. In Lesson 4, they learn that different shapes (e.g., squares, rectangles, and rhombuses) have shared attributes that can fall within a larger category (parallelograms, quadrilaterals, and trapezoids). They explore these new, larger categories and understand, for example, that any quadrilateral can be decomposed into two triangles. As they learn which attributes are shared, the process of comparing shapes also leads to discussion about the differences between shapes; students learn, for example, that not all rectangles are squares.

Students use their understanding of the attributes of quadrilaterals to compare other polygons in Lesson 5. They look for shared attributes and learn to recognize polygons with sides that are equal—regular polygons—which helps lay a foundation for problem solving with perimeter in later topics.

While students analyze the attributes of given shapes in Lessons 4 and 5, in Lesson 6 they draw shapes based on given attributes. For example, students may be asked to draw a quadrilateral with at least two right angles and talk about which shapes are possibilities. They also draw quadrilaterals that do not fit any subcategories. Prompts such as “draw a polygon with only two sides and two angles” spark investigative discussion through which students determine the impossibility of such a shape. This lesson helps students solidify their intuitive understanding of polygons.

In Lesson 7, students work with tetrominoes. They use grid paper to construct a set and then reason about how to create larger shapes, such as rectangles, using them. This develops spatial structuring skills by way of manipulating and composing shapes.

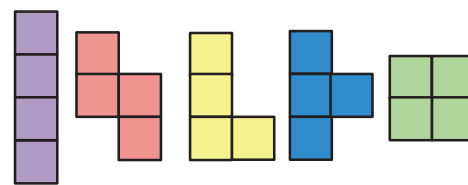

Tetrominoes

Students use their experience with composing shapes to help them decompose a square to create a tangram puzzle (pictured to the right). Lesson 8 guides students through the process of decomposing, and then reconstructing, the original square using the seven puzzle pieces.

In Lesson 9, students learn to analyze relationships between tangram pieces. For example, students might discover that the two largest triangles compose one larger triangle or that the two smallest triangles can be manipulated to compose a small square, parallelogram, or medium triangle.

Students solve tangram puzzles using their pieces and discuss whether or not there is more than one way to compose a given polygon. Describing their strategies provides engaging context for using the vocabulary of attributes: “I found that the right angle of the small triangle forms the top of the duck’s head.” Students may create their own polygons and trade with partners to see if a peer can use their tangram pieces to complete the outline.

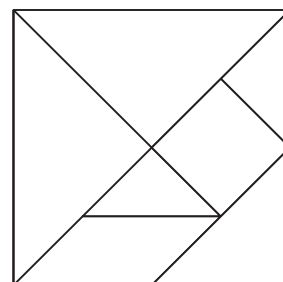

Tangram



### A Teaching Sequence Toward Mastery of Attributes of Two-Dimensional Figures

**Objective 1: Compare and classify quadrilaterals.**  
(Lesson 4)

**Objective 2: Compare and classify other polygons.**  
(Lesson 5)

**Objective 3: Draw polygons with specified attributes to solve problems.**  
(Lesson 6)

**Objective 4: Reason about composing and decomposing polygons using tetrominoes.**  
(Lesson 7)

**Objective 5: Create a tangram puzzle and observe relationships among the shapes.**  
(Lesson 8)

**Objective 6: Reason about composing and decomposing polygons using tangrams.**  
(Lesson 9)

## Lesson 4

Objective: Compare and classify quadrilaterals.

### Suggested Lesson Structure

■ Fluency Practice	(12 minutes)
■ Application Problem	(7 minutes)
■ Concept Development	(31 minutes)
■ Student Debrief	(10 minutes)
<b>Total Time</b>	<b>(60 minutes)</b>

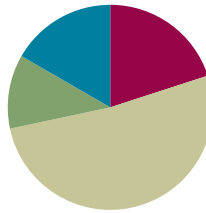

### Fluency Practice (12 minutes)

- Multiply by 4 **3.OA.7** (8 minutes)
- Equivalent Counting with Units of 5 **3.OA.7** (4 minutes)

### Multiply by 4 (8 minutes)

Materials: (S) Multiply by 4 (6–10) Pattern Sheet

Note: This activity builds fluency with multiplication facts using units of 4. It works toward students knowing from memory all products of two one-digit numbers. See Lesson 1 for the directions for administration of a Multiply-By Pattern Sheet.

T: (Write  $7 \times 4 = \underline{\quad}$ .) Let's skip-count up by fours. I'll raise a finger for each four. (Raise a finger for each number to track the count.)

S: 4, 8, 12, 16, 20, 24, 28.

T: Let's skip-count up by fours starting at 20. Why is 20 a good place to start?

S: It's a fact we already know, so we can use it to figure out a fact we don't know.

T: (Track with fingers as students say the numbers.)

S: 20 (5 fingers), 24 (6 fingers), 28 (7 fingers).

T: Let's see how we can skip-count down to find the answer, too. Start at 40 with 10 fingers, 1 for each four. (Count down with fingers as students say the numbers.)

S: 40 (10 fingers), 36 (9 fingers), 32 (8 fingers), 28 (7 fingers).

Continue with the following possible sequence:  $9 \times 4$ ,  $6 \times 4$ , and  $8 \times 4$ .

T: (Distribute the Multiply by 4 Pattern Sheet.) Let's practice multiplying by 4. Be sure to work left to right across the page.

### Equivalent Counting with Units of 5 (4 minutes)

Note: This activity builds fluency with multiplication facts using units of 5. The progression builds in complexity. Work students up to the highest level where they can confidently participate.

T: Count to 10. (Write as students count. See the chart below.)

S: 1, 2, 3, 4, 5, 6, 7, 8, 9, 10.

1	2	3	4	5	6	7	8	9	10
1 five	2 fives	3 fives	4 fives	5 fives	6 fives	7 fives	8 fives	9 fives	10 fives
5	10	15	20	25	30	35	40	45	50
1 five	10	3 fives	20	5 fives	30	7 fives	40	9 fives	50
5	2 fives	15	4 fives	25	6 fives	35	8 fives	45	10 fives

T: (Write 1 five beneath the 1.) Count to 10 fives. (Write as students count.)

S: 1 five, 2 fives, 3 fives, 4 fives, 5 fives, 6 fives, 7 fives, 8 fives, 9 fives, 10 fives.

T: Count by fives to 50. (Write as students count.)

S: 5, 10, 15, 20, 25, 30, 35, 40, 45, 50.

T: (Write 1 five beneath the 5. Write 10 beneath the 10.) I'm going to give you a challenge. Let's alternate between saying the units of five and the number. (Write as students count.)

S: 1 five, 10, 3 fives, 20, 5 fives, 30, 7 fives, 40, 9 fives, 50.

T: (Write 5 beneath 1 five and 2 fives beneath the 10.) Let's alternate again. (Write as students count.)

S: 5, 2 fives, 15, 4 fives, 25, 6 fives, 35, 8 fives, 45, 10 fives.

### Application Problem (7 minutes)

The third graders raised \$437 in a fundraiser. The fourth graders raised \$68 less than the third graders. How much money did the two grade levels raise altogether?

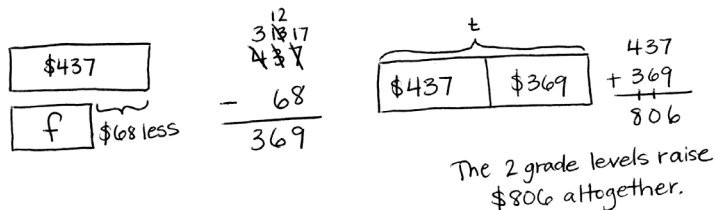

$$\begin{array}{r} 437 \\ - 68 \\ \hline 369 \end{array}$$

$$\begin{array}{r} 437 \\ + 369 \\ \hline 806 \end{array}$$

The 2 grade levels raise \$806 altogether.

Note: This problem reviews two-step word problems from Topic A.



#### NOTES ON MULTIPLE MEANS OF REPRESENTATION:

Modeling a tape diagram for the money fourth graders raise, as well as the total money raised, helps English language learners and students working below grade level better grasp the meaning of the phrase *\$68 less than the third graders*. Ask, "Who raised less money? Did the fourth graders raise \$68? Use the model to estimate about how much the fourth graders raised."



### Concept Development (31 minutes)

Materials: (T) 2 rulers (S) Index card for use as right angle tool, polygons (A–L) (Template), ruler, Problem Set, scissors

#### Part 1: Group polygons by attributes.

Pass out the index cards and Template.

- T: We'll use these cards as tools. Put a finger on each corner.
- S: (Touch each corner.)
- T: Remember from second grade that we call the point where sides meet to make a corner an *angle*. These are **right angles** because they have square corners. We'll use our cards as right angle tools to help us find other shapes that have right angles. (Save the right angle tools for the entire module.)
- T: Now, cut out shapes A–L on your template.
- S: (Cut.)
- T: Look at your shapes. Discuss with a partner: What are some different ways we can group these shapes together?
- S: We can group them by name, like all the squares together. → We can group them by the number of sides. → We can also group them by the number of angles.
- T: Remember from second grade that closed shapes like these that have no gaps or overlaps between the straight sides are called **polygons**. Polygons with four straight sides are called **quadrilaterals**. Tell your partner what a quadrilateral is, and then find and group the quadrilaterals.
- S: A quadrilateral is a polygon with four sides. (Group the quadrilaterals.)
- T: What do you notice about the polygons you grouped?
- S: They don't look the same. → Some are slanted, and some are boxy. → Some are squares and rectangles, but others are strange looking. → One polygon even looks like a boomerang. → They have four angles.
- T: The polygons look different, but they share the attributes of having four sides and four angles. Complete the first row of the chart on the Problem Set. Make sure to sketch one polygon from the group.



#### NOTES ON VOCABULARY:

All of the bold-type terms in this lesson were introduced in Grade 2 Module 8. However, given the specificity of the words and the time that has passed since students' work in Grade 2 Module 8, it may be best to approach teaching the vocabulary as if it were new.



#### NOTES ON MULTIPLE MEANS OF REPRESENTATION:

Clarify for English language learners and others the term *group*. In past modules, they have *grouped* like units, such as 10 tens to make 100 or 3 fives to make 15. Here, *grouping* does not mean bundling units that are exactly the same but rather sorting polygons by one or more shared attribute.

4-sided:

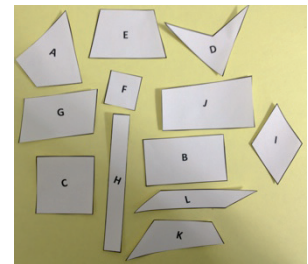

- T: Next, we'll find and group **trapezoids**. These are quadrilaterals that have at least one set of **parallel** sides. Think of parallel sides like the two side lines of a capital *H*, or a slanted *H*, since not all parallel sides stand vertical. (Demonstrate using two rulers.) Imagine these two lines go on forever. Do you think they will ever cross? Why or why not?
- S: I don't think they will cross. → No, they won't cross because they're straight and going in the same direction all the time.
- T: (Slant the rulers so they are not parallel anymore but are still not touching.) These lines are not touching. Are they parallel? Why or why not?
- S: No. The sides don't look like an *H* anymore. → If we imagine the lines keep going, they will eventually cross!
- T: If trapezoids must have *at least* one set of parallel sides, can they have more than one set?
- S: Yeah. *At least* means one or more.
- T: Group the trapezoids. Complete the second row of the chart on the Problem Set. Make sure to sketch one polygon from the group.
- S: (Group all shapes, except A, D, and K, and sketch one shape.)
- T: What do you notice about the polygons you grouped?
- S: I found a bunch! → No. There's only one shape that has only one set of parallel sides. Polygon E! → Remember, though, a trapezoid has *at least* one set! That's almost all of them!
- T: Now we'll find and group **parallelograms**. These are four-sided polygons that have two sets of parallel sides.
- T: Group the parallelograms. Then, complete the next row of the chart on your Problem Set.
- S: (Group the polygons, and complete the chart.)
- T: Now, use your right angle tool to measure and group all the polygons that have four right angles. Then, complete the chart.
- S: (Measure, group, and complete the chart.)
- T: Next, find and group all the squares. Which attributes make squares special?
- S: They have four equal sides and four right angles.
- T: Use your ruler and right angle tool to confirm that with these polygons. Then, complete the chart.
- S: (Measure, group, and complete the chart.)



### NOTES ON TRAPEZOIDS:

According to the K–6 Geometry Progressions, the term *trapezoid* can have two different meanings:

- Exclusive Definition: A trapezoid is a quadrilateral with exactly one pair of parallel sides.
- Inclusive Definition: A trapezoid is a quadrilateral with at least one pair of parallel sides.

*A Story of Units* uses the inclusive definition. Therefore, a parallelogram is also considered a trapezoid.

2 parallel sides:

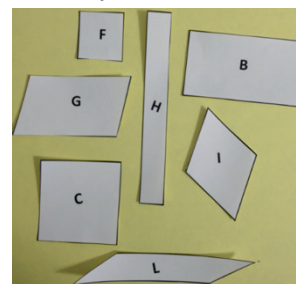

4 right angles:

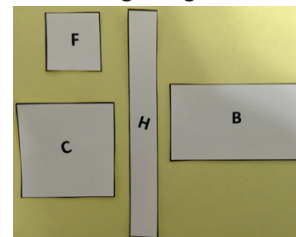

Squares:

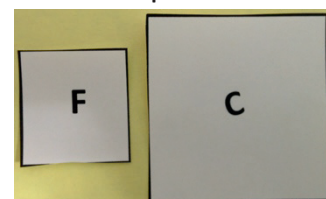

**Part 2: Analyze quadrilaterals.**

- T: In our set of polygons A–L, did the number of polygons get smaller or larger as we added attributes?
- S: It got smaller.
- T: Discuss with your partner why you think the number of polygons in each group got smaller as we added attributes.
- S: I think it's because the attributes in our chart become more special. The last category only includes the most special polygon, a square, because it has to have four right angles *and* four equal sides.  
→ Each time we added a new attribute, fewer polygons belonged to the group.
- T: As the attributes become more specific, fewer shapes in our set share all of the attributes. Look at Polygons C and F. They are included in every group. Why do you think that is?
- S: They have four sides, two sets of parallel lines, and four right angles.
- T: Why aren't Polygons B and H included in the last category? These specific rectangles have four sides, two sets of parallel lines, and four right angles.
- S: Polygons B and H don't have all equal sides.
- T: Look at Polygon I. It has four equal sides and two sets of parallel lines. Why isn't it included in the last category?
- S: It doesn't have four right angles. → It needs to have them all, not just one attribute.
- T: Let's make a new category, one that has shapes with 4 equal sides. Work with your partner.
- T: (Move Polygons C, F, and I to form a new group.) A shape with 4 equal sides is called a **rhombus**.
- T: Why is a square a rhombus?
- S: Because it has 4 equal sides!
- T: Why isn't shape I a square?
- S: Because it doesn't have right angles!

**MP.3****Part 3: Decompose quadrilaterals into two triangles.**

- T: Problem 4 asks you to use a straightedge to draw a line between opposite corners in each quadrilateral you drew in the chart. This kind of line is called a **diagonal** line. Do that now.
- S: (Draw diagonals in each polygon.)
- T: Which new polygons did you make by drawing the diagonal line?
- S: Triangles.
- T: Complete Problem 4 on your Problem Set.
- T: Pick other polygons we used that you did not draw on your chart. Draw diagonal lines inside the polygons. Do you still get two triangles? (Allow time for students to draw.)
- S: Yes!
- T: All quadrilaterals are made up of two triangles.

Students should now go back and finish Problems 2 and 3 on the Problem Set.

## Student Debrief (10 minutes)

**Lesson Objective:** Compare and classify quadrilaterals.

The Student Debrief is intended to invite reflection and active processing of the total lesson experience.

Invite students to review their solutions for the Problem Set. They should check work by comparing answers with a partner before going over answers as a class. Look for misconceptions or misunderstandings that can be addressed in the Debrief. Guide students in a conversation to debrief the Problem Set and process the lesson.

Any combination of the questions below may be used to lead the discussion.

- How does grouping quadrilaterals by **attributes**, like you did in Problem 1, help us see the similarities and differences between the **polygons**?
- Share sketches of parallelograms from Problem 3. Have students describe **parallel** lines through their color-coded tracing.
- For Problem 4, share drawings of different quadrilaterals to reinforce how every quadrilateral can be decomposed into two triangles.
- What math vocabulary did we use today to name polygons with four sides? (**Quadrilateral.**) At least one set of parallel sides? (**Trapezoid.**) Two sets of parallel sides? (**Parallelogram.**) A shape with 4 equal sides? (**Rhombus.**) An angle that makes square corners? (**Right angle.**) The line between opposite corners in each quadrilateral? (**Diagonal.**)

## Exit Ticket (3 minutes)

After the Student Debrief, instruct students to complete the Exit Ticket. A review of their work will help with assessing students' understanding of the concepts that were presented in today's lesson and planning more effectively for future lessons. The questions may be read aloud to the students.

Name Gina Date \_\_\_\_\_

1. Cut out all the polygons (A–L) in the template. Then use the polygons to complete the following chart.

Attribute	Write the letters of the polygons in this group.	Sketch 1 polygon from the group.
Example: 3 Sides	Polygons: Y, Z	
4 Sides	Polygons: A, B, C, D, E, F, G, H, I, J, K, L All of them!	
At Least 1 Set of Parallel Sides	Polygons: B, C, E, F, G, H, I, J, L	
2 Sets of Parallel Sides	Polygons: B, C, F, G, H, I, L	
4 Right Angles	Polygons: B, C, F, H	
4 Right Angles and 4 Equal Sides	Polygons: C, F	

2. Write the letters of the polygons that are quadrilaterals. Explain how you know these polygons are quadrilaterals. *All of the polygons A–L are quadrilaterals because they all have 4 sides.*

3. Sketch a polygon from the group that has 2 sets of parallel sides below. Trace 1 pair of parallel sides red. Trace the other pair of parallel sides blue. What makes parallel sides different from sides that are not parallel? *The parallel sides look like the 2 sides of a big H. They'll never touch or cross, even if we make them longer and longer.*

4. Draw a diagonal line from one corner to the opposite corner of each polygon you drew in the chart using a straightedge. What new polygon(s) did you make by drawing the diagonal lines? *I made 2 triangles in each shape!*

Multiply.

$4 \times 1 = \underline{\quad\quad}$      $4 \times 2 = \underline{\quad\quad}$      $4 \times 3 = \underline{\quad\quad}$      $4 \times 4 = \underline{\quad\quad}$

$4 \times 5 = \underline{\quad\quad}$      $4 \times 6 = \underline{\quad\quad}$      $4 \times 7 = \underline{\quad\quad}$      $4 \times 8 = \underline{\quad\quad}$

$4 \times 9 = \underline{\quad\quad}$      $4 \times 10 = \underline{\quad\quad}$      $4 \times 5 = \underline{\quad\quad}$      $4 \times 6 = \underline{\quad\quad}$

$4 \times 5 = \underline{\quad\quad}$      $4 \times 7 = \underline{\quad\quad}$      $4 \times 5 = \underline{\quad\quad}$      $4 \times 8 = \underline{\quad\quad}$

$4 \times 5 = \underline{\quad\quad}$      $4 \times 9 = \underline{\quad\quad}$      $4 \times 5 = \underline{\quad\quad}$      $4 \times 10 = \underline{\quad\quad}$

$4 \times 6 = \underline{\quad\quad}$      $4 \times 5 = \underline{\quad\quad}$      $4 \times 6 = \underline{\quad\quad}$      $4 \times 7 = \underline{\quad\quad}$

$4 \times 6 = \underline{\quad\quad}$      $4 \times 8 = \underline{\quad\quad}$      $4 \times 6 = \underline{\quad\quad}$      $4 \times 9 = \underline{\quad\quad}$

$4 \times 6 = \underline{\quad\quad}$      $4 \times 7 = \underline{\quad\quad}$      $4 \times 6 = \underline{\quad\quad}$      $4 \times 7 = \underline{\quad\quad}$

$4 \times 8 = \underline{\quad\quad}$      $4 \times 7 = \underline{\quad\quad}$      $4 \times 9 = \underline{\quad\quad}$      $4 \times 7 = \underline{\quad\quad}$

$4 \times 8 = \underline{\quad\quad}$      $4 \times 6 = \underline{\quad\quad}$      $4 \times 8 = \underline{\quad\quad}$      $4 \times 7 = \underline{\quad\quad}$

$4 \times 8 = \underline{\quad\quad}$      $4 \times 9 = \underline{\quad\quad}$      $4 \times 9 = \underline{\quad\quad}$      $4 \times 6 = \underline{\quad\quad}$

$4 \times 9 = \underline{\quad\quad}$      $4 \times 7 = \underline{\quad\quad}$      $4 \times 9 = \underline{\quad\quad}$      $4 \times 8 = \underline{\quad\quad}$

$4 \times 9 = \underline{\quad\quad}$      $4 \times 8 = \underline{\quad\quad}$      $4 \times 6 = \underline{\quad\quad}$      $4 \times 9 = \underline{\quad\quad}$

$4 \times 7 = \underline{\quad\quad}$      $4 \times 9 = \underline{\quad\quad}$      $4 \times 6 = \underline{\quad\quad}$      $4 \times 8 = \underline{\quad\quad}$

$4 \times 9 = \underline{\quad\quad}$      $4 \times 7 = \underline{\quad\quad}$      $4 \times 6 = \underline{\quad\quad}$      $4 \times 8 = \underline{\quad\quad}$

---

multiply by 4 (6–10)

Name \_\_\_\_\_

Date \_\_\_\_\_

1. Cut out all the polygons (A–L) in the Template. Then, use the polygons to complete the following chart.

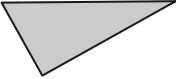
Attribute	Write the letters of the polygons in this group.	Sketch 1 polygon from the group.
<i>Example:</i> <b>3 Sides</b>	Polygons: Y, Z	
<b>4 Sides</b>	Polygons:	
<b>At Least 1 Set of Parallel Sides</b>	Polygons:	
<b>2 Sets of Parallel Sides</b>	Polygons:	
<b>4 Right Angles</b>	Polygons:	
<b>4 Right Angles and 4 Equal Sides</b>	Polygons:	

- Write the letters of the polygons that are quadrilaterals. Explain how you know these polygons are quadrilaterals.
- Sketch a polygon below from the group that has 2 sets of parallel sides. Trace 1 pair of parallel sides red. Trace the other pair of parallel sides blue. What makes parallel sides different from sides that are not parallel?
- Draw a diagonal line from one corner to the opposite corner of each polygon you drew in the chart using a straightedge. What new polygon(s) did you make by drawing the diagonal lines?

Name \_\_\_\_\_

Date \_\_\_\_\_

List as many attributes as you can to describe each polygon below.

1.

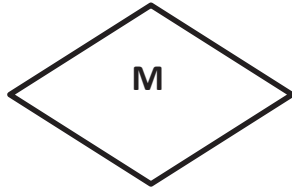

2.







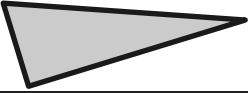
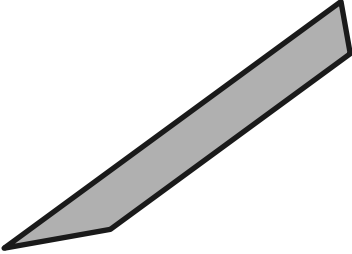

Name \_\_\_\_\_

Date \_\_\_\_\_

1. Complete the chart by answering true or false.

Attribute	Polygon	True or False
<i>Example:</i> 3 Sides		True
4 Sides		
2 Sets of Parallel Sides		
4 Right Angles		
Quadrilateral		

2. a. Each quadrilateral below has at least 1 set of parallel sides. Trace each set of parallel sides with a colored pencil.

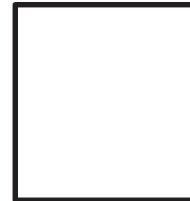

- b. Using a straightedge, sketch a different quadrilateral with at least 1 set of parallel sides.

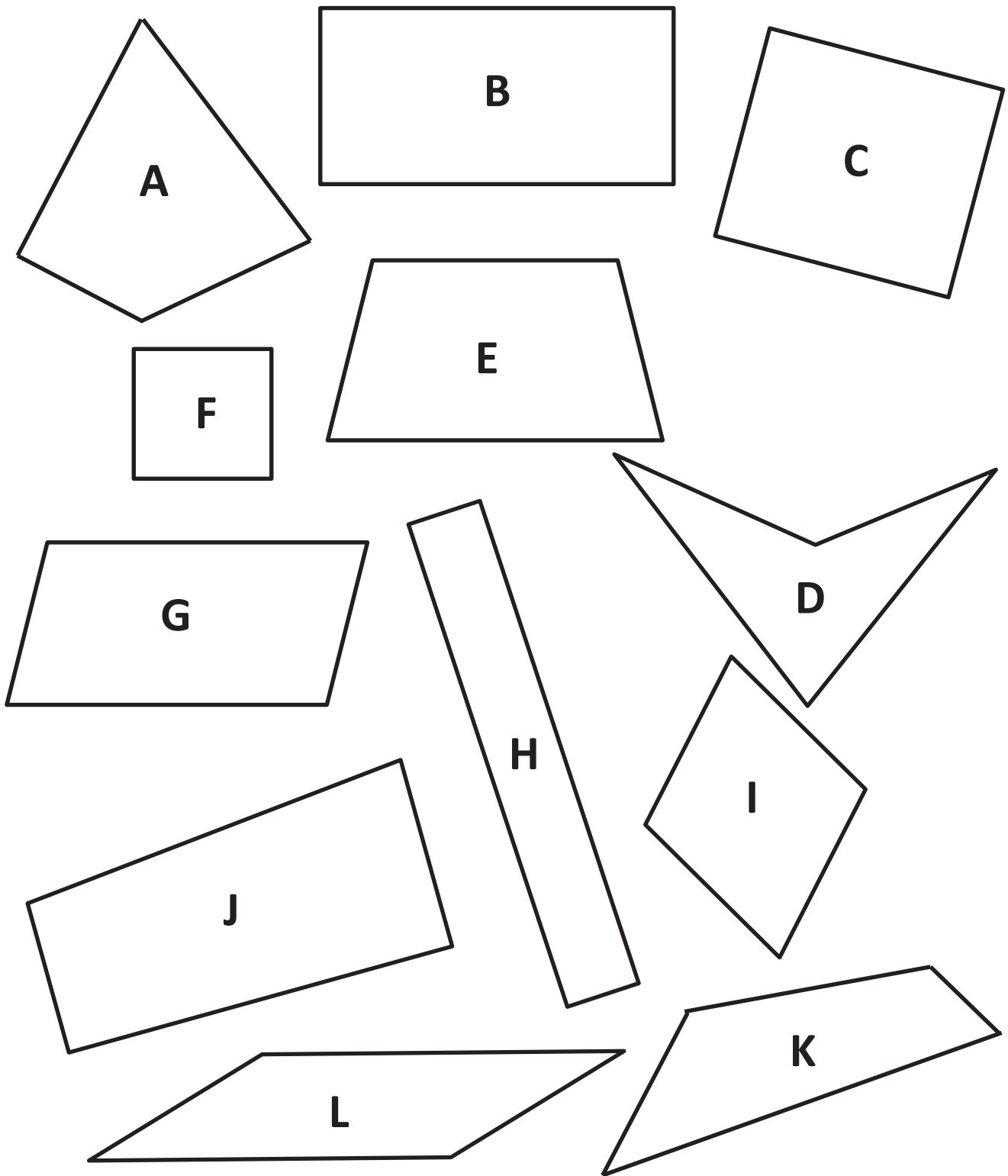

---

polygons (A–L)

## Lesson 5

Objective: Compare and classify other polygons.

### Suggested Lesson Structure

■ Fluency Practice	(15 minutes)
■ Concept Development	(35 minutes)
■ Student Debrief	(10 minutes)
<b>Total Time</b>	<b>(60 minutes)</b>

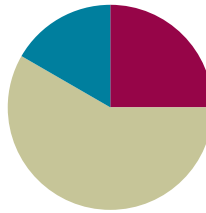

### Fluency Practice (15 minutes)

- Multiply by 5 **3.OA.7** (7 minutes)
- Equivalent Counting with Units of 6 **3.OA.7** (4 minutes)
- Classify the Polygon **3.G.1** (4 minutes)

### Multiply by 5 (7 minutes)

Materials: (S) Multiply by 5 (1–5) Pattern Sheet

Note: This activity builds fluency with multiplication facts using units of 5. It works toward students knowing from memory all products of two one-digit numbers. See Lesson 1 for the directions for administration of a Multiply-By Pattern Sheet.

T: (Write  $5 \times 5 = \underline{\quad}$ .) Let's skip-count up by fives to find the answer. (Raise a finger for each number to track the count. Record the skip-count answers on the board.)

S: 5, 10, 15, 20, 25.

T: (Circle 25, and write  $5 \times 5 = 25$  above it. Write  $3 \times 5 = \underline{\quad}$ .) Let's skip-count up by fives again. (Track with fingers as students count.)

S: 5 (one finger), 10 (two fingers), 15 (three fingers).

T: Let's see how we can skip-count down to find the answer, too. Start at 25 with 5 fingers, 1 for each five. (Count down with fingers as students say the numbers.)

S: 25 (five fingers), 20 (4 fingers), 15 (3 fingers).

Repeat the process for  $4 \times 5$ .

T: (Distribute the Multiply by 5 Pattern Sheet.) Let's practice multiplying by 5. Be sure to work left to right across the page.

### Equivalent Counting with Units of 6 (4 minutes)

Note: This activity builds fluency with multiplication facts using units of 6. The progression builds in complexity. Work students up to the highest level of complexity where they can confidently participate.

T: Count to 10. (Write as students count. See the chart below.)

S: 1, 2, 3, 4, 5, 6, 7, 8, 9, 10.

1	2	3	4	5	6	7	8	9	10
1 six	2 sixes	3 sixes	4 sixes	5 sixes	6 sixes	7 sixes	8 sixes	9 sixes	10 sixes
6	12	18	24	30	36	42	48	54	60
1 six	12	3 sixes	24	5 sixes	36	7 sixes	48	9 sixes	60
6	2 sixes	18	4 sixes	30	6 sixes	42	8 sixes	54	10 sixes

T: (Write 1 six beneath the 1.) Count to 10 sixes. (Write as students count.)

S: 1 six, 2 sixes, 3 sixes, 4 sixes, 5 sixes, 6 sixes, 7 sixes, 8 sixes, 9 sixes, 10 sixes.

T: Count by sixes to 60. (Write as students count.)

S: 6, 12, 18, 24, 30, 36, 42, 48, 54, 60.

T: (Write 1 six beneath the 6. Write 12 beneath the 12.) I'm going to give you a challenge. Let's alternate between saying the units of six and the number. (Write as students count.)

S: 1 six, 12, 3 sixes, 24, 5 sixes, 36, 7 sixes, 48, 9 sixes, 60.

T: (Write 6 beneath 1 six and 2 sixes beneath the 12.) Let's alternate again. (Write as students count.)

S: 6, 2 sixes, 18, 4 sixes, 30, 6 sixes, 42, 8 sixes, 54, 10 sixes.

### Classify the Polygon (4 minutes)

Materials: (S) Personal white board

Note: This activity reviews identifying attributes and naming polygons.

T: (Project a trapezoid.) How many sides does this polygon have?

S: Four sides.

T: What do we call polygons that have four sides?

S: Quadrilaterals.

T: How many sets of parallel lines does this quadrilateral have?

S: One set.

T: What do we call quadrilaterals that have at least one set of parallel lines?

S: Trapezoids.



#### NOTES ON MULTIPLE MEANS OF ENGAGEMENT:

English language learners and others who may not be able to quickly articulate the names of polygons might benefit from adjusting the questions. For example, ask, "Is this a quadrilateral? How many sides does a quadrilateral have?"

T: (Project a parallelogram with no right angles.) Is this polygon a quadrilateral?

S: Yes.

T: How many right angles does this particular quadrilateral have?

S: Zero right angles.

T: Is this quadrilateral a trapezoid?

S: Yes.

T: Why?

S: It has at least one set of parallel lines.

T: How many sets of parallel sides does it have?

S: Two sets of parallel sides.

T: What do we call all quadrilaterals that have two sets of parallel sides?

S: Parallelograms.

T: (Project a rectangle that is not a square.) Is this polygon a quadrilateral?

S: Yes.

T: Write how many right angles this quadrilateral has.

S: (Write 4.)

T: Is this quadrilateral a trapezoid?

S: Yes.

T: Why?

S: It has at least one set of parallel lines.

T: Is this trapezoid also a parallelogram?

S: Yes.

T: Why?

S: It has two sets of parallel sides.

T: Is this parallelogram also a rectangle?

S: Yes.

T: Why?

S: It has two sets of parallel sides and four right angles.

T: (Project a rhombus that is not a square.) Is this polygon a quadrilateral?

S: Yes.

T: Why?

S: It has four sides.

T: Write how many right angles this quadrilateral has.

S: (Write 0.)

T: Is this quadrilateral a trapezoid?

S: Yes.

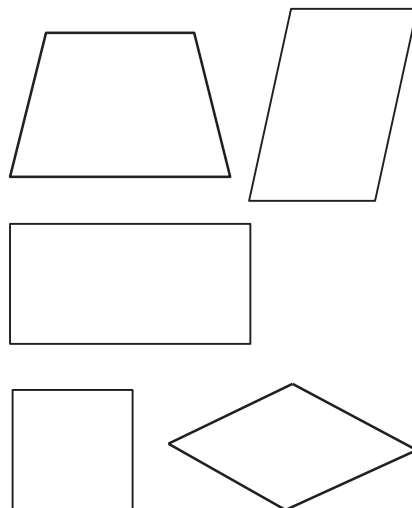

- T: Why?
- S: It has at least one set of parallel lines.
- T: Is this trapezoid also a parallelogram?
- S: Yes.
- T: Why?
- S: It has two sets of parallel sides.
- T: Is this parallelogram also a rectangle?
- S: No.
- T: Why?
- S: It has two sets of parallel sides but no right angles.
- T: The sides of this parallelogram are equal. What do we call a parallelogram with 4 equal sides?
- S: A rhombus.
- T: What is a rhombus with 4 right angles called?
- S: A square!
- T: How else can a square be classified?
- S: Trapezoid. → Quadrilateral. → Rectangle. → Parallelogram. → Polygon.

### Concept Development (35 minutes)

Materials: (S) Right angle tool, Polygons M–X (Template), ruler, Problem Set, scissors

#### Problem 1: Group polygons by attributes.

- T: Look at Polygons M–X. Compare them with yesterday’s polygons. What do you notice?
- S: Now there are many different kinds of polygons. → All of the polygons aren’t quadrilaterals. I see triangles, some quadrilaterals, hexagons, and funny looking polygons, too.
- T: Take out your right angle tools and rulers.
- S: (Take out the tools.)
- T: Look at the chart on your Problem Set. Yesterday we grouped polygons with four sides. Today we’re first going to group polygons with all equal sides. What tools will we need to make sure our work is precise?
- S: A ruler. → A centimeter ruler. → An inch ruler.
- T: Look at your ruler, and talk to a partner. Which unit will be the most precise: inches, half inches, quarter inches, or centimeters?
- S: Inches are the biggest unit, so they won’t be the most precise. → Half inches and centimeters are smaller than inches. → A quarter inch is even smaller than a half inch and a centimeter. → We should use the quarter inch because it’s the smallest unit, so it will be the most precise.
- T: Work with your partner to measure the sides of all of your polygons to the nearest quarter inch. Label the inside side lengths to help you remember. Then, cut out Polygons M–X.
- S: (Measure, label, and cut.)

MP.6

- T: Group into categories of *all sides are equal* and *not all sides are equal*. Then, complete the first two sections of your chart.
- S: (Group and complete the chart.)
- T: Did you group each of your polygons into one of the categories?
- S: Yes!
- T: The next two parts of our chart start with the words *at least 1*. When it says *at least 1*, can the polygon have more than one?
- S: Yes. It just means that you need to have one for sure.
- T: Use your right angle tool to measure, and group the polygons that have at least 1 right angle.

Have students complete the rest of the chart. Circulate to look for and correct any misconceptions.

- T: Let's examine the polygons that have all equal sides more closely. Look at Polygon S. What do you know about the side lengths?
- S: They're all the same!
- T: What do you know about the angles?
- S: They're all right angles. → So, the angles are all the same, too!
- T: A polygon with all equal sides and all equal angles is called a **regular polygon**. (Project the polygon as shown.) How many sides does this polygon have?
- S: Five sides!
- T: What do we call a polygon with five sides?
- S: A pentagon!
- T: Talk to a partner. Is this a regular pentagon?
- S: All the sides are equal. → But it doesn't look like all the angles are equal. → Yeah. It looks like there are two right angles, but the angle at the top looks smaller than a right angle. → So, this pentagon can't be a regular pentagon!
- T: You're right! This isn't a regular pentagon because the sides are all equal, but the angles aren't all equal.

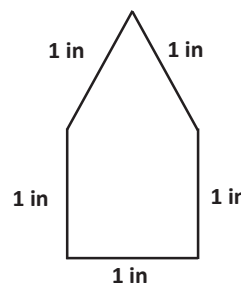

### Problem 2: Compare polygons.

- T: Count each polygon's sides. Then, write the number of sides under the polygon's letter. Do that now. (Allow students time to finish.) Now, group the polygons with the same number of sides.
- S: (Group.)
- T: Compare the polygons in each group. Are they the same type of polygon? For example, Polygon U is a six-sided polygon, or a hexagon. Polygon T also has six sides. Is Polygon T a hexagon, too?
- S: Polygon T doesn't look like a hexagon. → They are both still hexagons. It's just that Polygon U has all equal sides. That's why it looks like the more familiar one.
- T: It's true. Remember we saw all different types of quadrilaterals. Some looked familiar to us, like a square or rectangle, and others were more unusual. But they all had four sides and were all still quadrilaterals.



- T: Now, spread out your polygons. I'll call out an attribute. You hold up a polygon that fits the attribute. Ready? Show a polygon that does not have *all* equal sides.
- S: (Show Polygon N, O, R, T, Q, V, or X.)
- T: Show a polygon that has *exactly* one right angle.
- S: (Show Polygon Q.)
- T: Show a polygon that has four equal sides.
- S: (Show Polygon S.)
- T: Show a polygon that has only one set of parallel lines.
- S: (Show Polygon R.)
- T: Here's a challenge. Show a polygon that has exactly three sets of parallel lines.
- S: (Show Polygon U.)

Have students finish the rest of the Problem Set independently.

### Student Debrief (10 minutes)

**Lesson Objective:** Compare and classify other polygons.

The Student Debrief is intended to invite reflection and active processing of the total lesson experience.





Invite students to review their solutions for the Problem Set. They should check work by comparing answers with a partner before going over answers as a class. Look for misconceptions or misunderstandings that can be addressed in the Debrief. Guide students in a conversation to debrief the Problem Set and process the lesson.

Any combination of the questions below may be used to lead the discussion.

- Share student work for Problem 3, and compare the three quadrilaterals. Which attributes are the same and different?

Name Gina Date \_\_\_\_\_

1. Cut out all the polygons (M-X) in the template. Then, use the polygons to complete the following chart.

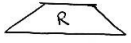
Attribute	List polygons' letters for each group.	Sketch 1 polygon from the group.
Example: 3 Sides	Polygons: Y, Z	
All Sides are Equal	Polygons: M, P, S, U, W	
All Sides are Not Equal	Polygons: N, O, R, T, Q, V, X	
At Least 1 Right Angle	Polygons: N, Q, T, S	
At Least 1 Set of Parallel Sides	Polygons: M, N, R, P, S, U, T, X	

2. Compare Polygon M and Polygon X. What is the same? What is different?

They both have 8 sides, so they are both octagons. But Polygon M has all equal sides and Polygon X has sides that are not all equal.

3. Jenny says, "Polygon N, Polygon R, and Polygon S are all regular quadrilaterals!" Is she correct? Why or why not?

No, Jenny is not correct. A regular quadrilateral has 4 equal sides and 4 equal angles. Only Polygon S is a regular quadrilateral.

4. "I have six equal sides and six equal angles. I have three sets of parallel lines. I have no right angles."

- a. Write the letter and the name of the polygon described above.

Polygon U is a regular hexagon.

- b. Estimate to draw the same type of polygon as in part (a), but with no equal sides.

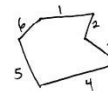

- Compare student sketches in Problem 4(b). Continue to have students draw different polygons on their personal white boards while the teacher calls out different attributes. For example, “Sketch a pentagon with no equal sides; sketch a triangle with one right angle.” Have students compare polygons to understand that polygons are defined by the number of sides, not just how they look.
- Was it easier to group quadrilaterals or group polygons with different numbers of sides? Why?
- Tell your partner two attributes of a **regular polygon**. Which quadrilateral is a regular polygon?
- How did today’s Fluency Practice connect to the lesson?

### Exit Ticket (3 minutes)

After the Student Debrief, instruct students to complete the Exit Ticket. A review of their work will help with assessing students’ understanding of the concepts that were presented in today’s lesson and planning more effectively for future lessons. The questions may be read aloud to the students.

Multiply.

$5 \times 1 = \underline{\quad\quad}$      $5 \times 2 = \underline{\quad\quad}$      $5 \times 3 = \underline{\quad\quad}$      $5 \times 4 = \underline{\quad\quad}$

$5 \times 5 = \underline{\quad\quad}$      $5 \times 1 = \underline{\quad\quad}$      $5 \times 2 = \underline{\quad\quad}$      $5 \times 1 = \underline{\quad\quad}$

$5 \times 3 = \underline{\quad\quad}$      $5 \times 1 = \underline{\quad\quad}$      $5 \times 4 = \underline{\quad\quad}$      $5 \times 1 = \underline{\quad\quad}$

$5 \times 5 = \underline{\quad\quad}$      $5 \times 1 = \underline{\quad\quad}$      $5 \times 2 = \underline{\quad\quad}$      $5 \times 3 = \underline{\quad\quad}$

$5 \times 2 = \underline{\quad\quad}$      $5 \times 4 = \underline{\quad\quad}$      $5 \times 2 = \underline{\quad\quad}$      $5 \times 5 = \underline{\quad\quad}$

$5 \times 2 = \underline{\quad\quad}$      $5 \times 1 = \underline{\quad\quad}$      $5 \times 2 = \underline{\quad\quad}$      $5 \times 3 = \underline{\quad\quad}$

$5 \times 1 = \underline{\quad\quad}$      $5 \times 3 = \underline{\quad\quad}$      $5 \times 2 = \underline{\quad\quad}$      $5 \times 3 = \underline{\quad\quad}$

$5 \times 4 = \underline{\quad\quad}$      $5 \times 3 = \underline{\quad\quad}$      $5 \times 5 = \underline{\quad\quad}$      $5 \times 3 = \underline{\quad\quad}$

$5 \times 4 = \underline{\quad\quad}$      $5 \times 1 = \underline{\quad\quad}$      $5 \times 4 = \underline{\quad\quad}$      $5 \times 2 = \underline{\quad\quad}$

$5 \times 4 = \underline{\quad\quad}$      $5 \times 3 = \underline{\quad\quad}$      $5 \times 4 = \underline{\quad\quad}$      $5 \times 5 = \underline{\quad\quad}$

$5 \times 4 = \underline{\quad\quad}$      $5 \times 5 = \underline{\quad\quad}$      $5 \times 1 = \underline{\quad\quad}$      $5 \times 5 = \underline{\quad\quad}$

$5 \times 2 = \underline{\quad\quad}$      $5 \times 5 = \underline{\quad\quad}$      $5 \times 3 = \underline{\quad\quad}$      $5 \times 5 = \underline{\quad\quad}$

$5 \times 4 = \underline{\quad\quad}$      $5 \times 2 = \underline{\quad\quad}$      $5 \times 4 = \underline{\quad\quad}$      $5 \times 3 = \underline{\quad\quad}$

$5 \times 5 = \underline{\quad\quad}$      $5 \times 3 = \underline{\quad\quad}$      $5 \times 2 = \underline{\quad\quad}$      $5 \times 4 = \underline{\quad\quad}$

$5 \times 3 = \underline{\quad\quad}$      $5 \times 5 = \underline{\quad\quad}$      $5 \times 2 = \underline{\quad\quad}$      $5 \times 4 = \underline{\quad\quad}$

multiply by 5 (1–5)

Name \_\_\_\_\_

Date \_\_\_\_\_

1. Cut out all the polygons (M–X) in the Template. Then, use the polygons to complete the following chart.

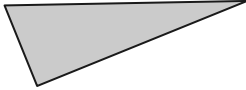
Attribute	List polygons' letters for each group.	Sketch 1 polygon from the group.
<i>Example:</i> <b>3 Sides</b>	Polygons: Y, Z	
<b>All Sides Are Equal</b>	Polygons:	
<b>All Sides Are Not Equal</b>	Polygons:	
<b>At Least 1 Right Angle</b>	Polygons:	
<b>At Least 1 Set of Parallel Sides</b>	Polygons:	

2. Compare Polygon M and Polygon X. What is the same? What is different?
3. Jenny says, “Polygon N, Polygon R, and Polygon S are all regular quadrilaterals!” Is she correct? Why or why not?
4. “I have six equal sides and six equal angles. I have three sets of parallel lines. I have no right angles.”
- Write the letter and the name of the polygon described above.
  - Estimate to draw the same type of polygon as in part (a), but with no equal sides.

Name \_\_\_\_\_

Date \_\_\_\_\_

Jonah draws the polygon below. Use your ruler and right angle tool to measure his polygon. Then, answer the questions below.



1. Is Jonah's polygon a regular polygon? Explain how you know.
2. How many right angles does his polygon have? Circle the right angles on his polygon.
3. How many sets of parallel lines does his polygon have?
4. What is the name of Jonah's polygon?

Name \_\_\_\_\_

Date \_\_\_\_\_

1. Match the polygons with their appropriate clouds. A polygon can match to more than 1 cloud.

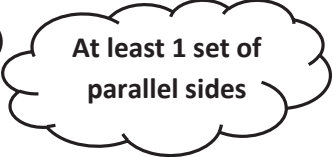
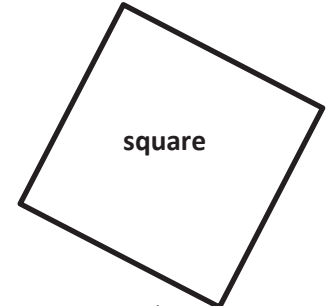
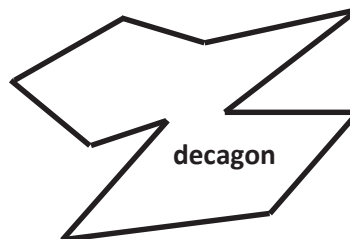
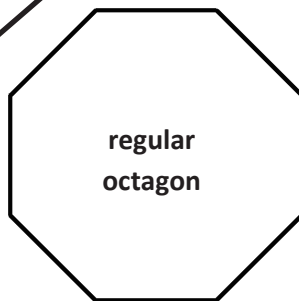
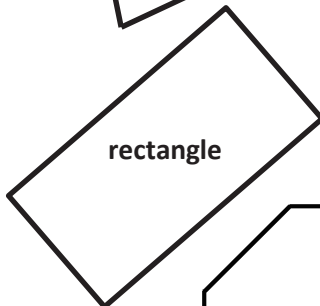
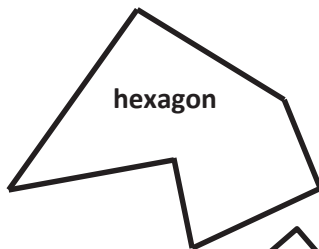
All sides are equal.All sides are not equal.At least 1 right angleAt least 1 set of parallel sides

2. The two polygons below are regular polygons. How are these polygons the same? How are they different?

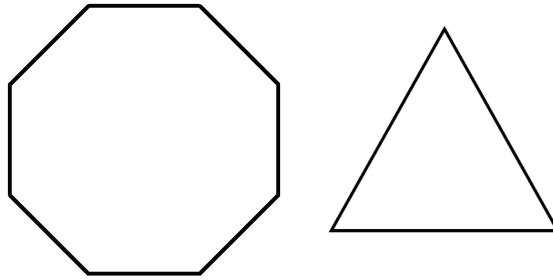

3. Lucia drew the polygons below. Are any of the polygons she drew regular polygons? Explain how you know.

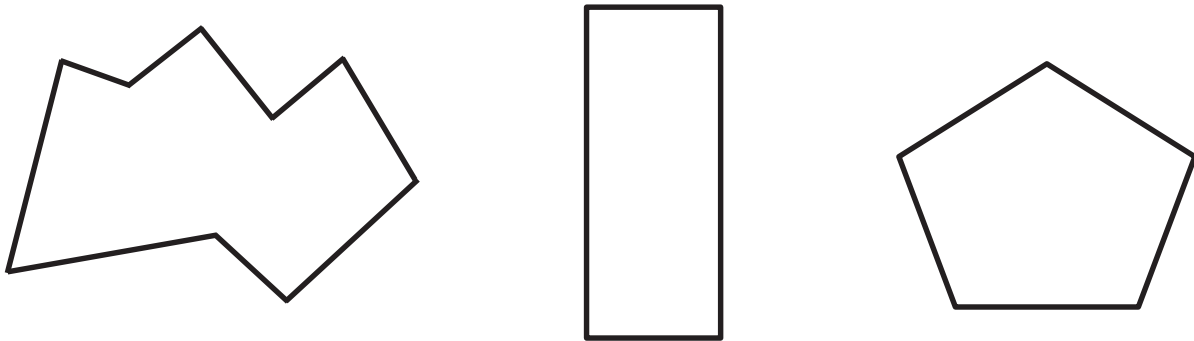



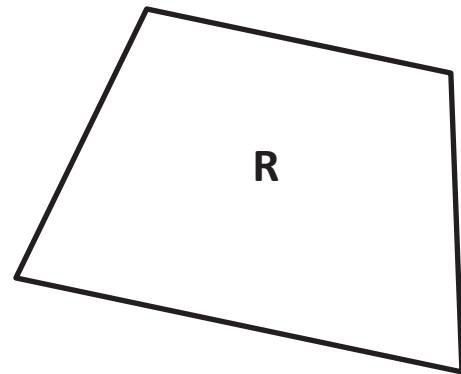
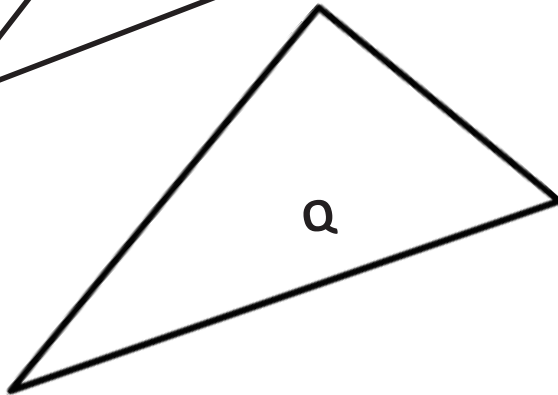
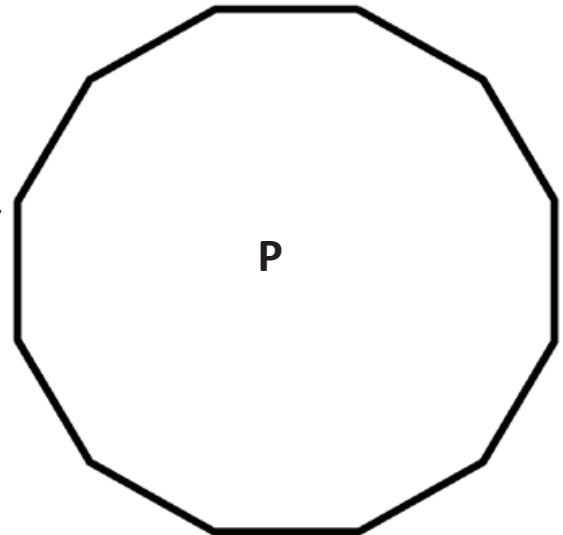
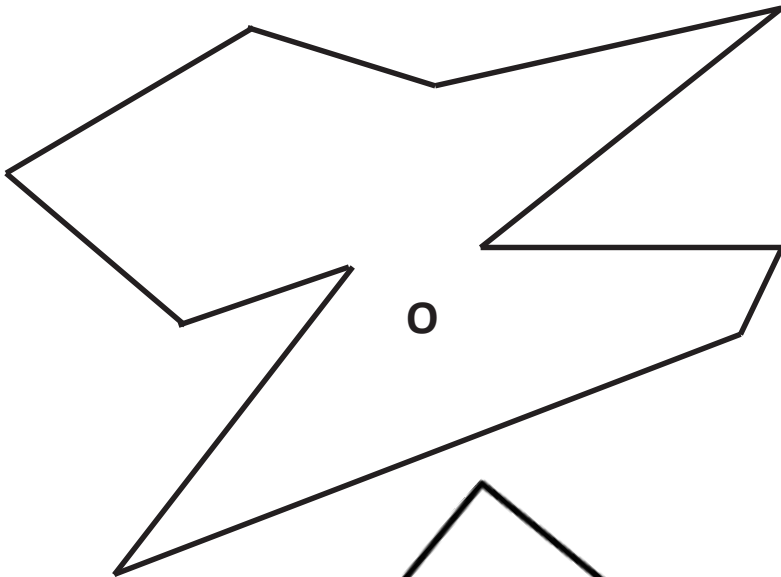
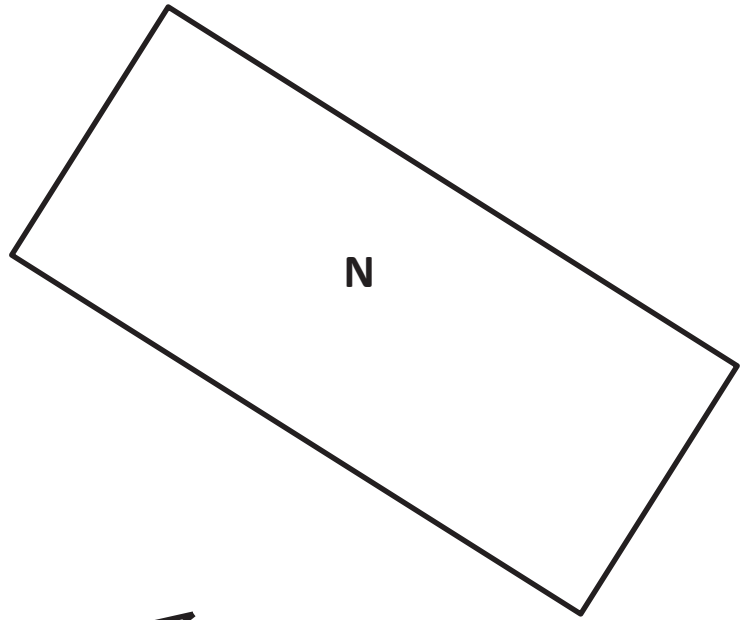
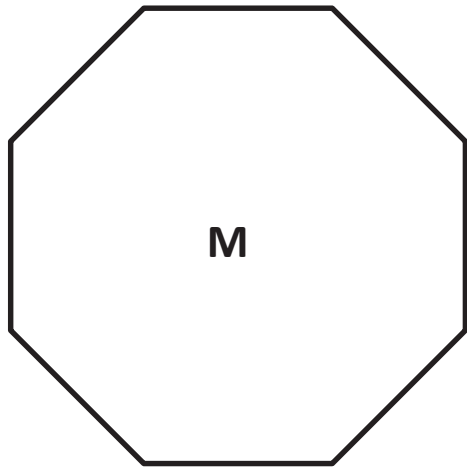

---

polygons (M–X)

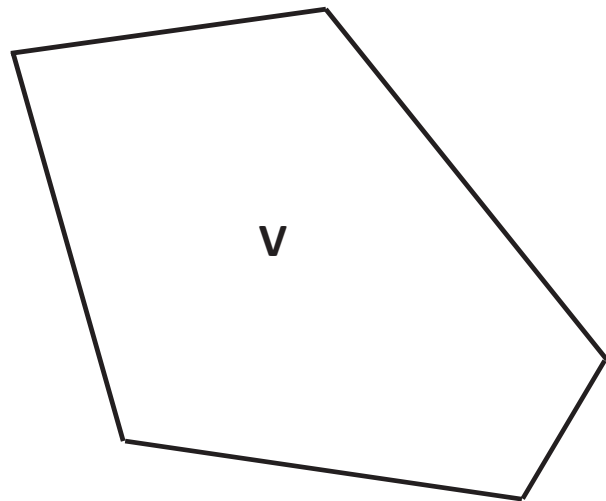
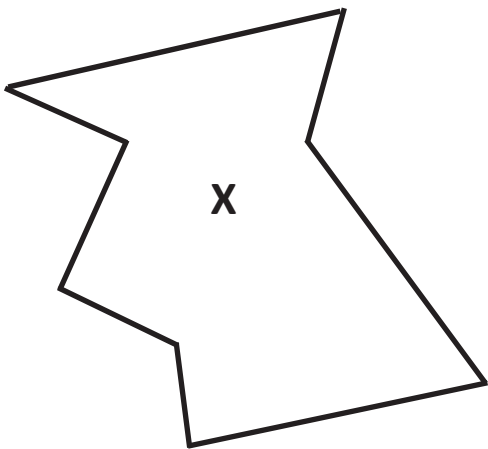
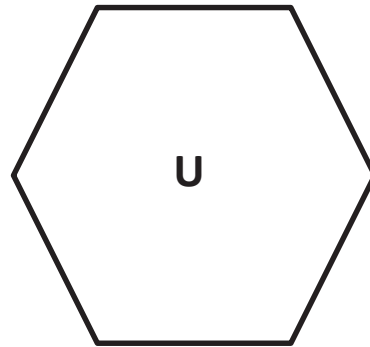
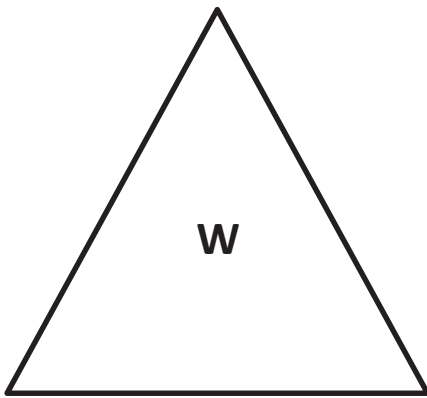
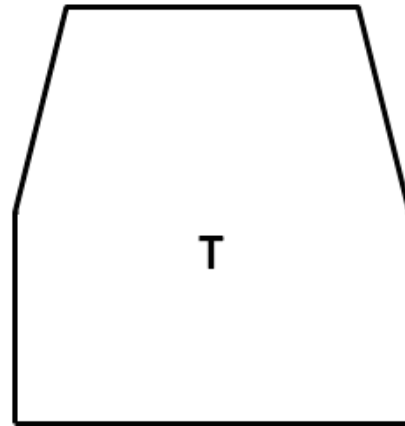
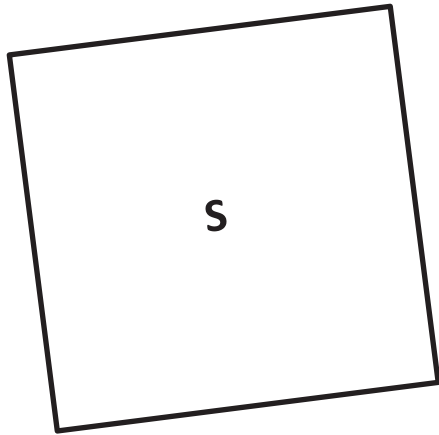

---

polygons (M–X)

## Lesson 6

Objective: Draw polygons with specified attributes to solve problems.

### Suggested Lesson Structure

■ Fluency Practice	(12 minutes)
■ Application Problem	(8 minutes)
■ Concept Development	(30 minutes)
■ Student Debrief	(10 minutes)
<b>Total Time</b>	<b>(60 minutes)</b>

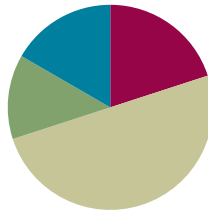

### Fluency Practice (12 minutes)

- Equivalent Counting with Units of 7 **3.OA.7** (4 minutes)
- Classify the Polygon **3.G.1** (5 minutes)
- Physiometry **3.G.1** (3 minutes)

### Equivalent Counting with Units of 7 (4 minutes)

Note: This activity builds fluency with multiplication facts using units of 7. The progression builds in complexity. Work students up to the highest level of complexity where they can confidently participate.

T: Count to 10. (Write as students count. See the chart below.)

S: 1, 2, 3, 4, 5, 6, 7, 8, 9, 10.

1	2	3	4	5	6	7	8	9	10
1 seven	2 sevens	3 sevens	4 sevens	5 sevens	6 sevens	7 sevens	8 sevens	9 sevens	10 sevens
7	14	21	28	35	42	49	56	63	70
1 seven	14	3 sevens	28	5 sevens	42	7 sevens	56	9 sevens	70
7	2 sevens	21	4 sevens	35	6 sevens	49	8 sevens	63	10 sevens

T: (Write 1 seven beneath the 1.) Count to 10 sevens. (Write as students count.)

S: 1 seven, 2 sevens, 3 sevens, 4 sevens, 5 sevens, 6 sevens, 7 sevens, 8 sevens, 9 sevens, 10 sevens.

T: Count by sevens to 70. (Write as students count.)

S: 7, 14, 21, 28, 35, 42, 49, 56, 63, 70.

- T: (Write 1 seven beneath the 7. Write 14 beneath the 14.) I'm going to give you a challenge. Let's alternate between saying the units of seven and the number. (Write as students count.)
- S: 1 seven, 14, 3 sevens, 28, 5 sevens, 42, 7 sevens, 56, 9 sevens, 70.
- T: (Write 7 beneath 1 seven and 2 sevens beneath the 14.) Let's alternate again. (Write as students count.)
- S: 7, 2 sevens, 21, 4 sevens, 35, 6 sevens, 49, 8 sevens, 63, 10 sevens.

### Classify the Polygon (5 minutes)

Materials: (S) Personal white board

Repeat Classify the Polygon from Lesson 5 using different shapes or orienting the same shapes differently.

Note: This activity reviews identifying attributes and naming shapes.

### Physiometry (3 minutes)

Note: Kinesthetic memory is strong memory. This activity reviews vocabulary from Lessons 4 and 5.

- T: Stand up. (After students stand, stretch one arm up directly toward the ceiling. Stretch the other arm toward a wall, parallel to the floor.) What type of angle am I modeling with my arms?
- S: A right angle.
- T: Model a right angle with your arms.
- S: (Mirror the teacher.)
- T: (Stretch the arm pointing toward a wall directly up toward the ceiling. Move the arm pointing toward the ceiling so that it points directly toward the opposite wall.) Model another right angle.
- S: (Mirror the teacher.)
- T: How many sides does a triangle have?
- S: Three sides.
- T: Using your arms, model a triangle with the person standing next to you.
- S: (Connect arms with partner to model a three-sided figure.)
- T: What do we call a four-sided figure?
- S: Quadrilateral.
- T: Use your body to make a quadrilateral with your partner.
- S: (Model a four-sided figure with partner.)



#### NOTES ON MULTIPLE MEANS OF REPRESENTATION:

If necessary, adjust questions for Classify the Polygon for English language learners and others who may not easily name shapes. Instead of asking, "What are shapes that have four sides called?" ask, "This is a trapezoid. Say 'trapezoid.' How many sides does a trapezoid have?"

### Application Problem (8 minutes)

Frankie says that all squares are rectangles, but not all rectangles are squares. Do you agree with this statement? Why or why not? Draw diagrams to support your statement.

Note: This Application Problem engages students in MP.3, constructing viable arguments and critiquing the reasoning of others, while revisiting the classification of squares as being a special type of rectangle.

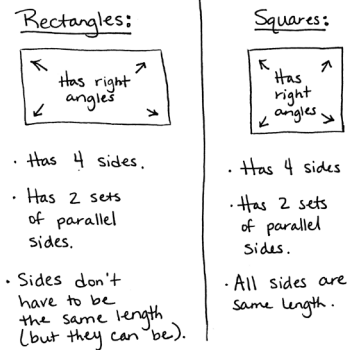

### Concept Development (30 minutes)

Materials: (T) Game cards (Template 2) (S) Personal white board, ruler, right angle tool, math journal, polygon (Template 1) (1 per pair), game cards (Template 2) (1 set per pair, cut out)

Project Template 1 as shown, and give a copy of the shape to each pair of students.

- T: Work with a partner to analyze this shape, and list as many attributes as you can on your personal white board. Use your right angle tools and rulers to help you.
- S: (Work in pairs. Produce these possible responses: quadrilateral, trapezoid, four-sided, one pair of parallel sides, two right angles, two equal sides.)

Build class consensus by inviting different pairs to share attributes. Use a right angle tool to verify the two right angles and a ruler to verify the equal sides. Write the list of attributes on the board as students share. Then, ask students to erase their boards.

- T: We found two angles that are right angles. Let's talk about a way to describe the other angles, too. Now compare this angle with our right angle tool. (Place the right angle tool so that students can see that one angle is greater than a right angle.) Is this angle greater than or less than a right angle? How do you know?
- S: It's greater than a right angle because it's bigger than the right angle tool! → The sides of the angle open wider than the right angle. → The right angle is just a part of the bigger angle.

I agree with Frankie. A square has all the same things as a rectangle. It's a rectangle with 4 equal sides. But rectangles don't always have to have equal sides.

Template 1



#### NOTES ON MULTIPLE MEANS OF ACTION AND EXPRESSION:

Scaffold shape analysis with questions or sentence frames:

- I see \_\_\_\_ angles.
- How many right angles do you count?
- How many equal sides do you measure?
- This shape is called a \_\_\_\_.
- How many sets of parallel sides do you see?

- T: Some angles are *greater than a right angle*. Let's add *1 angle greater than a right angle* to our list of attributes for this shape. (Place right angle tool so that students can see that 1 angle is less than a right angle.) What about this angle?
- S: It's less than a right angle. → I can see that because it's smaller than the right angle tool.
- T: True. Some angles are *less than a right angle*. Let's add *1 angle less than a right angle* to our list of attributes for this shape.
- T: (Circle *1 angle greater than a right angle* on the list of attributes on the board.) Draw a shape with one angle that is greater than a right angle.
- S: (Draw. There are a variety of possibilities.)
- T: (Compare a few different shapes, and ask the class to confirm their validity. Circle *2 right angles* on the list of attributes.) Talk to a partner: What tool or tools will you use to draw a different shape that has at least two right angles?
- S: My right angle tool! → I think I'll use my ruler, too. → The right angle tool will help me make sure I have at least two right angles, and my ruler will help me draw straight lines.
- T: I agree! Use your ruler and right angle tool to draw a different shape that has at least two right angles.
- S: (Draw. There are a variety of possibilities.)
- T: (Circulate to see that students have drawn shapes that have at least two right angles, and then have students erase their boards. Circle *quadrilateral*, *2 equal sides*, and *1 pair of parallel sides*.) Talk to a partner: What tool or tools will you use to draw a shape with the circled attributes?
- S: A ruler. → I'll use my ruler to make sure I have two equal sides. → My ruler will also help me draw straight lines. → Since I don't have to worry about drawing any right angles, I can just use my ruler to measure the side lengths and draw straight lines.
- T: Use your ruler to draw a shape with the circled attributes. Label the equal side lengths.

Continue as necessary.

- T: Work with a partner to figure out whether or not you can draw a quadrilateral with more than four angles. (Allow students time to work.) What do you think?
- S: No. You can't. Every time we made an extra angle, it made an extra side, too! → In the shapes we drew, the number of sides matched the number of angles. To get more than four angles, you need more than four sides, and then the shape isn't a quadrilateral anymore!



### NOTES ON MULTIPLE MEANS OF ENGAGEMENT:

If appropriate for the class, continue to use the written list with the attributes discussed at the beginning of the lesson to support students with drawing until they are ready to move on.

MP.5

T: True. Let's play a game! (Hold up Template 2.) These are the directions:

- Place the cards facedown.
- Pick one card from each letter, A, B, and C.
- Flip over the cards you chose. Record the game card descriptions in your journal.
- Use the appropriate tools to draw the shape in your math journal. If the shape is not possible, list reasons in your math journal why it is not.

T: Ready? (Draw three cards, and read or project the cards. *Is a quadrilateral, has all equal sides, and has at least 1 right angle* are the cards used in the example that follows.)

S: This one is easy! I can just draw a square! (Record descriptions, and draw the shape.)

T: At the signal, show your drawing. (Signal. Validate shapes, and repeat the process. The cards *has no parallel sides, has more than 4 angles, and is a parallelogram* are used in the example that follows.)

S: Wait! I can't draw this shape! (Note descriptions and reasons in math journals.)

T: Tell your partner why this shape can't be drawn.

S: Because a parallelogram has to have two sets of parallel sides! It can't have *no* parallel sides!

Repeat the process. As students are ready, have them work independently, in pairs, or in small groups to play the game on their own. Have them play two or three rounds on their own.

### Problem Set (10 minutes)

Students should do their personal best to complete the Problem Set within the allotted 10 minutes. For some classes, it may be appropriate to modify the assignment by specifying which problems they work on first. Some problems do not specify a method for solving. Students should solve these problems using the RDW approach used for Application Problems.

### Student Debrief (10 minutes)

**Lesson Objective:** Draw polygons with specified attributes to solve problems.

The Student Debrief is intended to invite reflection and active processing of the total lesson experience.

Invite students to review their solutions for the Problem Set. They should check work by comparing answers with a partner before going over answers as a class. Look for misconceptions or misunderstandings that can be addressed in the Debrief. Guide students in a conversation to debrief the Problem Set and process the lesson.

Template 2 Front

has at least 1 angle <b>greater than</b> a right angle	is a quadrilateral	has all equal sides (label side lengths)
has at least 1 angle <b>less than</b> a right angle	is a trapezoid	has at least 2 equal sides (label side lengths)
has at least 1 right angle	is a hexagon	has at least 1 set of parallel sides
has more than 4 angles	is a parallelogram	has no parallel sides

Template 2 Back

A	B	C
A	B	C
A	B	C
A	B	C

Any combination of the questions below may be used to lead the discussion.

- Besides *quadrilateral*, what is another name for the shape you drew for Problem 3? (Possible answers are *trapezoid*, *parallelogram*, *rectangle*, *square*, and *rhombus*.) How can it be that so many names describe our shape?
- Which shape was most difficult to draw precisely? Why?
- Ask students to share their ideas about Problem 6. How did our work in today's lesson prepare you to answer that question?
- Invite students to share some of the combinations that they drew or could not draw during the game. Why couldn't you draw some of the combinations? For which combinations could you draw more than one shape?
- How did today's Fluency Practice connect to the lesson?

### Exit Ticket (3 minutes)

After the Student Debrief, instruct students to complete the Exit Ticket. A review of their work will help with assessing students' understanding of the concepts that were presented in today's lesson and planning more effectively for future lessons. The questions may be read aloud to the students.

Name Gina Date \_\_\_\_\_

Use a ruler and a right angle tool to help you draw the figures with the given attributes below.

1. Draw a triangle with 1 right angle.

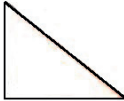

2. Draw a quadrilateral with 4 right angles and sides that are all 2 inches long.

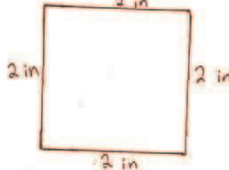

3. Draw a quadrilateral with at least 1 set of parallel sides. Trace the parallel sides green.



4. Draw a pentagon with at least 2 equal sides. Label the 2 equal side lengths of your shape.

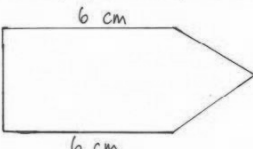

5. Draw a hexagon with at least 2 equal sides. Label the 2 equal side lengths of your shape.

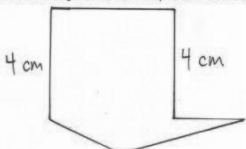

6. Sam says that he drew a polygon with 2 sides and 2 angles. Can Sam be correct? Use pictures to help you explain your answer.

D

^

||

Sam can't be correct because you can't have 2 straight sides and 2 angles. To get 2 angles, I had to draw a curved line. Maybe he means 3 straight sides and 3 angles, because a polygon needs 3 straight sides and 3 angles.



Name \_\_\_\_\_

Date \_\_\_\_\_

Use a ruler and a right angle tool to help you draw the figures with the attributes given below.

1. Draw a triangle with 1 right angle.

2. Draw a quadrilateral with 4 right angles and sides that are all 2 inches long.

3. Draw a quadrilateral with at least 1 set of parallel sides. Trace the parallel sides green.

4. Draw a pentagon with at least 2 equal sides. Label the 2 equal side lengths of your shape.

5. Draw a hexagon with at least 2 equal sides. Label the 2 equal side lengths of your shape.

6. Sam says that he drew a polygon with 2 sides and 2 angles. Can Sam be correct? Use pictures to help you explain your answer.

Name \_\_\_\_\_

Date \_\_\_\_\_

Use a ruler and a right angle tool to help you draw a shape that matches the attributes of Jeanette's shape. Label your drawing to explain your thinking.

Jeanette says her shape has 4 right angles and 2 sets of parallel sides. It is not a regular quadrilateral.

Name \_\_\_\_\_

Date \_\_\_\_\_

Use a ruler and a right angle tool to help you draw the figures with the given attributes below.

1. Draw a triangle that has no right angles.

2. Draw a quadrilateral that has at least 2 right angles.

3. Draw a quadrilateral with 2 equal sides. Label the 2 equal side lengths of your shape.

4. Draw a hexagon with at least 2 equal sides. Label the 2 equal side lengths of your shape.
5. Draw a pentagon with at least 2 equal sides. Label the 2 equal side lengths of your shape.
6. Cristina describes her shape. She says it has 3 equal sides that are each 4 centimeters in length. It has no right angles. Do your best to draw Cristina’s shape, and label the side lengths.

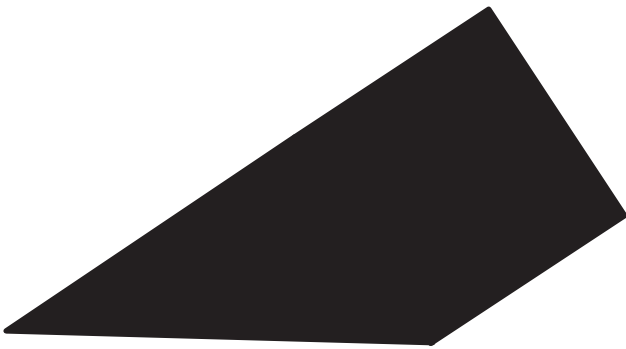
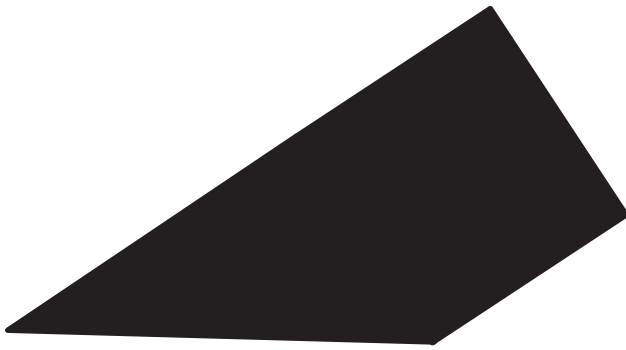

---

\_\_\_\_\_

polygon

has at least 1 angle <b>greater than</b> a right angle	is a quadrilateral	has all equal sides (label side lengths)
has at least 1 angle <b>less than</b> a right angle	is a trapezoid	has at least 2 equal sides (label side lengths)
has at least 1 right angle	is a hexagon	has at least 1 set of parallel sides
has more than 4 angles	is a parallelogram	has no parallel sides

---

game cards

A	B	C
A	B	C
A	B	C
A	B	C

---

game cards



## Lesson 7

**Objective:** Reason about composing and decomposing polygons using tetrominoes.

### Suggested Lesson Structure

■ Fluency Practice	(15 minutes)
■ Concept Development	(35 minutes)
■ Student Debrief	(10 minutes)
<b>Total Time</b>	<b>(60 minutes)</b>

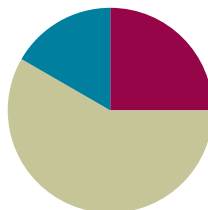

### Fluency Practice (15 minutes)

- Multiply by 5 **3.OA.7** (8 minutes)
- Physiometry **3.G.1** (3 minutes)
- Classify the Shape **3.G.1** (4 minutes)

### Multiply by 5 (8 minutes)

Materials: (S) Multiply by 5 (6–10) Pattern Sheet

Note: This activity builds fluency with multiplication facts using units of 5. It works toward students knowing from memory all products of two one-digit numbers. See Lesson 1 for directions for administration of a Multiply-By Pattern Sheet.

T: (Write  $7 \times 5 = \underline{\quad}$ .) Let's skip-count up by fives. I'll raise a finger for each five. (Raise a finger for each number to track the count.)

S: 5, 10, 15, 20, 25, 30, 35.

T: Let's skip-count by fives starting at 25. Why is 25 a good place to start?

S: It's a fact we already know, so we can use it to figure out a fact we don't know.

T: (Track with fingers as students say the numbers.)

S: 25 (5 fingers), 30 (6 fingers), 35 (7 fingers).

T: Let's see how we can skip-count down to find the answer, too. Start at 50 with 10 fingers, 1 for each five. (Count down with fingers as students say the numbers.)

S: 50 (10 fingers), 45 (9 fingers), 40 (8 fingers), 35 (7 fingers).

Continue with the following possible sequence:  $9 \times 5$ ,  $6 \times 5$ , and  $8 \times 5$ .

T: (Distribute the Multiply by 5 Pattern Sheet.) Let's practice multiplying by 5. Be sure to work left to right across the page.

**Physiometry (3 minutes)**

Note: Kinesthetic memory is strong memory. This activity reviews terms from Lessons 4 and 5.

T: Stand up.

S: (Stand up.)

T: (Stretch one arm up, directly toward the ceiling. Stretch the other arm parallel to the floor.) What type of angle do you think I'm modeling with my arms?

S: Right angle.

T: Model a right angle with your arms.

S: (Mirror the teacher.)

T: (Stretch the arm parallel to the floor toward the ceiling. Move the arm pointing toward the ceiling so that it points toward the opposite wall.) Model another right angle.

S: (Mirror the teacher.)

T: How many sides does a triangle have?

S: Three sides.

T: Using your arms, model a triangle with the person standing next to you.

S: (Model a triangle in pairs.)

T: What do we call a four-sided figure?

S: Quadrilateral.

T: Use your body to make a quadrilateral with your partner.

S: (Model a quadrilateral in pairs.)

T: (Point to a side wall.) Point to the wall that runs parallel to the one to which I'm pointing.

S: (Point to the opposite side wall.)

T: (Point to the back wall so students point to the front wall.)

T: (Point to the front wall so students point to the back wall.)

T: Point to the walls that make a right angle with the wall to which I'm pointing.

T: (Point to the back wall so students point to the side walls.)

T: (Point to the side wall so students point to the front and back walls.)

Repeat with the front wall.

**Classify the Shape (4 minutes)**

Materials: (S) Personal white board

Repeat Classify the Polygon from Lesson 5 with different shapes or orienting the same shapes differently.

Note: This activity reviews Lesson 4.

## Concept Development (35 minutes)

Materials: (T) Tetrominoes (Template) (S) Problem Set, tetrominoes (Template), crayons

Note: The Template in this lesson is a full sheet of each of the five types of tetrominoes (shown on the next page). Make copies of each sheet on different color cardstock to color-code the pieces. Then, cut the tetrominoes out, and bag sets that include multiple copies of each tetromino type for student use during the lesson. Enlist the help of volunteers to assist in preparing the tetrominoes for this lesson.

### Problem 1: Use tetrominoes to compose polygons.

T: (Project or hold up the tetrominoes.) Each of these shapes is called a **tetromino**. The area of each tetromino is measured in square units. What is the area of each one in square units?

S: 4 square units.

T: Notice that each square unit shares a whole side with another square. Whisper the name of these shapes to a partner.

S: (Whisper *tetromino* to a partner.)

T: Take a few minutes to make some shapes with the tetrominoes. (Allow students time to explore.) What shapes did you make?

S: (Possible responses include rectangle, square, and hexagon.)

T: Tell your partner how you moved the tetrominoes to make them fit together.

S: I turned some of the pieces. → I rotated them.

T: To make shapes, you'll have to rotate them and sometimes even flip them over. (Demonstrate turning one over so the back is faceup.) Read Problem 1.

S: (Read: *Use tetrominoes to create at least two different rectangles. Then, color the grid below to show how you created your rectangles. You may use the same tetromino more than once.*)

T: Look at the grid in Problem 1. How many squares will you color for each tetromino you use?

S: Four squares!

T: How will someone who looks at your grid be able to tell which tetromino pieces you used to make each rectangle?

S: I can color the grid the same color as the tetromino pieces! → I can color the squares on the grid to look like the shape of each tetromino that I use.

T: Go ahead and use your tetrominoes to answer Problem 1. (Circulate.)



#### NOTES ON MULTIPLE MEANS OF REPRESENTATION:

*Tetromino* is pronounced /tɛ'trɑːmɪnoʊ/. If helpful, explain to English language learners and others that the number prefix *tetra-* brings a meaning of *four*, similar to the number prefix *quadr-*. Relate *tetromino* to familiar words such as the video game *Tetris* and *domino* (having two squares).

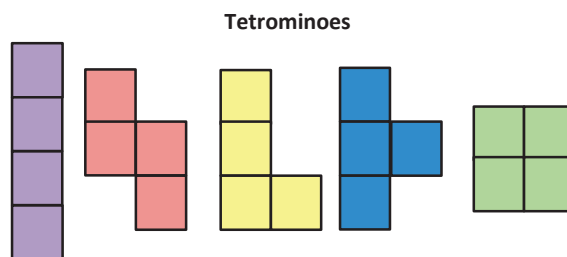

MP.3

- T: Talk to a partner: How do you know the shapes that you made in Problem 1 are rectangles?
- S: They look like rectangles! → I counted the units for the sides of my shapes. The opposite sides are equal. I know rectangles have opposite sides that are equal. → I can use the corner of an index card to make sure my shapes have four right angles. → My shapes have two sets of parallel lines, like a rectangle. → Opposite sides that are equal, four right angles, and two sets of parallel lines are attributes of rectangles. My shapes have all of these attributes, so my shapes are rectangles!
- T: Talk to a partner: What is the smallest rectangle you can make with tetrominoes? How do you know?
- S: A 1 unit by 4 unit rectangle. → The long, straight tetromino is already a rectangle, and its area is 4 square units. → Or we could make a 2 unit by 2 unit rectangle with the square piece. → The square is a rectangle, too, and its area is 4 square units!
- T: Work with a partner to make the smallest rectangle you can without using the square or long, straight tetromino. (Allow students time to work.) How did you make your rectangle?
- S: We made a 3 unit by 4 unit rectangle with two T-shaped tetrominoes and one L-shaped tetromino. → We made the same size rectangle, but we used two L-shaped tetrominoes and one Z-shaped tetromino. → I think our rectangle is the smallest because we made a 2 by 4 rectangle using two L-shaped tetrominoes.

**Problem 2: Use tetrominoes to compose polygons with given areas.**

- T: Read Problem 2.
- S: (Read: *Use tetrominoes to create at least two squares, each with an area of 36 square units. Then, color the grid below to show how you created your squares. You may use the same tetromino more than once.*)
- Write a number sentence to show the area of a square above as the sum of the areas of the tetrominoes you used to make the square.
  - Write a number sentence to show the area of a square above as the product of its side lengths.)

- T: How is Problem 2 different from Problem 1?
- S: It tells us the area of the square has to be 36 square units.
- T: Talk to your partner: How many tetrominoes will you use to solve Problem 2? How do you know?
- S: Enough to fill 36 square units. → Nine tetrominoes because each tetromino has an area of 4 square units, and  $9 \times 4 = 36$ . → I can also divide to figure it out, like this:  $36 \div 4 = 9$ .
- T: What will be the side lengths of your square? How do you know?
- S: 6 units because the side lengths of a square are equal.
- T: Talk to a partner: How can the grid help you make a square with an area of 36 square units?
- S: I can mark a 6 by 6 square on the grid so that I know my square has the right area. → Then, I can just color the grid—I don't even need to use the tetrominoes. → I think after I colored the grid, I would build the square with the tetrominoes, just to be sure!



**NOTE ON  
MULTIPLE MEANS  
OF ENGAGEMENT:**

Part of the excitement of having to find two combinations that make a square is that once the first square comes together, students are excited to see what other pieces they can use to make the second square. To vary the level of challenge, limit which pieces or how many they can use.

T: If that works for you, then use that strategy. Or you can use the strategy you used with the rectangles and build with the tetrominoes first and then color the grid.

Have students solve all of Problem 2. When students are done, facilitate a discussion using the following suggested questions.

- How do you know your shape is a square?
- What is the smallest square you can make with tetrominoes?
- What is the smallest square you can make without using the square tetromino?
- Can you make a square with tetrominoes that has an area of 25 square units? Why or why not?

### Problem Set (10 minutes)

Students should do their personal best to complete the Problem Set within the allotted 10 minutes. For some classes, it may be appropriate to modify the assignment by specifying which problems they work on first. Some problems do not specify a method for solving. Students should solve these problems using the RDW approach used for Application Problems.

### Student Debrief (10 minutes)

**Lesson Objective:** Reason about composing and decomposing polygons using tetrominoes.

The Student Debrief is intended to invite reflection and active processing of the total lesson experience.

Invite students to review their solutions for the Problem Set. They should check work by comparing answers with a partner before going over answers as a class. Look for misconceptions or misunderstandings that can be addressed in the Debrief. Guide students in a conversation to debrief the Problem Set and process the lesson.

Any combination of the questions below may be used to lead the discussion.

- Compare the rectangles you made in Problem 1 to a partner's. How are they the same? How are they different?
- Compare the squares you made in Problem 2 to a partner's. How are they the same? How are they different?
- Say the addition equation in Problem 2(a) as a multiplication equation. Explain to a partner what the factors in the multiplication equation represent.
- Invite students to share how they justified their solution to Problem 3(a).

Name Gina Date \_\_\_\_\_

1. Use tetrominoes to create at least two different rectangles. Then, color the grid below to show how you created your rectangles. You may use the same tetromino more than once.

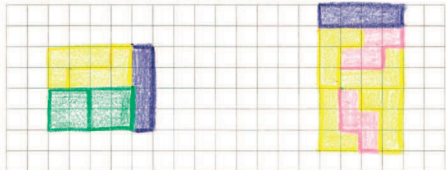

2. Use tetrominoes to create at least two squares, each with an area of 36 square units. Then, color the grid below to show how you created your squares. You may use the same tetromino more than once.

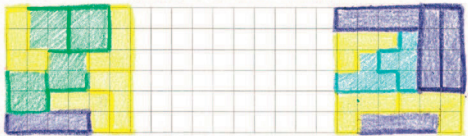

a. Write an equation to show the area of a square above as the sum of the areas of the tetrominoes you used to make the square.

$$4 + 4 + 4 + 4 + 4 + 4 + 4 + 4 + 4 = 36$$

b. Write an equation to show the area of a square above as the product of its side lengths.

$$6 \times 6 = 36$$

- Share solutions to Problem 4.
- What are two attributes of tetrominoes?

### Exit Ticket (3 minutes)

After the Student Debrief, instruct students to complete the Exit Ticket. A review of their work will help with assessing students' understanding of the concepts that were presented in today's lesson and planning more effectively for future lessons. The questions may be read aloud to the students.

3. a. Use tetrominoes to create at least two different rectangles, each with an area of 12 square units. Then, color the grid below to show how you created the rectangles. You may use the same tetromino more than once.

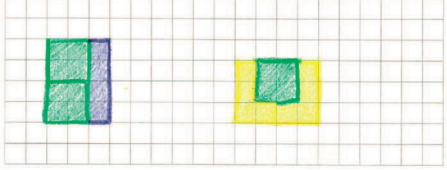

b. Explain how you know the area of each rectangle is 12 square units.

I know the area of each rectangle is 12 square units because I used 3 tetrominoes to make each rectangle. Each tetromino has an area of 4 square units, and  $4 \text{ square units} + 4 \text{ square units} = 12 \text{ square units}$ .

4. Marco created a rectangle with tetrominoes and traced its outline in the space below. Use tetrominoes to recreate it. Estimate to draw lines inside the rectangle below to show how you recreated Marco's rectangle.



Multiply.

$5 \times 1 = \underline{\quad}$      $5 \times 2 = \underline{\quad}$      $5 \times 3 = \underline{\quad}$      $5 \times 4 = \underline{\quad}$

$5 \times 5 = \underline{\quad}$      $5 \times 6 = \underline{\quad}$      $5 \times 7 = \underline{\quad}$      $5 \times 8 = \underline{\quad}$

$5 \times 9 = \underline{\quad}$      $5 \times 10 = \underline{\quad}$      $5 \times 5 = \underline{\quad}$      $5 \times 6 = \underline{\quad}$

$5 \times 5 = \underline{\quad}$      $5 \times 7 = \underline{\quad}$      $5 \times 5 = \underline{\quad}$      $5 \times 8 = \underline{\quad}$

$5 \times 5 = \underline{\quad}$      $5 \times 9 = \underline{\quad}$      $5 \times 5 = \underline{\quad}$      $5 \times 10 = \underline{\quad}$

$5 \times 6 = \underline{\quad}$      $5 \times 5 = \underline{\quad}$      $5 \times 6 = \underline{\quad}$      $5 \times 7 = \underline{\quad}$

$5 \times 6 = \underline{\quad}$      $5 \times 8 = \underline{\quad}$      $5 \times 6 = \underline{\quad}$      $5 \times 9 = \underline{\quad}$

$5 \times 6 = \underline{\quad}$      $5 \times 7 = \underline{\quad}$      $5 \times 6 = \underline{\quad}$      $5 \times 7 = \underline{\quad}$

$5 \times 8 = \underline{\quad}$      $5 \times 7 = \underline{\quad}$      $5 \times 9 = \underline{\quad}$      $5 \times 7 = \underline{\quad}$

$5 \times 8 = \underline{\quad}$      $5 \times 6 = \underline{\quad}$      $5 \times 8 = \underline{\quad}$      $5 \times 7 = \underline{\quad}$

$5 \times 8 = \underline{\quad}$      $5 \times 9 = \underline{\quad}$      $5 \times 9 = \underline{\quad}$      $5 \times 6 = \underline{\quad}$

$5 \times 9 = \underline{\quad}$      $5 \times 7 = \underline{\quad}$      $5 \times 9 = \underline{\quad}$      $5 \times 8 = \underline{\quad}$

$5 \times 9 = \underline{\quad}$      $5 \times 8 = \underline{\quad}$      $5 \times 6 = \underline{\quad}$      $5 \times 9 = \underline{\quad}$

$5 \times 7 = \underline{\quad}$      $5 \times 9 = \underline{\quad}$      $5 \times 6 = \underline{\quad}$      $5 \times 8 = \underline{\quad}$

$5 \times 9 = \underline{\quad}$      $5 \times 7 = \underline{\quad}$      $5 \times 6 = \underline{\quad}$      $5 \times 8 = \underline{\quad}$

multiply by 5 (6–10)

Name \_\_\_\_\_

Date \_\_\_\_\_

1. Use tetrominoes to create at least two different rectangles. Then, color the grid below to show how you created your rectangles. You may use the same tetromino more than once.

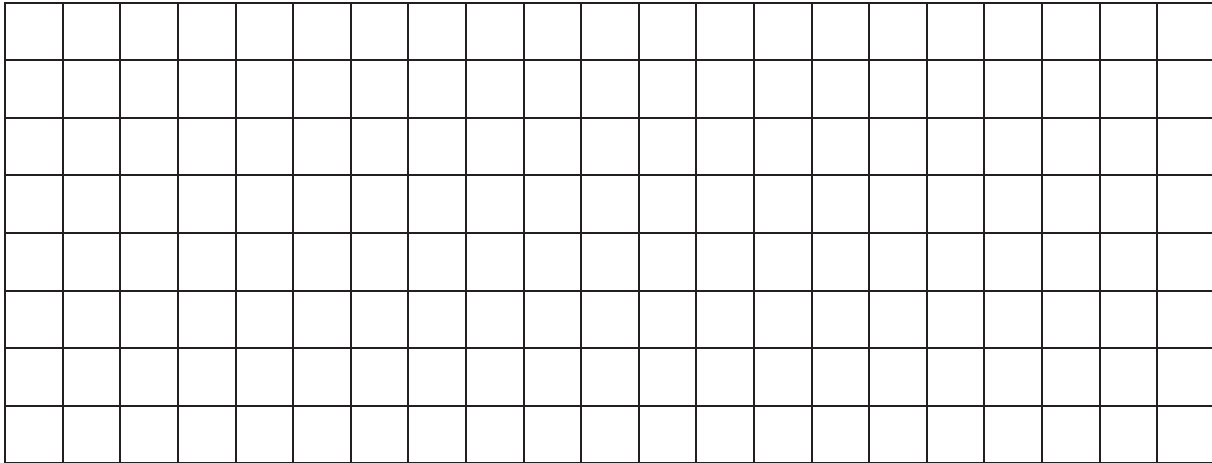

2. Use tetrominoes to create at least two squares, each with an area of 36 square units. Then, color the grid below to show how you created your squares. You may use the same tetromino more than once.

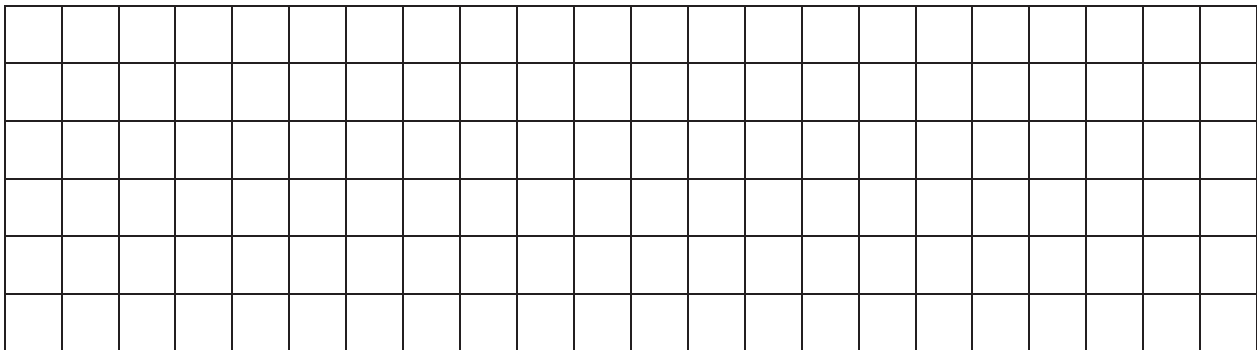

- a. Write an equation to show the area of a square above as the sum of the areas of the tetrominoes you used to make the square.
  
  
  
  
  
  
  
  
  
  
- b. Write an equation to show the area of a square above as the product of its side lengths.



3. a. Use tetrominoes to create at least two different rectangles, each with an area of 12 square units. Then, color the grid below to show how you created the rectangles. You may use the same tetromino more than once.

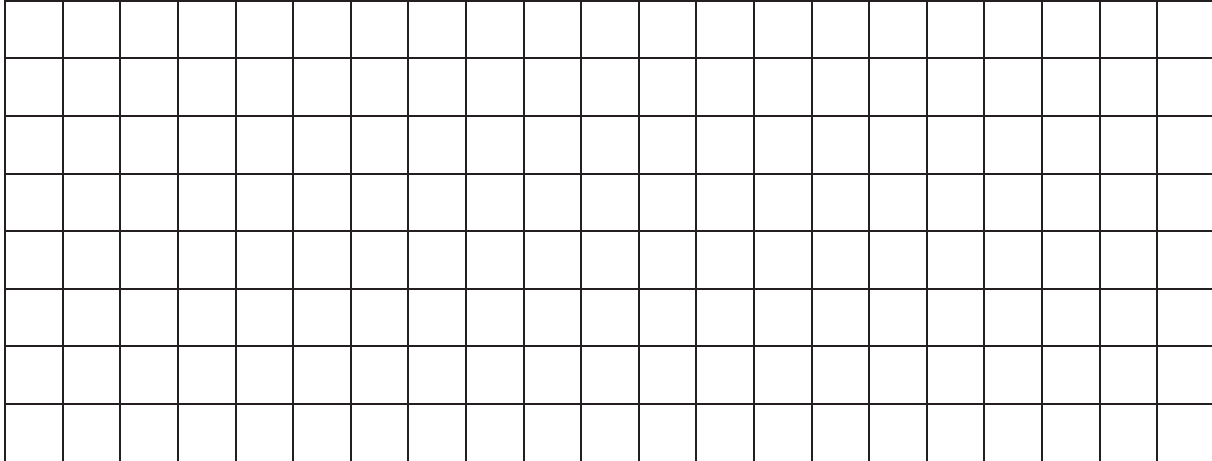

- b. Explain how you know the area of each rectangle is 12 square units.

4. Marco created a rectangle with tetrominoes and traced its outline in the space below. Use tetrominoes to re-create it. Estimate to draw lines inside the rectangle below to show how you re-created Marco's rectangle.



Name \_\_\_\_\_

Date \_\_\_\_\_

Use your tetrominoes to make a rectangle that has an area of 20 square units. Then, color the grid to show how you made your rectangle. You may use the same tetromino more than once.

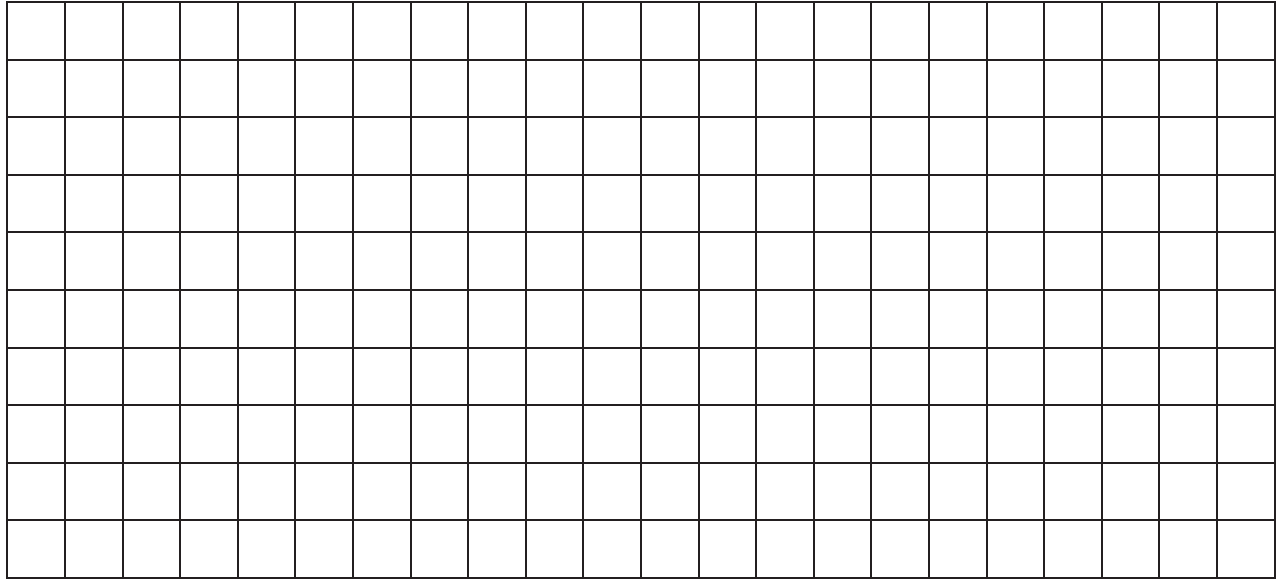

Name \_\_\_\_\_

Date \_\_\_\_\_

- Color tetrominoes on the grid to create three different rectangles. You may use the same tetromino more than once.

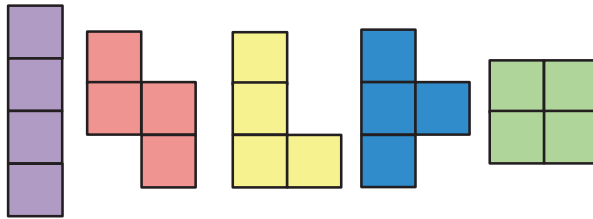

**Tetrominoes**

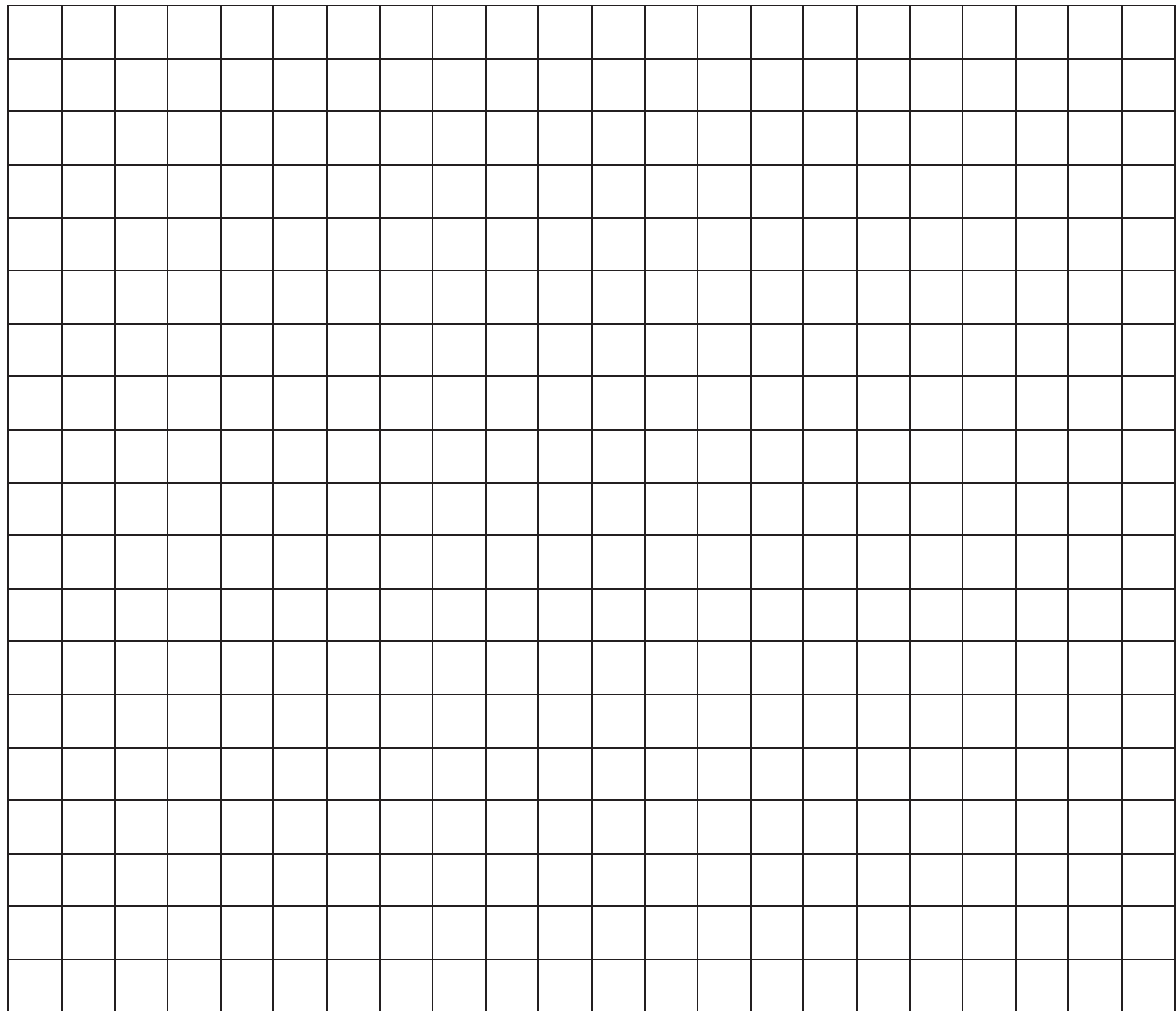

2. Color tetrominoes on the grid below to:

- a. Create a square with an area of 16 square units.
- b. Create at least two different rectangles, each with an area of 24 square units.

You may use the same tetromino more than once.

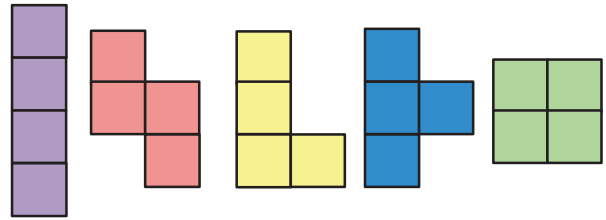

Tetrominoes

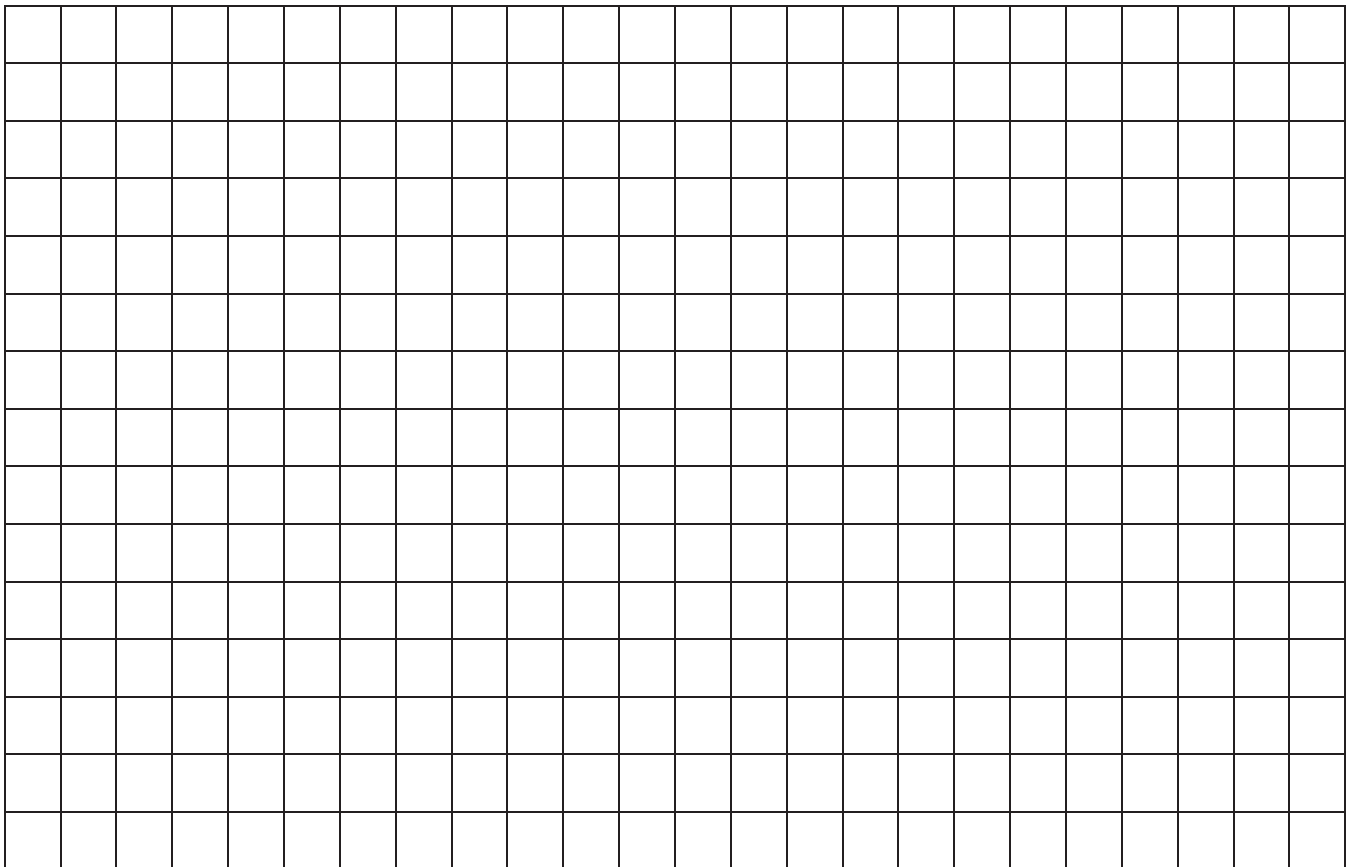

3. Explain how you know the rectangles you created in Problem 2(b) have the correct area.

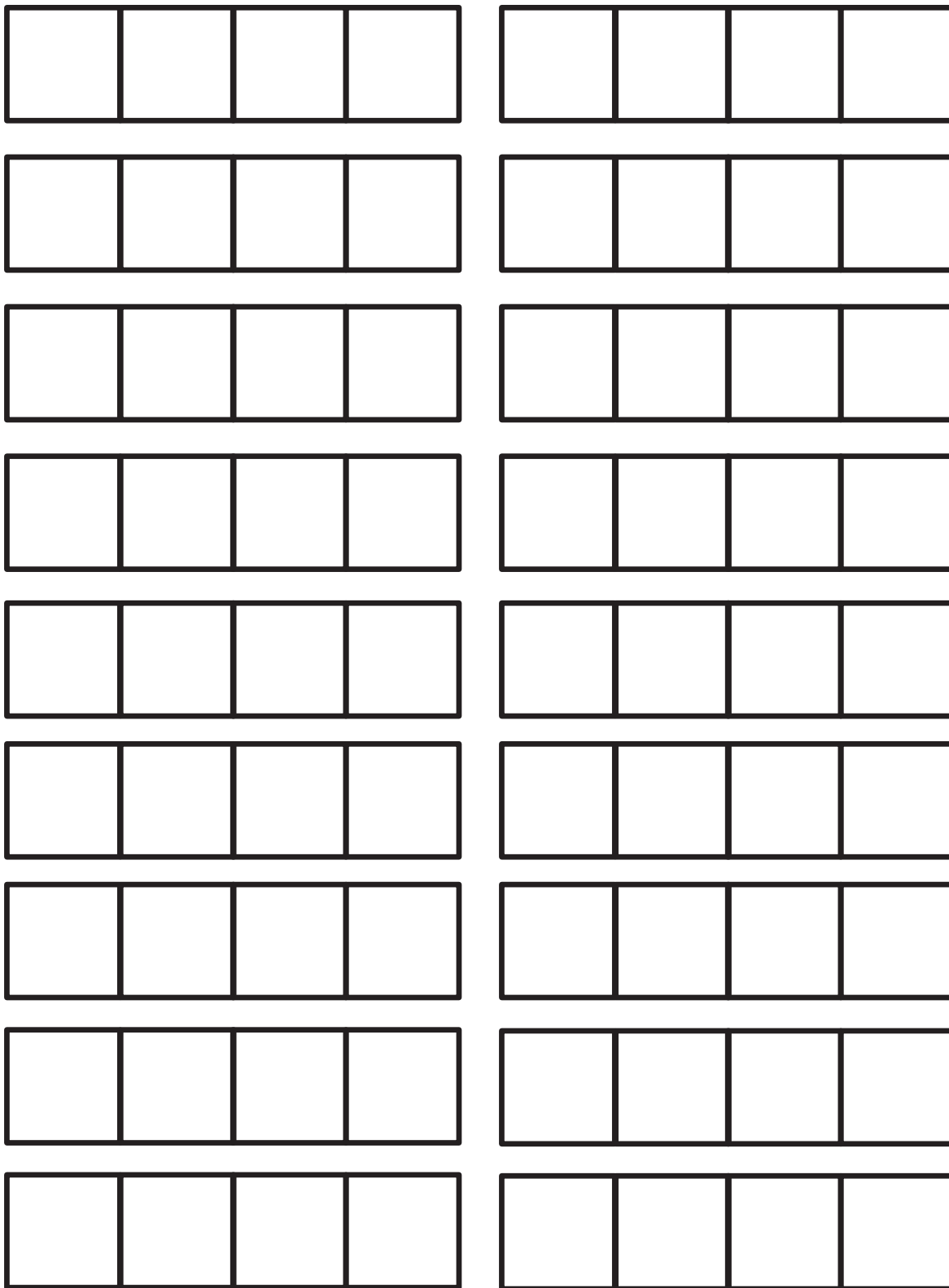

tetrominoes

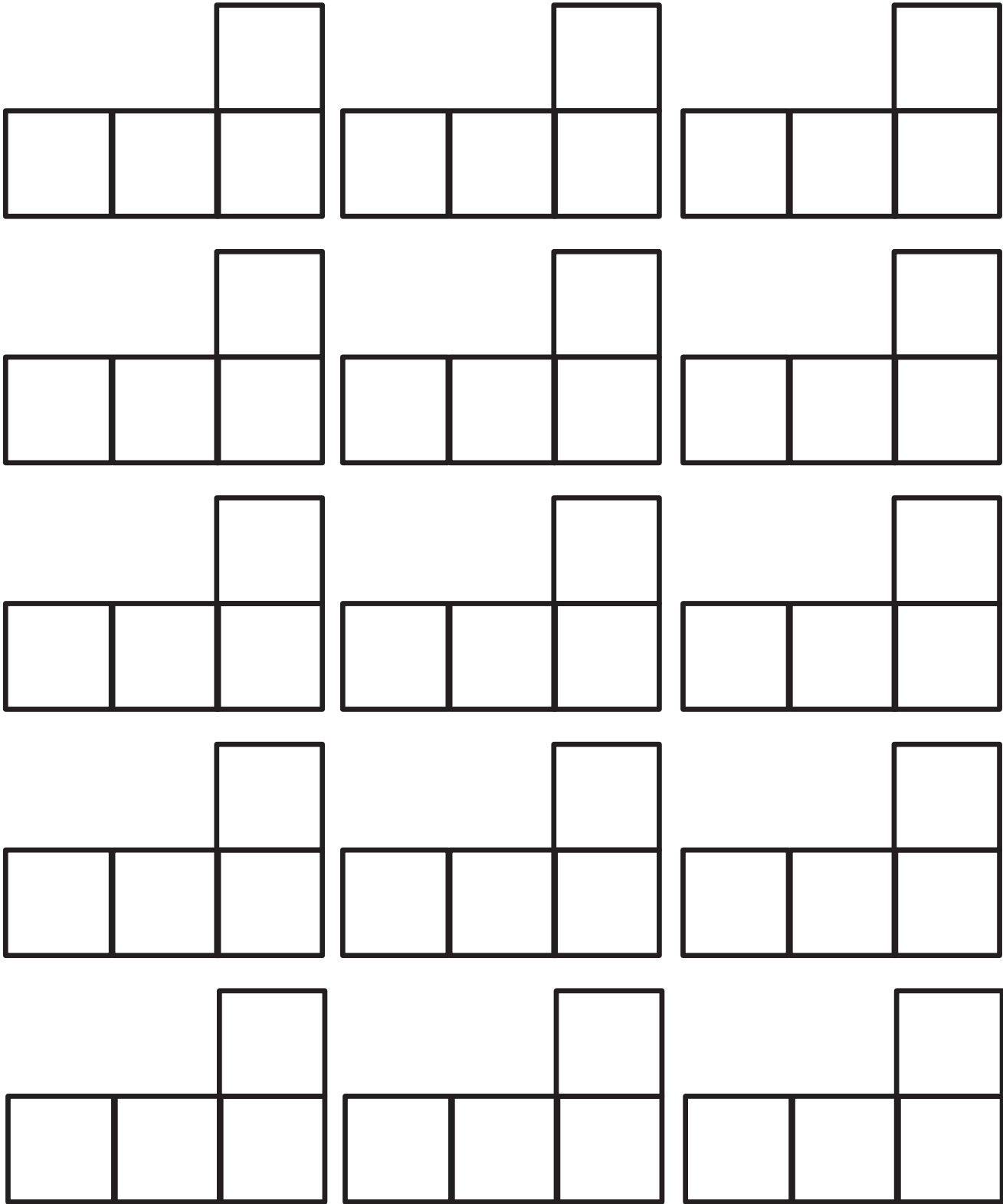

---

tetrominoes

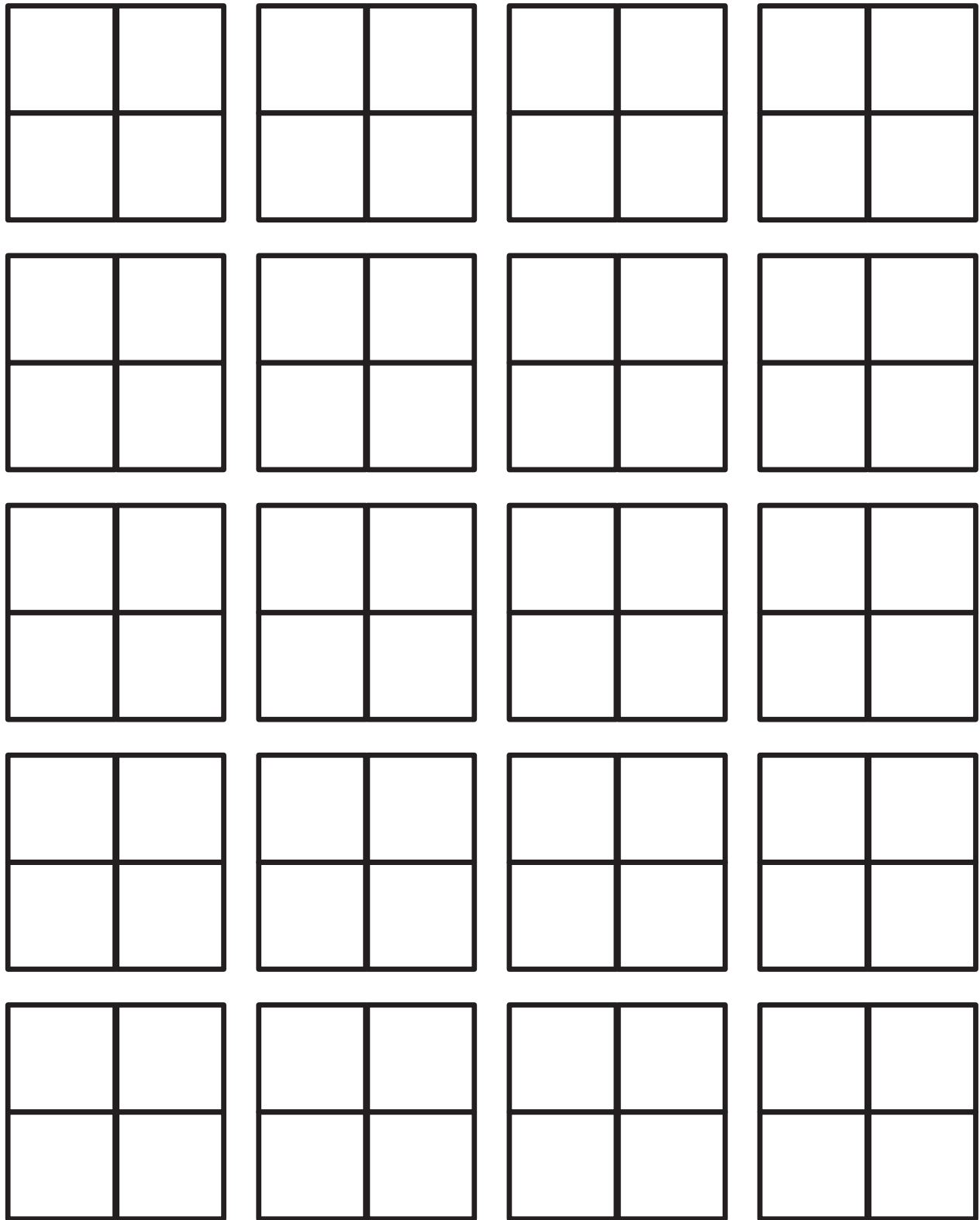

tetrominoes

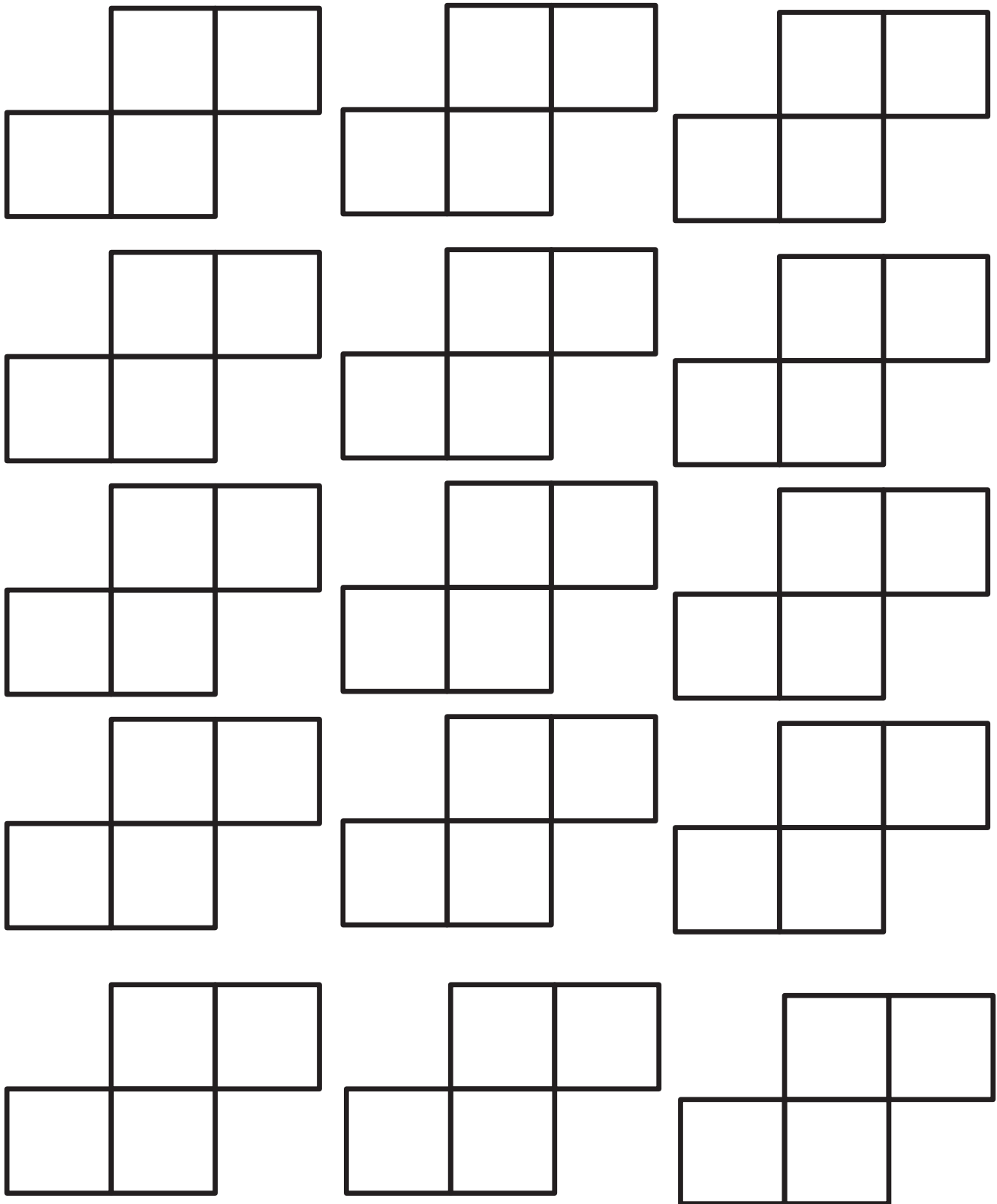

tetrominoes



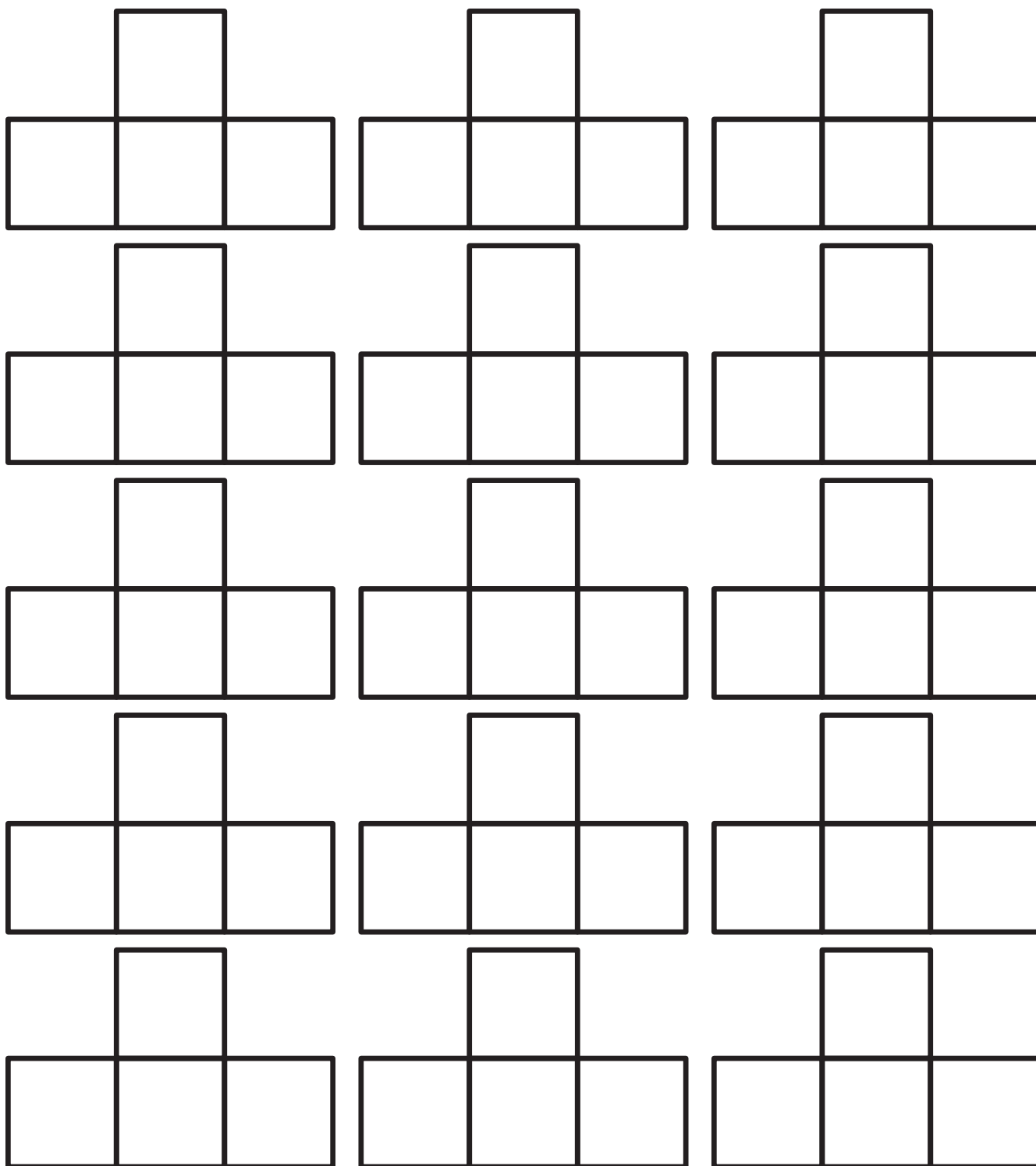

---

tetrominoes

## Lesson 8

**Objective:** Create a tangram puzzle and observe relationships among the shapes.

### Suggested Lesson Structure

■ Fluency Practice	(15 minutes)
■ Concept Development	(35 minutes)
■ Student Debrief	(10 minutes)
<b>Total Time</b>	<b>(60 minutes)</b>

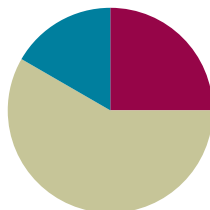

### Fluency Practice (15 minutes)

- Multiply by 6 **3.OA.7** (7 minutes)
- Equivalent Counting with Units of 8 **3.OA.7** (4 minutes)
- Shade Rectangles of Equal Area **3.G.2** (4 minutes)

### Multiply by 6 (7 minutes)

Materials: (S) Multiply by 6 (1–5) Pattern Sheet

Note: This activity builds fluency with multiplication facts using units of 6. It works toward students knowing from memory all products of two one-digit numbers. See Lesson 1 for the directions for administration of a Multiply-By Pattern Sheet.

T: (Write  $5 \times 6 = \underline{\quad}$ .) Let's skip-count up by sixes to find the answer. (Raise a finger for each number to track the count. Record the skip-count answers on the board.)

S: 6, 12, 18, 24, 30.

T: (Circle 30, and write  $5 \times 6 = 30$  above it. Write  $3 \times 6 = \underline{\quad}$ .) Let's skip-count up by sixes again. (Track with fingers as students count.)

S: 6, 12, 18.

T: Let's see how we can skip-count down to find the answer, too. Start at 30 with 5 fingers, 1 for each six. (Count down with fingers as students say the numbers.)

S: 30 (five fingers), 24 (4 fingers), 18 (3 fingers).

Repeat the process for  $4 \times 6$ .

T: (Distribute the Multiply by 6 Pattern Sheet.) Let's practice multiplying by 6. Be sure to work left to right across the page.

### Equivalent Counting with Units of 8 (4 minutes)

Note: This activity builds fluency with multiplication facts using units of 8. The progression builds in complexity. Work students up to the highest level of complexity where they can confidently participate.

T: Count to 10. (Write as students count. See the chart below.)

S: 1, 2, 3, 4, 5, 6, 7, 8, 9, 10.

1	2	3	4	5	6	7	8	9	10
1 eight	2 eights	3 eights	4 eights	5 eights	6 eights	7 eights	8 eights	9 eights	10 eights
8	16	24	32	40	48	56	64	72	80
1 eight	16	3 eights	32	5 eights	48	7 eights	64	9 eights	80
8	2 eights	24	4 eights	40	6 eights	56	8 eights	72	10 eights

T: (Write 1 eight beneath the 1.) Count to 10 eights. (Write as students count.)

S: 1 eight, 2 eights, 3 eights, 4 eights, 5 eights, 6 eights, 7 eights, 8 eights, 9 eights, 10 eights.

T: Count by eights to 80. (Write as students count.)

S: 8, 16, 24, 32, 40, 48, 56, 64, 72, 80.

T: (Write 1 eight beneath the 8. Write 16 beneath the 16.) I'm going to give you a challenge. Let's alternate between saying the units of eight and the number. (Write as students count.)

S: 1 eight, 16, 3 eights, 32, 5 eights, 48, 7 eights, 64, 9 eights, 80.

T: (Write 8 beneath 1 eight and 2 eights beneath the 16.) Let's alternate again. (Write as students count.)

S: 8, 2 eights, 24, 4 eights, 40, 6 eights, 56, 8 eights, 72, 10 eights.

### Shade Rectangles of Equal Area (4 minutes)

Materials: (S) Personal white board with grid paper

Note: This activity reviews Lesson 7.

T: (Write Area = 6 square units.) On your grid paper, shade a rectangle with an area of 6 square units with one row.

S: (Shade a 1 unit by 6 unit rectangle.)

T: Shade a rectangle with the same area using two rows.

S: (Shade a 2 unit by 3 unit rectangle.)

T: (Write Area = 8 square units.) Shade a rectangle with an area of 8 square units.

S: (Shade a 1 unit by 8 unit rectangle, 2 unit by 4 unit rectangle, 4 unit by 2 unit rectangle, or 8 unit by 1 unit rectangle.)

T: Shade a rectangle with different side lengths but the same area.

S: (Shade a rectangle with different side lengths but the same area.)

Repeat process for Area = 12 square units.

## Concept Development (35 minutes)

Materials: (T)  $8\frac{1}{2}'' \times 11''$  sheet of paper, scissors (S)  $8\frac{1}{2}'' \times 11''$  sheet of paper, scissors, Problem Set

### Part 1: Create a tangram puzzle.

Note: Have students store their tangram pieces to be used in Lesson 9.

- T: Today, we will cut out different shapes from this one large shape. What is this shape? (Hold up a sheet of paper.)
- S: A rectangle.

#### Problem 1

- T: First, we need to make a square. Fold your paper so that a shorter side lies along a longer side. Cut off the extra strip of paper. Unfold the remaining paper. (Model.)

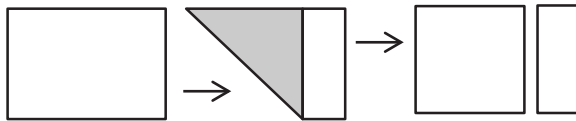

- T: We have drawn diagonals inside quadrilaterals and discovered they can be decomposed into what two shapes?
- S: Two triangles.
- T: Look how I fold my paper down the diagonal line that goes through the middle of the square. (Fold and unfold the paper.) Do I get the same shapes?
- S: Yes. You get two triangles!
- T: Fold your square on the diagonal. Then, cut out the two triangles on your paper as I cut out my triangles. (Cut out the triangles as students cut out the triangles.) How many pieces do you have now?
- S: Two pieces!
- T: Draw and label these two new shapes in Problem 1 on the Problem Set.
- S: (Draw and label.)

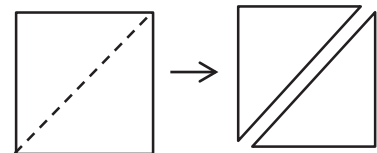

#### NOTES ON MULTIPLE MEANS OF ENGAGEMENT:

Give English language learners and others who may not otherwise quickly articulate names of polygons a fair chance to participate. Offer the alternative of nonverbal responses, such as pointing to a rectangle, triangle, quadrilateral, trapezoid, or square, or by gesturing or drawing on personal white boards. To preserve the lesson, students may be allowed to respond in their first languages. However, offer students ample practice and encouragement to speak polygon names in English prior to and after the lesson.

**Problem 2**

T: Take one of your triangles. (Model.) Fold it in half to make two equal sides, and crease it. Open the paper, and cut on the fold. (Allow students time to fold and cut.) Which smaller shapes is the big triangle composed of?

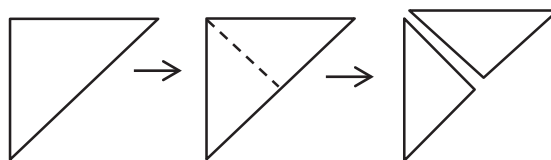

S: Two smaller triangles.

T: Draw and label these two new shapes in Problem 2.

S: (Draw and label.)

**Problem 3**

T: Take the remaining big triangle. (Model.) First, fold it in half to make our two triangles. Then, open the paper, and fold the tip of the triangle down to meet the bottom side of the triangle in the middle. Make a horizontal crease, and open it up. Cut only on the horizontal crease. What shapes did we make?

S: A quadrilateral and a triangle. → A trapezoid and a smaller triangle.

T: Draw and label these two new shapes in Problem 3 as a trapezoid and triangle.

S: (Draw and label.)

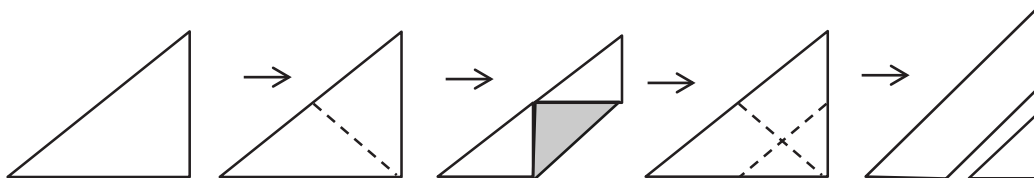
**Problem 4**

T: Take the trapezoid. Fold it in half, and cut it on the fold. Now you have two of what type of shape?

S: Quadrilaterals. → Trapezoids.

T: Draw and label these two new shapes in Problem 4.

S: (Draw and label.)

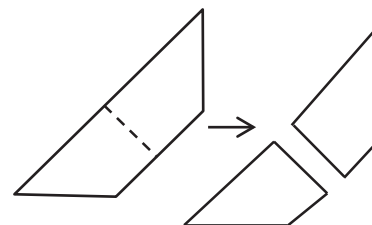
**Problem 5**

T: Take one of the trapezoids, and fold the longest point in. Make the long point meet the opposite corner, and crease it. Open it up, and cut on the fold. What shapes did we make?

S: We made a triangle and a square.

T: Draw and label these two new shapes in Problem 5.

S: (Draw and label.)

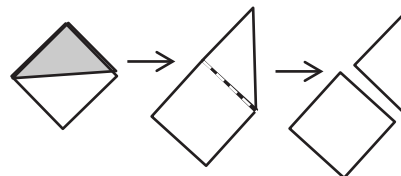

**Problem 6**

T: Use the last trapezoid. Put the longest side at the bottom, with the right angles to the left. Fold the bottom left angle up to meet the diagonal corner, and crease it. Open it up, and cut on the crease line. (Allow students time to fold and cut.) What shapes did we make?

S: We made a small triangle and a parallelogram.

T: Draw and label these two new shapes in Problem 6.

S: (Draw and label.)

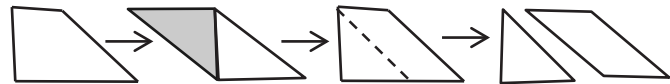
**Part 2: Recompose shapes to form a square.****MP.1**

T: Put your pieces back together to form the large square with which we started. (Allow students ample time to position the pieces. Make every effort not to interfere as students work at positioning the shapes during this sequence of the lesson. Encourage students to persevere, providing the least direction possible. Have students who finish quickly shuffle their pieces and try to make new shapes.)

T: Great job! These seven pieces that form a large square are called a **tangram**. You can make many different and interesting shapes by combining some or all of the parts.

Students complete Problems 7(a) and 7(b).

**Student Debrief (10 minutes)**

**Lesson Objective:** Create a tangram puzzle and observe relationships among the shapes.

The Student Debrief is intended to invite reflection and active processing of the total lesson experience.

Invite students to review their solutions for the Problem Set. They should check work by comparing answers with a partner before going over answers as a class. Look for misconceptions or misunderstandings that can be addressed in the Debrief. Guide students in a conversation to debrief the Problem Set and process the lesson.

Any combination of the questions below may be used to lead the discussion.

- How do you know the triangles in Problem 1 have right angles without having to check with your tool?

Name Gina Date \_\_\_\_\_

1. Fold and cut the square on the diagonal. Draw and label your 2 new shapes below.

2. Fold and cut one of the triangles in half. Draw and label your 2 new shapes below.

3. Fold twice and cut your large triangle. Draw and label your 2 new shapes below.

4. Fold and cut your trapezoid in half. Draw and label your 2 new shapes below.

- What do you notice about the size and shape of the triangles in Problem 2? Are they equal in size? How do you know? Are they regular polygons?
- Out of the seven **tangram** pieces, how many shapes are triangles? How many shapes are quadrilaterals? Are any of the shapes regular polygons?
- Explain to your partner the steps you took to recompose the seven shapes to a square.
- Share your answers to Problem 7(b). What was challenging? What are some strategies you used to recompose the square?

### Exit Ticket (3 minutes)

After the Student Debrief, instruct students to complete the Exit Ticket. A review of their work will help with assessing students' understanding of the concepts that were presented in today's lesson and planning more effectively for future lessons. The questions may be read aloud to the students.

5. Fold and cut one of your trapezoids. Draw and label your 2 new shapes below.

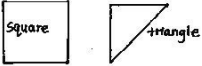

6. Fold and cut your second trapezoid. Draw and label your 2 new shapes below.



7. Reconstruct the original square using the seven shapes.

a. Draw lines inside the square below to show how the shapes go together to form the square. The first one has been done for you.

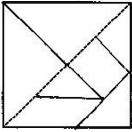

b. Describe the process of forming the square. What was easy and what was challenging?

*I first put the 2 big triangles together to make the bigger triangle. That was the easy part. Putting the smaller shapes altogether was more challenging. I went back to my problem set and worked backwards to re-make the square.*

Multiply.

$6 \times 1 = \underline{\quad\quad}$      $6 \times 2 = \underline{\quad\quad}$      $6 \times 3 = \underline{\quad\quad}$      $6 \times 4 = \underline{\quad\quad}$

$6 \times 5 = \underline{\quad\quad}$      $6 \times 1 = \underline{\quad\quad}$      $6 \times 2 = \underline{\quad\quad}$      $6 \times 1 = \underline{\quad\quad}$

$6 \times 3 = \underline{\quad\quad}$      $6 \times 1 = \underline{\quad\quad}$      $6 \times 4 = \underline{\quad\quad}$      $6 \times 1 = \underline{\quad\quad}$

$6 \times 5 = \underline{\quad\quad}$      $6 \times 1 = \underline{\quad\quad}$      $6 \times 2 = \underline{\quad\quad}$      $6 \times 3 = \underline{\quad\quad}$

$6 \times 2 = \underline{\quad\quad}$      $6 \times 4 = \underline{\quad\quad}$      $6 \times 2 = \underline{\quad\quad}$      $6 \times 5 = \underline{\quad\quad}$

$6 \times 2 = \underline{\quad\quad}$      $6 \times 1 = \underline{\quad\quad}$      $6 \times 2 = \underline{\quad\quad}$      $6 \times 3 = \underline{\quad\quad}$

$6 \times 1 = \underline{\quad\quad}$      $6 \times 3 = \underline{\quad\quad}$      $6 \times 2 = \underline{\quad\quad}$      $6 \times 3 = \underline{\quad\quad}$

$6 \times 4 = \underline{\quad\quad}$      $6 \times 3 = \underline{\quad\quad}$      $6 \times 5 = \underline{\quad\quad}$      $6 \times 3 = \underline{\quad\quad}$

$6 \times 4 = \underline{\quad\quad}$      $6 \times 1 = \underline{\quad\quad}$      $6 \times 4 = \underline{\quad\quad}$      $6 \times 2 = \underline{\quad\quad}$

$6 \times 4 = \underline{\quad\quad}$      $6 \times 3 = \underline{\quad\quad}$      $6 \times 4 = \underline{\quad\quad}$      $6 \times 5 = \underline{\quad\quad}$

$6 \times 4 = \underline{\quad\quad}$      $6 \times 5 = \underline{\quad\quad}$      $6 \times 1 = \underline{\quad\quad}$      $6 \times 5 = \underline{\quad\quad}$

$6 \times 2 = \underline{\quad\quad}$      $6 \times 5 = \underline{\quad\quad}$      $6 \times 3 = \underline{\quad\quad}$      $6 \times 5 = \underline{\quad\quad}$

$6 \times 4 = \underline{\quad\quad}$      $6 \times 2 = \underline{\quad\quad}$      $6 \times 4 = \underline{\quad\quad}$      $6 \times 3 = \underline{\quad\quad}$

$6 \times 5 = \underline{\quad\quad}$      $6 \times 3 = \underline{\quad\quad}$      $6 \times 2 = \underline{\quad\quad}$      $6 \times 4 = \underline{\quad\quad}$

$6 \times 3 = \underline{\quad\quad}$      $6 \times 5 = \underline{\quad\quad}$      $6 \times 2 = \underline{\quad\quad}$      $6 \times 4 = \underline{\quad\quad}$

multiply by 6 (1–5)



Name \_\_\_\_\_ Date \_\_\_\_\_

1. Fold and cut the square on the diagonal. Draw and label your 2 new shapes below.

2. Fold and cut one of the triangles in half. Draw and label your 2 new shapes below.

3. Fold twice, and cut your large triangle. Draw and label your 2 new shapes below.

4. Fold and cut your trapezoid in half. Draw and label your 2 new shapes below.

5. Fold and cut one of your trapezoids. Draw and label your 2 new shapes below.
6. Fold and cut your second trapezoid. Draw and label your 2 new shapes below.
7. Reconstruct the original square using the seven shapes.
- a. Draw lines inside the square below to show how the shapes go together to form the square. The first one has been done for you.

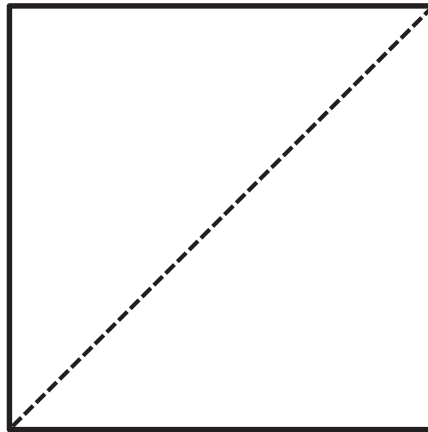

- b. Describe the process of forming the square. What was easy, and what was challenging?

Name \_\_\_\_\_

Date \_\_\_\_\_

Choose three shapes from your tangram puzzle. Trace them below. Label the name of each shape, and describe *at least* one attribute that they have in common.

Name \_\_\_\_\_

Date \_\_\_\_\_

1. Draw a line to divide the square below into 2 equal triangles.



2. Draw a line to divide the triangle below into 2 equal, smaller triangles.

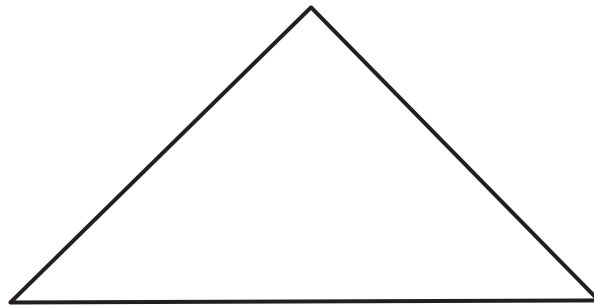

3. Draw a line to divide the trapezoid below into 2 equal trapezoids.



4. Draw 2 lines to divide the quadrilateral below into 4 equal triangles.

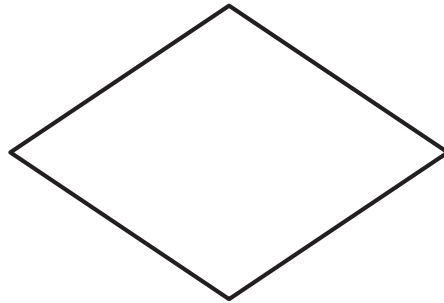

5. Draw 4 lines to divide the square below into 8 equal triangles.

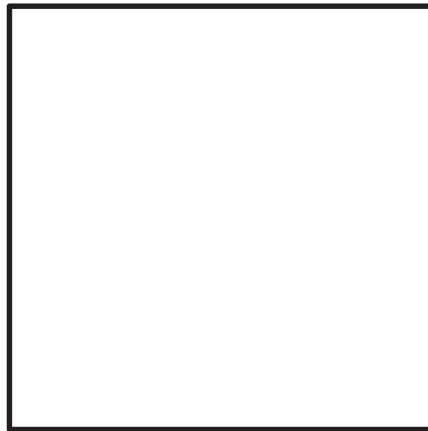

6. Describe the steps you took to divide the square in Problem 5 into 8 equal triangles.

## Lesson 9

**Objective:** Reason about composing and decomposing polygons using tangrams.

### Suggested Lesson Structure

■ Fluency Practice	(12 minutes)
■ Application Problem	(5 minutes)
■ Concept Development	(33 minutes)
■ Student Debrief	(10 minutes)
<b>Total Time</b>	<b>(60 minutes)</b>

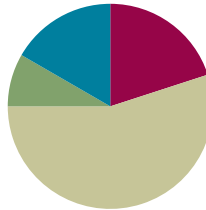

### Fluency Practice (12 minutes)

- Multiply by 6 **3.OA.7** (8 minutes)
- Equivalent Counting with Units of 9 **3.OA.7** (4 minutes)

### Multiply by 6 (8 minutes)

Materials: (S) Multiply by 6 (6–10) Pattern Sheet

Note: This activity builds fluency with multiplication facts using units of 6. It works toward students knowing from memory all products of two one-digit numbers. See Lesson 1 for the directions for administration of a Multiply-By Pattern Sheet.

T: (Write  $7 \times 6 = \underline{\quad}$ .) Let's skip-count up by sixes. I'll raise a finger for each six. (Raise a finger for each number to track the count.)

S: 6, 12, 18, 24, 30, 36, 42.

T: Let's skip-count up by sixes starting at 30. Why is 30 a good place to start?

S: It's a fact we already know, so we can use it to figure out a fact we don't know.

T: (Track with fingers as students say the numbers.)

S: 30 (5 fingers), 36 (6 fingers), 42 (7 fingers).

T: Let's see how we can skip-count down to find the answer, too. Start at 60 with 10 fingers, 1 for each six. (Count down with fingers as students say the numbers.)

S: 60 (10 fingers), 54 (9 fingers), 48 (8 fingers), 42 (7 fingers).

Continue with the following possible sequence:  $9 \times 6$ ,  $6 \times 6$ , and  $8 \times 6$ .

T: (Distribute the Multiply by 6 Pattern Sheet.) Let's practice multiplying by 6. Be sure to work left to right across the page.

### Equivalent Counting with Units of 9 (4 minutes)

Note: This activity builds fluency with multiplication facts using units of 9. The progression builds in complexity. Work students up to the highest level of complexity where they can confidently participate.

T: Count to 10. (Write as students count. See the chart below.)

S: 1, 2, 3, 4, 5, 6, 7, 8, 9, 10.

1	2	3	4	5	6	7	8	9	10
1 nine	2 nines	3 nines	4 nines	5 nines	6 nines	7 nines	8 nines	9 nines	10 nines
9	18	27	36	45	54	63	72	81	90
1 nine	18	3 nines	36	5 nines	54	7 nines	72	9 nines	90
9	2 nines	27	4 nines	45	6 nines	63	8 nines	81	10 nines

T: (Write 1 nine beneath the 1.) Count to 10 nines. (Write as students count.)

S: 1 nine, 2 nines, 3 nines, 4 nines, 5 nines, 6 nines, 7 nines, 8 nines, 9 nines, 10 nines.

T: Count by nines to 90. (Write as students count.)

S: 9, 18, 27, 36, 45, 54, 63, 72, 81, 90.

T: (Write 1 nine beneath the 9. Write 18 beneath the 18.) I'm going to give you a challenge. Let's alternate between saying the units of nine and the number. (Write as students count.)

S: 1 nine, 18, 3 nines, 36, 5 nines, 54, 7 nines, 72, 9 nines, 90.

T: (Write 9 beneath 1 nine and 2 nines beneath the 18.) Let's alternate again. (Write as students count.)

S: 9, 2 nines, 27, 4 nines, 45, 6 nines, 63, 8 nines, 81, 10 nines.

### Application Problem (5 minutes)

Name at least two attributes that a trapezoid, a square, and a parallelogram all have in common. Draw a diagram to support your ideas.

Note: This problem is designed to bridge learning from prior lessons and lead up to the Concept Development for the current lesson.

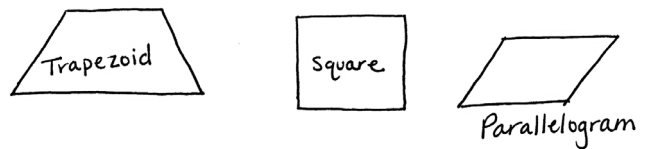

All of these have one or more sets of parallel lines. They are also all quadrilaterals. They could all have right angles too:

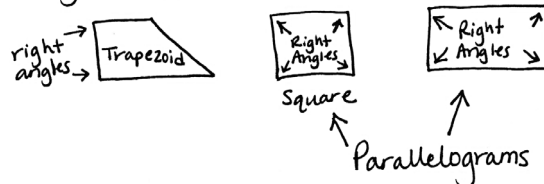

**Concept Development (33 minutes)**

Materials: (S) Tangram pieces (from Lesson 8), blank piece of paper, Problem Set

**Problem 1**

Use at least two tangram pieces to make and draw two of each of the following shapes. Draw lines to show where the tangram pieces meet.

- A rectangle that does not have all equal sides.
- A triangle.
- A parallelogram.
- A trapezoid.

T: Use the square and the two small triangles to make a rectangle. (Allow students time to work.) Estimate to draw your rectangle in Problem 1(a). Draw lines to show where the triangles and square meet to make the rectangle.

S: (Draw a rectangle in Problem 1(a).)

T: Use at least two tangram pieces to make another rectangle. (Allow students time to work.) Which shapes did you use to make another rectangle?

S: I used the medium triangle and the two small triangles. → I used the square, the medium triangle, and the two small triangles. → I used the square, the medium triangle, the two small triangles, and the parallelogram.

T: Compare your rectangle to a partner's. Discuss how they are similar and how they are different.

S: (Compare rectangles and discuss similarities and differences.)

T: Estimate to draw your rectangle in Problem 1(a). Draw lines to show where the tangram pieces meet to make the rectangle.

S: (Draw a rectangle in Problem 1(a).)

Continue the process to make the rest of the shapes in Problem 1.

Note: Students should try to make parallelograms and trapezoids that are not rectangles.

**Problem 2**

Use your two smallest triangles to create a square, a parallelogram, and a triangle. Show how you created them below.

T: Use the two small triangles to make a square. (Allow students time to work.) Estimate to draw your square in Problem 2. Draw lines to show where the triangles meet to make the square.

S: (Draw a square in Problem 2.)



**NOTES ON  
MULTIPLE MEANS  
OF ACTION AND  
EXPRESSION:**

It may be beneficial to have a variety of tangrams to meet the needs of students. Plastic or virtual tangrams may be easier for some students to manipulate. Alternatively, tangram pieces (from Lesson 8) can be copied on heavier paper, such as cardstock.



- T: Compare the square you made using two small triangles with the square tangram piece. What do you notice?
- S: They're the same! → Two small triangles equal the square tangram piece!
- T: Now, use the two small triangles to make a parallelogram. (Allow students time to work.) Estimate to draw your parallelogram in Problem 2. Draw lines to show where the triangles meet to make the parallelogram.
- S: (Draw a parallelogram in Problem 2.)
- T: Finally, use the two small triangles to make a new triangle. (Allow students time to work.) Estimate to draw your triangle in Problem 2. Draw lines to show where the small triangles meet to make the new triangle.
- S: (Draw a triangle in Problem 2.)
- T: Talk to a partner: Compare the size of the parallelogram and the new triangle that you made to the size of the square tangram piece.
- S: They're all equal! → We saw that the two small triangles are the same size as the square. Since we used the two small triangles to make the parallelogram and the new triangle, then those shapes are the same size as the square tangram piece.

### Problems 3 and 4

Problem 3: Create your own shape on a separate sheet of paper using all seven pieces. Describe its attributes below.

Problem 4: Trade your outline with a partner to see if you can re-create his shape using your tangram pieces. Reflect on your experience below. What was easy? What was challenging?

- T: Use all seven tangram pieces to create a new shape. Trace the outline of the shape on the blank piece of paper. Describe attributes of your shape in Problem 3. When you've answered Problem 3, trade outlines with a partner, and try to re-create your partner's shape with your tangram pieces. Then, answer Problem 4.

To prepare students, do the following:

- Remind them that the shapes they create cannot have gaps or overlaps.
- Generate a list of possible attributes that they might use to describe their new shapes.
- Clarify that, if necessary, they can gently guide their partners to re-create shapes if their partners have independently put forth significant effort in attempting to re-create the shapes.

If time permits, students can perform a gallery walk to view the shapes that their classmates created with all seven tangram pieces.

Note: Students need their tangram pieces for the Exit Ticket and Homework.

## Student Debrief (10 minutes)

**Lesson Objective:** Reason about composing and decomposing polygons using tangrams.

The Student Debrief is intended to invite reflection and active processing of the total lesson experience. Invite students to review their solutions for the Problem Set. They should check work by comparing answers with a partner before going over answers as a class. Look for misconceptions or misunderstandings that can be addressed in the Debrief. Guide students in a conversation to debrief the Problem Set and process the lesson.

Any combination of the questions below may be used to lead the discussion.

- Which shape was the most challenging for you to make in Problem 1? Why?
- Could you make the same shapes you made in Problem 2 with the large triangles? Why or why not?
- What can you say about the areas of the shapes you made in Problem 2? How about the areas of these shapes compared to the area of the square tangram piece?
- Compare your answer to Problem 3 with a partner's answer. What attributes do your shapes have in common? What attributes are different?
- Share your answers to Problem 4. Was something easy for you but challenging for others? Likewise, was something easy for others but challenging for you? Why?

## Exit Ticket (3 minutes)

After the Student Debrief, instruct students to complete the Exit Ticket. A review of their work will help with assessing students' understanding of the concepts that were presented in today's lesson and planning more effectively for future lessons. The questions may be read aloud to the students.

Name Gina Date \_\_\_\_\_

1. Use at least two tangram pieces to make and draw two of each of the following shapes. Draw lines to show where the tangram pieces meet.

a. A rectangle that does not have all equal sides.



b. A triangle.

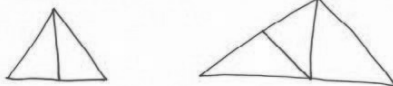

c. A parallelogram.



d. A trapezoid.



2. Use your two smallest triangles to create a square, a parallelogram, and a triangle. Show how you created them below.

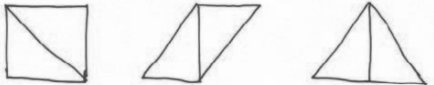

3. Create your own shape on a separate sheet of paper using all seven pieces. Describe its attributes below.

My shape has 6 sides, which means it's a hexagon. It's not a regular hexagon because the sides aren't all equal. My shape has 1 pair of parallel lines. My shape doesn't have any right angles.

4. Trade your outline with a partner to see if you can recreate his/her shape using your tangram pieces. Reflect on your experience below. What was easy? What was challenging?

My partner made a trapezoid. I thought it was easy to figure out the end pieces of the trapezoid because I figured out that it was the 2 large triangles. I thought it was challenging to figure out how to put the other 5 pieces to form the trapezoid. It took me a long time and a lot of tries!

Multiply.

$6 \times 1 = \underline{\quad\quad}$      $6 \times 2 = \underline{\quad\quad}$      $6 \times 3 = \underline{\quad\quad}$      $6 \times 4 = \underline{\quad\quad}$

$6 \times 5 = \underline{\quad\quad}$      $6 \times 6 = \underline{\quad\quad}$      $6 \times 7 = \underline{\quad\quad}$      $6 \times 8 = \underline{\quad\quad}$

$6 \times 9 = \underline{\quad\quad}$      $6 \times 10 = \underline{\quad\quad}$      $6 \times 5 = \underline{\quad\quad}$      $6 \times 6 = \underline{\quad\quad}$

$6 \times 5 = \underline{\quad\quad}$      $6 \times 7 = \underline{\quad\quad}$      $6 \times 5 = \underline{\quad\quad}$      $6 \times 8 = \underline{\quad\quad}$

$6 \times 5 = \underline{\quad\quad}$      $6 \times 9 = \underline{\quad\quad}$      $6 \times 5 = \underline{\quad\quad}$      $6 \times 10 = \underline{\quad\quad}$

$6 \times 6 = \underline{\quad\quad}$      $6 \times 5 = \underline{\quad\quad}$      $6 \times 6 = \underline{\quad\quad}$      $6 \times 7 = \underline{\quad\quad}$

$6 \times 6 = \underline{\quad\quad}$      $6 \times 8 = \underline{\quad\quad}$      $6 \times 6 = \underline{\quad\quad}$      $6 \times 9 = \underline{\quad\quad}$

$6 \times 6 = \underline{\quad\quad}$      $6 \times 7 = \underline{\quad\quad}$      $6 \times 6 = \underline{\quad\quad}$      $6 \times 7 = \underline{\quad\quad}$

$6 \times 8 = \underline{\quad\quad}$      $6 \times 7 = \underline{\quad\quad}$      $6 \times 9 = \underline{\quad\quad}$      $6 \times 7 = \underline{\quad\quad}$

$6 \times 8 = \underline{\quad\quad}$      $6 \times 6 = \underline{\quad\quad}$      $6 \times 8 = \underline{\quad\quad}$      $6 \times 7 = \underline{\quad\quad}$

$6 \times 8 = \underline{\quad\quad}$      $6 \times 9 = \underline{\quad\quad}$      $6 \times 9 = \underline{\quad\quad}$      $6 \times 6 = \underline{\quad\quad}$

$6 \times 9 = \underline{\quad\quad}$      $6 \times 7 = \underline{\quad\quad}$      $6 \times 9 = \underline{\quad\quad}$      $6 \times 8 = \underline{\quad\quad}$

$6 \times 9 = \underline{\quad\quad}$      $6 \times 8 = \underline{\quad\quad}$      $6 \times 6 = \underline{\quad\quad}$      $6 \times 9 = \underline{\quad\quad}$

$6 \times 7 = \underline{\quad\quad}$      $6 \times 9 = \underline{\quad\quad}$      $6 \times 6 = \underline{\quad\quad}$      $6 \times 8 = \underline{\quad\quad}$

$6 \times 9 = \underline{\quad\quad}$      $6 \times 7 = \underline{\quad\quad}$      $6 \times 6 = \underline{\quad\quad}$      $6 \times 8 = \underline{\quad\quad}$

multiply by 6 (6–10)

Name \_\_\_\_\_

Date \_\_\_\_\_

1. Use at least two tangram pieces to make and draw two of each of the following shapes. Draw lines to show where the tangram pieces meet.

a. A rectangle that does not have all equal sides.

b. A triangle.

c. A parallelogram.

d. A trapezoid.

2. Use your two smallest triangles to create a square, a parallelogram, and a triangle. Show how you created them below.
3. Create your own shape on a separate sheet of paper using all seven pieces. Describe its attributes below.
4. Trade your outline with a partner to see if you can re-create her shape using your tangram pieces. Reflect on your experience below. What was easy? What was challenging?

Name \_\_\_\_\_

Date \_\_\_\_\_

Nancy uses her tangram pieces to make a trapezoid without using the square piece. Below, sketch how she might have created her trapezoid.

Name \_\_\_\_\_

Date \_\_\_\_\_

1. Use at least two tangram pieces to make and draw each of the following shapes. Draw lines to show where the tangram pieces meet.

a. A triangle.

b. A square.

c. A parallelogram.

d. A trapezoid.

2. Use your tangram pieces to create the cat below. Draw lines to show where the tangram pieces meet.

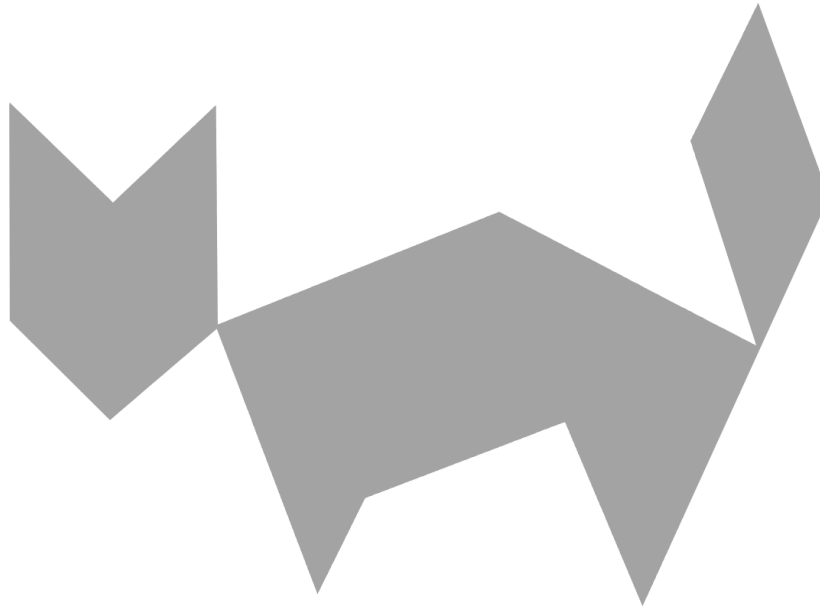

3. Use the five smallest tangram pieces to make a square. Sketch your square below, and draw lines to show where the tangram pieces meet.





## Topic C

## Problem Solving with Perimeter

## 3.MD.8, 3.G.1

<b>Focus Standard:</b>	3.MD.8	Solve real world and mathematical problems involving perimeters of polygons, including finding the perimeter given the side lengths, finding an unknown side length, and exhibiting rectangles with the same perimeter and different areas or with the same area and different perimeters.
<b>Instructional Days:</b>	8	
<b>Coherence -Links from:</b>	G2–M6	Foundations of Multiplication and Division
	G3–M3	Multiplication and Division with Units of 0, 1, 6–9, and Multiples of 10
	G3–M4	Multiplication and Area
<b>-Links to:</b>	G4–M3	Multi-Digit Multiplication and Division

Students are introduced to perimeter in Topic C. Conceptual exploration begins by creating tessellations. In Lessons 10 and 11, students decompose a quadrilateral. They rearrange the parts to form a new shape. They then use the new shape to tile, tracing its perimeter until a new larger shape (the complete tessellation) is formed. Through this work, students define perimeter as the boundary of a two-dimensional shape and use their new vocabulary in context as they describe the process of tessellating. These lessons begin the study of perimeter with unusual shapes to encourage flexible thinking about perimeter and avoid the misconception that it is a property of rectangles alone.

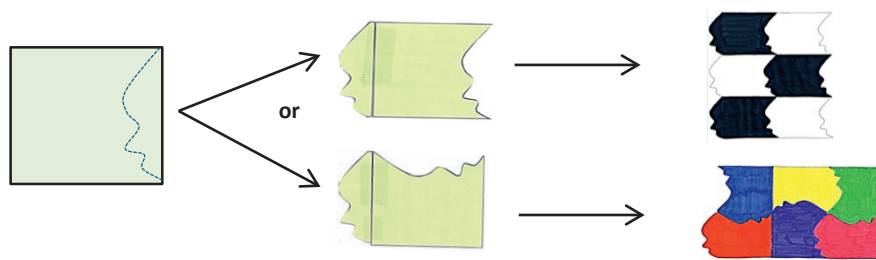

*Cut on the line. Then, slide the piece to the opposite side, or rotate it to an adjacent side to make a new shape.*

In Lesson 12, students measure side lengths and calculate perimeters. They measure the side lengths of polygons (in whole number units) using rulers and then use these side lengths to determine perimeter. Students attend to units as they solve and discuss the efficiency of strategies for adding side lengths. The complexity increases in Lesson 13 when students are given pictorial models, including the side lengths of polygons, from which they determine the perimeter.

Lesson 14 provides more complex problem solving; students determine the perimeter of a figure when whole number side length measurements are unknown. Students use their knowledge of attributes of shapes to fill in unknown information and then calculate the perimeter. For example, they may be told that a hexagon is regular and that one side length is 5 centimeters. Based on that information, students fill in the unknown side lengths and calculate the perimeter and discuss whether addition or multiplication is a more efficient strategy for solving the problem.

In Lesson 15, students apply their basic understanding of perimeter to real-world contexts. They explore how perimeter is used in everyday life and develop strategies for calculating perimeters using known information.

Lesson 16 extends students' knowledge of perimeter to circles. In this lesson, students wrap string around various circular objects, such as lids. Students measure their strings to the nearest quarter inch using rulers and record their measurements for comparison and discussion. This lesson reinforces that perimeter is a measurable attribute for any shape, not just polygons, and that those measurements can occur in both whole and fractional units.

Lesson 17 involves using all four operations to determine a perimeter and any unknown measurements. Students develop strategies for finding the perimeter of part of a larger shape, for example, the shaded rectangle in the figure below. In this example, students understand that they can subtract the known part of the length from the total length to find the unknown measurement. The unknown measurements may then be used to find the perimeter of the shaded rectangle.

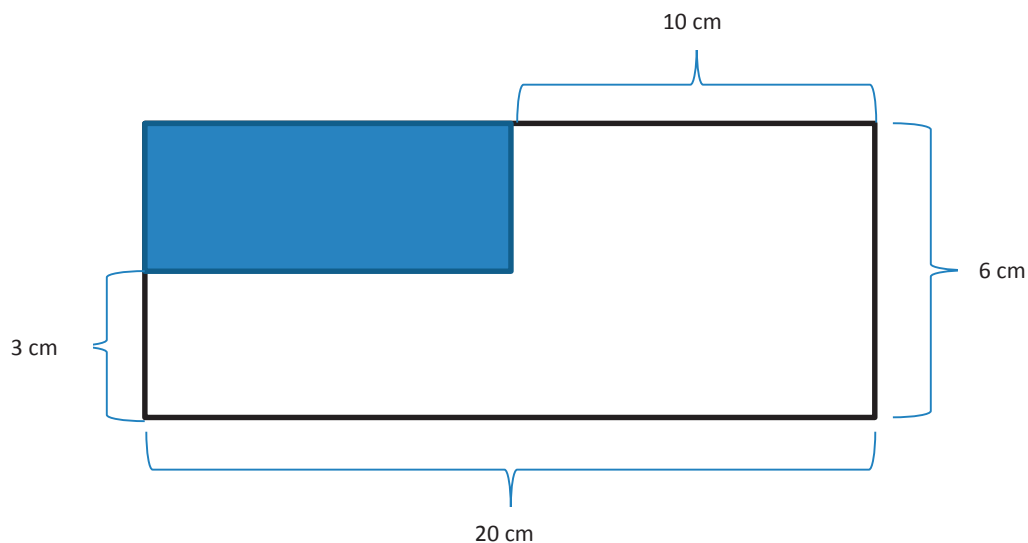

*What is the perimeter of the shaded rectangle?*

**A Teaching Sequence Toward Mastery of Problem Solving with Perimeter**

- Objective 1:** Decompose quadrilaterals to understand perimeter as the boundary of a shape.  
(Lesson 10)
- Objective 2:** Tessellate to understand perimeter as the boundary of a shape. (Optional.)  
(Lesson 11)
- Objective 3:** Measure side lengths in whole number units to determine the perimeter of polygons.  
(Lesson 12)
- Objective 4:** Explore perimeter as an attribute of plane figures and solve problems.  
(Lesson 13)
- Objective 5:** Determine the perimeter of regular polygons and rectangles when whole number measurements are unknown.  
(Lesson 14)
- Objective 6:** Solve word problems to determine perimeter with given side lengths.  
(Lesson 15)
- Objective 7:** Use string to measure the perimeter of various circles to the nearest quarter inch.  
(Lesson 16)
- Objective 8:** Use all four operations to solve problems involving perimeter and unknown measurements.  
(Lesson 17)

## Lesson 10

**Objective:** Decompose quadrilaterals to understand perimeter as the boundary of a shape.

### Suggested Lesson Structure

■ Fluency Practice	(12 minutes)
■ Application Problem	(8 minutes)
■ Concept Development	(30 minutes)
■ Student Debrief	(10 minutes)
<b>Total Time</b>	<b>(60 minutes)</b>

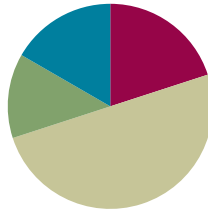

### Fluency Practice (12 minutes)

- Multiply by 7 **3.OA.7** (8 minutes)
- Equivalent Counting with Units of 2 **3.OA.7** (4 minutes)

### Multiply by 7 (8 minutes)

Materials: (S) Multiply by 7 (1–5) Pattern Sheet

Note: This activity builds fluency with multiplication facts using units of 7. It works toward students knowing from memory all the products of two one-digit numbers. See Lesson 1 for the directions for administration of a Multiply-By Pattern Sheet.

T: (Write  $5 \times 7 = \underline{\quad}$ .) Let's skip-count up by sevens to find the answer. (Raise a finger for each number to track the count. Record the skip-count answers on the board.)

S: 7, 14, 21, 28, 35.

T: (Circle 35, and write  $5 \times 7 = 35$  above it. Write  $3 \times 7 = \underline{\quad}$ .) Let's skip-count up by sevens again. (Track with fingers as students count.)

S: 7, 14, 21.

T: Let's see how we can skip-count down to find the answer, too. Start at 35 with 5 fingers, 1 for each seven. (Count down with fingers as students say the numbers.)

S: 35 (5 fingers), 28 (4 fingers), 21 (3 fingers).

Repeat the process for  $4 \times 7$ .

T: (Distribute the Multiply by 7 Pattern Sheet.) Let's practice multiplying by 7. Be sure to work left to right across the page.

### Equivalent Counting with Units of 2 (4 minutes)

Note: This activity builds fluency with multiplication facts using units of 2.

T: Count by twos to 20. (Write as students count. See the chart below.)

S: 2, 4, 6, 8, 10, 12, 14, 16, 18, 20.

T: (Write 1 two beneath the 2.) Count to 10 twos. (Write as students count.)

S: 1 two, 2 twos, 3 twos, 4 twos, 5 twos, 6 twos, 7 twos, 8 twos, 9 twos, 10 twos.

2	4	6	8	10	12	14	16	18	20
1 two	2 twos	3 twos	4 twos	5 twos	6 twos	7 twos	8 twos	9 twos	10 twos

T: Let's count to 10 twos again. This time, stop when I raise my hand.

S: 1 two, 2 twos, 3 twos.

T: (Raise hand.) Say the multiplication sentence.

S:  $3 \times 2 = 6$ .

T: Continue.

S: 4 twos, 5 twos.

T: (Raise hand.) Say the multiplication sentence.

S:  $5 \times 2 = 10$ .

T: Continue.

S: 6 twos, 7 twos, 8 twos.

T: (Raise hand.) Say the multiplication sentence.

S:  $8 \times 2 = 16$ .

Continue the process up to 10 twos and down to 1 two.

### Application Problem (8 minutes)

Trista uses all seven of her tangram pieces to make a square as shown. One side of the large square is 4 inches long. What is the total area of the two large triangles? Explain your answer.

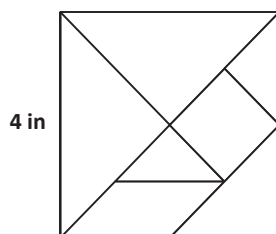

#### NOTES ON MULTIPLE MEANS OF REPRESENTATION:

Scaffold the Application Problem with questions such as the following:

- What do you know about the sides of a square?
- What other measures can you label?
- What is the area of the square?
- Shade the two large triangles. What is the shaded fraction of the square?
- What is the area of the two large triangles?

Area of the  
square:

$$4 \text{ in} \times 4 \text{ in} = 16 \text{ sq in}$$

$$\text{Area} = 16 \text{ sq in}$$

The total area of the 2 large triangles is 8 sq in. I know the 2 triangles make up half of the square. I found the area of the square and divided it by 2.

Area of the 2  
large triangles:

$$16 \text{ sq in} \div 2 = 8 \text{ sq in}$$

$$\text{Area} = 8 \text{ sq in}$$

Note: This problem reviews the work done with tangrams in Lessons 8 and 9. It also reviews the concept of area from Module 4. Students may not immediately recognize that the two large triangles make up half of the square. If necessary, have them use tangram pieces to demonstrate this before solving.

### Concept Development (30 minutes)

Materials: (T) 2" square on cardstock, scissors, tape (S) 2" square on cardstock, tape, crayons, Problem Set, scissors, black marker, red marker, white string

#### Problem 1: Decompose a square to define perimeter.

Note: Students should save the shape created here for Lesson 11.

Use a 2-inch square to answer the questions below.

- Trace the square in the space below with a red crayon.
- Trace the new shape you made with the square in the space below with a red crayon.
- Which shape has a greater perimeter? How do you know?
- Color the inside of the shapes in Problem 1 (a) and (b) with a blue crayon.
- Which color represents the perimeters of the shapes? How do you know?
- What does the other color represent? How do you know?
- Which shape has a greater area? How do you know?

T: (Give each student a 2-inch square.) Trace your 2-inch square in Problem 1(a) with a red crayon.

S: (Trace the square with a red crayon.)

T: (Distribute the white string.) Work with your partner to wrap the string around the outside edges of your square. (Model.) Partner A, hold the string in place. Partner B, use the black marker to mark the string where it meets the end after going all the way around once.

S: (Mark the string.)

T: Switch roles to help your partner mark his string.

S: (Switch roles and mark the string.)

T: Set your string aside. Draw a path from the top right-hand corner of the square to the bottom right-hand corner. Be creative! Your path shouldn't be straight, but you will cut along it. Keep that in mind as you draw. (Model.)

S: (Draw the path.)

T: Carefully cut along your path. (Model.)

S: (Cut along the path.)

T: Use your finger to trace around the edge of the piece you cut out. We call the boundary of the shape its **perimeter**. Say the word to yourself as you trace.

S: Perimeter. (Trace with finger.)

T: Slide the piece that you cut out to the opposite side of your square. Line up the straight edge of the piece that you cut out with the edge of the square. Tape the pieces together, making sure that there aren't any gaps. (Model.)

S: (Slide and tape.)

T: What happened to the perimeter of the shape you cut out?

S: It got curvy instead of straight. → Two sides changed, and two sides stayed the same. → Part of it is stuck to the square. → The new perimeter is the edge of the whole new shape we made by taping.

T: Work with a partner to wrap your string around your new shape. This time, use the red marker to mark the string where it meets the end after going all the way around once. Then, switch roles so your partner can mark her string.

**MP.3**

S: (Mark the string.)

T: The marks on your string represent the perimeters of the square and your new shape. Talk to a partner. Compare the perimeters of the square and your new shape.

S: The perimeter of my new shape is greater than the perimeter of the square. → Yeah! Mine too!

T: Did the area of the square change when you made your new shape? Talk to a partner.

S: We didn't get rid of any part of the square; we just changed the way it looks. → Yeah. The same amount of space is covered, so the area stays the same.

T: Follow the directions to complete Problem 1(b–g) on your Problem Set. (Allow students time to work.) Which color in Problem 1 (a) and (b) represents the perimeter of the shapes?

S: Red!

T: What does the color blue represent?

S: Area!

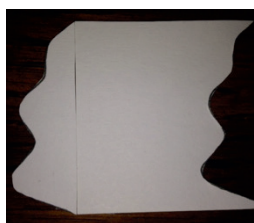
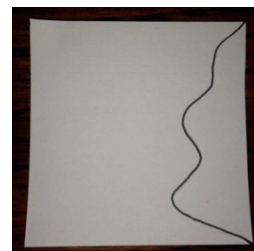

### Problem Set (5 minutes)

Students should do their personal best to complete Problems 2 and 3 of the Problem Set within the allotted 5 minutes.

## Student Debrief (10 minutes)

**Lesson Objective:** Decompose quadrilaterals to understand perimeter as the boundary of a shape.

The Student Debrief is intended to invite reflection and active processing of the total lesson experience.

Invite students to review their solutions for the Problem Set. They should check work by comparing answers with a partner before going over answers as a class. Look for misconceptions or misunderstandings that can be addressed in the Debrief. Guide students in a conversation to debrief the Problem Set and process the lesson.

Any combination of the questions below may be used to lead the discussion.

- Does the shape you drew in Problem 1(a) have the same **perimeter** as the shape your partner drew for Problem 1(a)? How do you know?
- Use your string to compare the perimeter of your new shape to your partner's. Whose shape has a greater perimeter? How do you know?
- How is area different from perimeter? Why did the perimeter of the shape change but the area stay the same?
- Explain to a partner how you could use your piece of string to figure out which shape has the greatest perimeter in Problem 2.

## Exit Ticket (3 minutes)

After the Student Debrief, instruct students to complete the Exit Ticket. A review of their work will help with assessing students' understanding of the concepts that were presented in today's lesson and planning more effectively for future lessons. The questions may be read aloud to the students.

Name Gina Date \_\_\_\_\_

1. Use a 2-inch square to answer the questions below.

a. Trace the square in the space below with a red crayon.



b. Trace the new shape you made with the square in the space below with a red crayon.

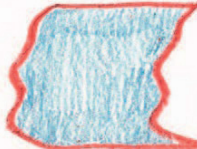

c. Which shape has a greater perimeter? How do you know?  
My new shape has a greater perimeter because when I marked both perimeters on my string, the mark for my new shape was further down the string.

d. Color the inside of the shapes in Problems 1(a) and 1(b) with a blue crayon.

e. Which color represents the perimeters of the shapes? How do you know?  
Red represents the perimeters because I traced the boundary of the shapes with red and the boundary is the perimeter.

f. What does the other color represent? How do you know?  
Blue represents the area because it shows how much space the shape takes up.

g. Which shape has a greater area? How do you know?  
Neither shape has a greater area! They have the same area because I just changed how the square looks, which doesn't change the area.

2. a. Outline the perimeter of the shapes below with a red crayon.



b. Explain how you know you outlined the perimeters of the shapes above.  
I know I outlined the perimeters of the shapes because I colored the boundary of each shape and the boundary of a shape is its perimeter.

3. Outline the perimeter of this piece of paper with a highlighter. ✓



Multiply

$7 \times 1 = \underline{\quad\quad}$      $7 \times 2 = \underline{\quad\quad}$      $7 \times 3 = \underline{\quad\quad}$      $7 \times 4 = \underline{\quad\quad}$

$7 \times 5 = \underline{\quad\quad}$      $7 \times 1 = \underline{\quad\quad}$      $7 \times 2 = \underline{\quad\quad}$      $7 \times 1 = \underline{\quad\quad}$

$7 \times 3 = \underline{\quad\quad}$      $7 \times 1 = \underline{\quad\quad}$      $7 \times 4 = \underline{\quad\quad}$      $7 \times 1 = \underline{\quad\quad}$

$7 \times 5 = \underline{\quad\quad}$      $7 \times 1 = \underline{\quad\quad}$      $7 \times 2 = \underline{\quad\quad}$      $7 \times 3 = \underline{\quad\quad}$

$7 \times 2 = \underline{\quad\quad}$      $7 \times 4 = \underline{\quad\quad}$      $7 \times 2 = \underline{\quad\quad}$      $7 \times 5 = \underline{\quad\quad}$

$7 \times 2 = \underline{\quad\quad}$      $7 \times 1 = \underline{\quad\quad}$      $7 \times 2 = \underline{\quad\quad}$      $7 \times 3 = \underline{\quad\quad}$

$7 \times 1 = \underline{\quad\quad}$      $7 \times 3 = \underline{\quad\quad}$      $7 \times 2 = \underline{\quad\quad}$      $7 \times 3 = \underline{\quad\quad}$

$7 \times 4 = \underline{\quad\quad}$      $7 \times 3 = \underline{\quad\quad}$      $7 \times 5 = \underline{\quad\quad}$      $7 \times 3 = \underline{\quad\quad}$

$7 \times 4 = \underline{\quad\quad}$      $7 \times 1 = \underline{\quad\quad}$      $7 \times 4 = \underline{\quad\quad}$      $7 \times 2 = \underline{\quad\quad}$

$7 \times 4 = \underline{\quad\quad}$      $7 \times 3 = \underline{\quad\quad}$      $7 \times 4 = \underline{\quad\quad}$      $7 \times 5 = \underline{\quad\quad}$

$7 \times 4 = \underline{\quad\quad}$      $7 \times 5 = \underline{\quad\quad}$      $7 \times 1 = \underline{\quad\quad}$      $7 \times 5 = \underline{\quad\quad}$

$7 \times 2 = \underline{\quad\quad}$      $7 \times 5 = \underline{\quad\quad}$      $7 \times 3 = \underline{\quad\quad}$      $7 \times 5 = \underline{\quad\quad}$

$7 \times 4 = \underline{\quad\quad}$      $7 \times 2 = \underline{\quad\quad}$      $7 \times 4 = \underline{\quad\quad}$      $7 \times 3 = \underline{\quad\quad}$

$7 \times 5 = \underline{\quad\quad}$      $7 \times 3 = \underline{\quad\quad}$      $7 \times 2 = \underline{\quad\quad}$      $7 \times 4 = \underline{\quad\quad}$

$7 \times 3 = \underline{\quad\quad}$      $7 \times 5 = \underline{\quad\quad}$      $7 \times 2 = \underline{\quad\quad}$      $7 \times 4 = \underline{\quad\quad}$

multiply by 7 (1–5)

Name \_\_\_\_\_

Date \_\_\_\_\_

1. Use a 2-inch square to answer the questions below.

a. Trace the square in the space below with a red crayon.

b. Trace the new shape you made with the square in the space below with a red crayon.

c. Which shape has a greater perimeter? How do you know?

d. Color the inside of the shapes in Problem 1 (a) and (b) with a blue crayon.

e. Which color represents the perimeters of the shapes? How do you know?

f. What does the other color represent? How do you know?

g. Which shape has a greater area? How do you know?

2. a. Outline the perimeter of the shapes below with a red crayon.

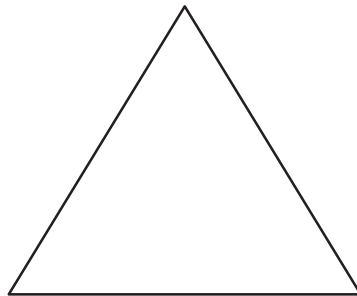
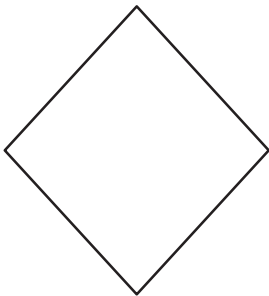

b. Explain how you know you outlined the perimeters of the shapes above.

3. Outline the perimeter of this piece of paper with a highlighter.

Name \_\_\_\_\_

Date \_\_\_\_\_

Jason paints the outside edges of a rectangle purple. Celeste paints the inside of the rectangle yellow.

1. Use your crayons to color the rectangle that Jason and Celeste painted.



2. Which color represents the perimeter of the rectangle? How do you know?

Name \_\_\_\_\_

Date \_\_\_\_\_

1. Trace the perimeter of the shapes below.

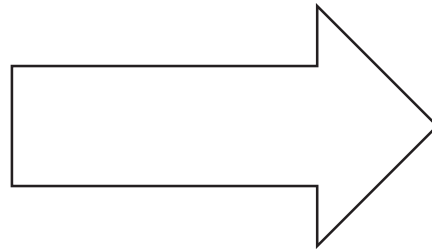
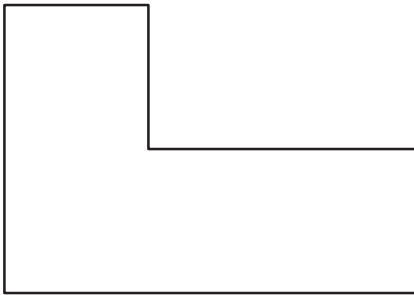
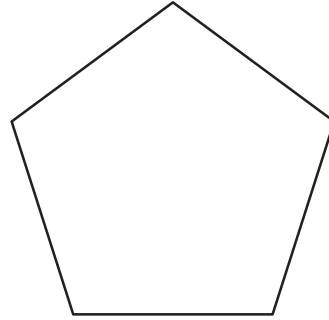
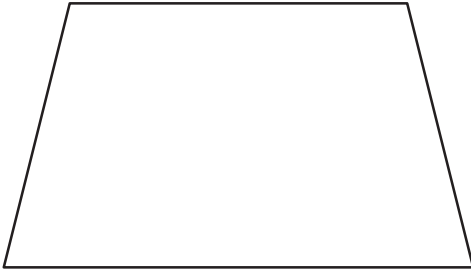

- a. Explain how you know you traced the perimeters of the shapes above.
- 
- 
- 
- 
- 
- 
- 
- 
- 
- 
- b. Explain how you could use a string to figure out which shape above has the greatest perimeter.

2. Draw a rectangle on the grid below.

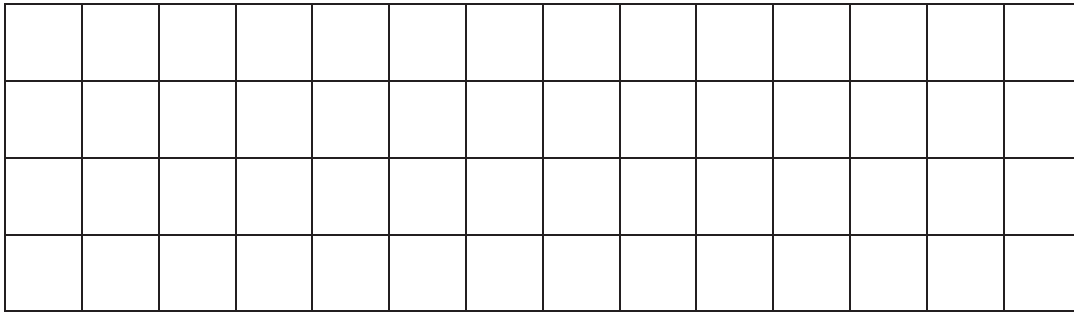

- Trace the perimeter of the rectangle.
  - Shade the area of the rectangle.
  - How is the perimeter of the rectangle different from the area of the rectangle?
3. Maya draws the shape shown below. Noah colors the inside of Maya's shape as shown. Noah says he colored the perimeter of Maya's shape. Maya says Noah colored the area of her shape. Who is right? Explain your answer.

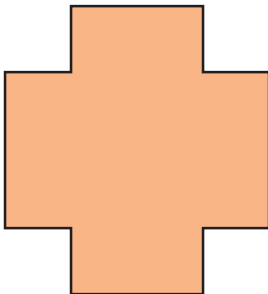

## Lesson 11

**Objective:** Tessellate to understand perimeter as the boundary of a shape. (Optional.)

### Suggested Lesson Structure

■ Concept Development	(50 minutes)
■ Student Debrief	(10 minutes)
<b>Total Time</b>	<b>(60 minutes)</b>

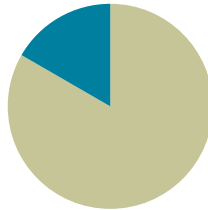

### Concept Development (50 minutes)

**Materials:** (T) Shape created in Lesson 10 (S) Shape created in Lesson 10, blank piece of paper, crayons, white string, black marker, Problem Set

#### Problem 1(a–c): Tessellate to explore perimeter.

Follow the directions below using the shape you created yesterday.

- Tessellate your shape on a blank piece of paper.
- Color your tessellation to create a pattern.
- Outline the perimeter of your tessellation with a highlighter.

T: (Project Image A.) What shape do you see repeated in this figure?

S: Hexagons!

T: Do all of the hexagons look the same? Discuss with your partner.

S: Some are yellow, and some are orange. → But they all look like they're the same size.

T: You're right. All of the hexagons are the same size. In fact, this figure was made by tracing the same hexagon over and over. Do you see any gaps or overlaps between each hexagon?

S: No!

T: We call this figure a **tessellation** because it was made by copying a shape many times, without any gaps or overlaps. You're going to create your own tessellation using the shape you made yesterday.



#### NOTES ON MULTIPLE MEANS OF REPRESENTATION:

Topic C presents two possible optional lessons related to perimeter, including this lesson. The second option is a culminating lesson using the text below, along with the lesson plan found at the end of that text.

Burns, Marilyn. *Spaghetti and Meatballs for All! A Mathematical Story*. New York: Scholastic Press, 1997.

With the Marilyn Burns option, the recommended sequence is after Lesson 17 and before the Mid-Module Assessment because the lesson explores the relationship between perimeter and area. It works well as a culmination of Topic C while anticipating Topic D, which incorporates area.

Image A

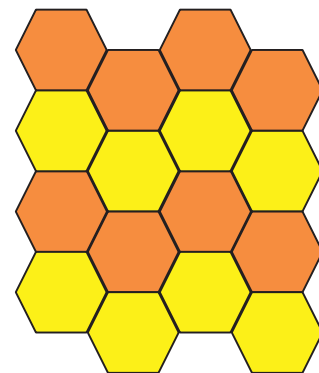

Prepare students by doing the following:

- Model how to tessellate, emphasizing that there should not be any gaps or overlaps. As students tessellate, ask them to notice how the perimeter of the figure increases with each tessellation.
- Convey the idea that even though these tessellations are restricted by the paper size, a tessellation could, in fact, go on forever.
- Remind students that when coloring their designs, they should be creating a pattern.

If time permits, students can outline the perimeter of each tessellated shape within their designs using a black marker.

When tessellations are complete, allow time for a gallery walk.

**Problem 1(d) and Problem 2: Use a string to measure and compare perimeters.**

Problem 1(d): Use a string to measure the perimeter of your tessellation.

Problem 2: Compare the perimeter of your tessellation to a partner's. Whose tessellation has a greater perimeter? How do you know?

Have students work with a partner and use a white string to measure the total perimeter of the figure they created when they tessellated. They should switch roles so that each partner can measure the total perimeter of his figure. Have them compare the perimeters of their figures using the marks on their strings and then answer Problem 2 on the Problem Set.

**Problem Set (5 minutes)**

Students should do their personal best to complete Problems 3 and 4 of the Problem Set within the allotted 5 minutes.



**NOTES ON  
MULTIPLE MEANS  
OF ACTION AND  
EXPRESSION:**

Students working below grade level and others may find tessellating concrete or virtual pattern blocks, or drawing on grid paper, a helpful step toward tessellating their shapes on a blank piece of paper.



**NOTES ON  
MULTIPLE MEANS  
OF ACTION AND  
EXPRESSION:**

Support English language learners as they write their responses to Problems 2–4 on the Problem Set. Provide sentence starters and a word bank.

Sentence starters may include the following:

“The tessellation with the longer perimeter was \_\_\_\_.”

“I know because...”

Possible words for the word bank may include the following:

measure	string	more
shorter	tessellate	row



### Student Debrief (10 minutes)

**Lesson Objective:** Tessellate to understand perimeter as the boundary of a shape. (Optional.)

The Student Debrief is intended to invite reflection and active processing of the total lesson experience. Invite students to review their solutions for the Problem Set. They should check work by comparing answers with a partner before going over answers as a class. Look for misconceptions or misunderstandings that can be addressed in the Debrief. Guide students in a conversation to debrief the Problem Set and process the lesson.

Any combination of the questions below may be used to lead the discussion.

- Explain to a partner the steps you used to tessellate your shape in Problem 1(a).
- Share your answer to Problem 3. How could you decrease the perimeter of your **tessellation**?
- Use your string to measure the perimeter of the piece of paper on which you made your tessellation. Compare the perimeter of the paper to the perimeter of your tessellation.
- Discuss the tessellations you saw during the gallery walk. Were any the same? Why or why not? How were they similar to your tessellation? How were they different?

### Exit Ticket (3 minutes)

After the Student Debrief, instruct students to complete the Exit Ticket. A review of their work will help with assessing students' understanding of the concepts that were presented in today's lesson and planning more effectively for future lessons. The questions may be read aloud to the students.

Name Gina Date \_\_\_\_\_

- Follow the directions below, using the shape you created yesterday.
  - Tessellate your shape on a blank piece of paper.
  - Color your tessellation to create a pattern.
  - Outline the perimeter of your tessellation with a highlighter.
  - Use a string to measure the perimeter of your tessellation.
- Compare the perimeter of your tessellation to a partner's. Whose tessellation has a greater perimeter? How do you know?
 

My tessellation has a greater perimeter. I know because my partner and I compared our strings. The mark on my string that represents the perimeter was further down on the string than my partner's.
- How could you increase the perimeter of your tessellation?
 

I could increase the perimeter of my tessellation by tessellating more shapes. If I tessellated another row of shapes, that would increase the perimeter.
- How would overlapping your shape when you tessellated change the perimeter of your tessellation?
 

If I had overlaps, the shapes wouldn't fit together. If I had overlaps with the same number of tessellated shapes, the perimeter would decrease.

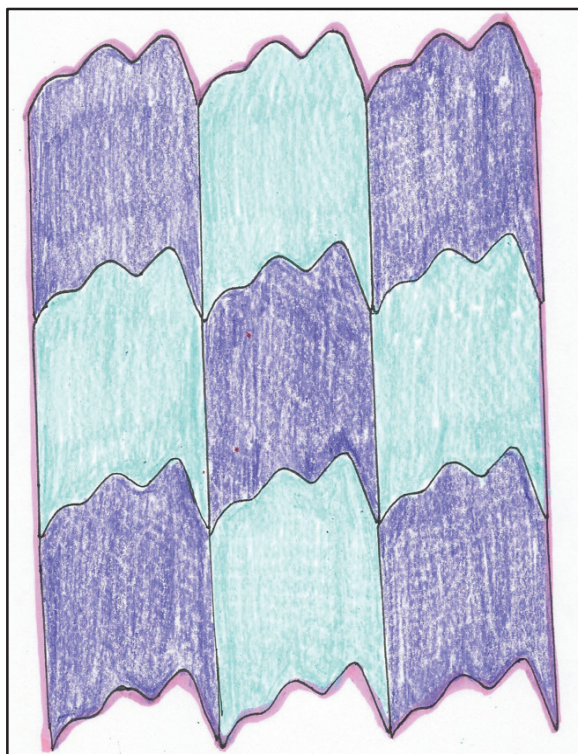



Name \_\_\_\_\_

Date \_\_\_\_\_

Estimate to draw at least four copies of the given regular hexagon to make a new shape, without gaps or overlaps. Outline the perimeter of your new shape with a highlighter. Shade in the area with a colored pencil.

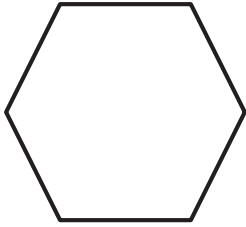

Name \_\_\_\_\_

Date \_\_\_\_\_

1. Samson tessellates regular hexagons to make the shape below.

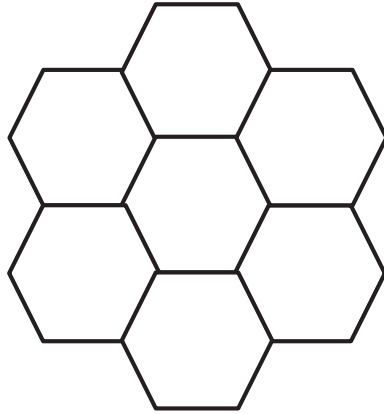

- Outline the perimeter of Samson's new shape with a highlighter.
  - Explain how Samson could use a string to measure the perimeter of his new shape.
  - How many sides does his new shape have?
  - Shade in the area of his new shape with a colored pencil.
2. Estimate to draw at least four copies of the given triangle to make a new shape, without gaps or overlaps. Outline the perimeter of your new shape with a highlighter. Shade in the area with a colored pencil.

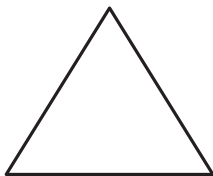

3. The marks on the strings below show the perimeters of Shyla's and Frank's shapes. Whose shape has a greater perimeter? How do you know?

Shyla's String: 

Frank's String: 

4. India and Theo use the same shape to create the tessellations shown below.

India's Tessellation

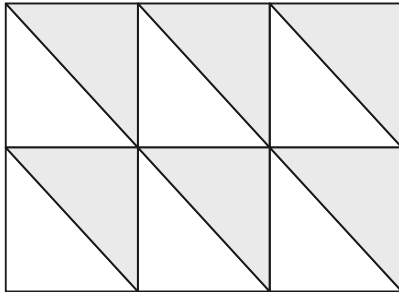

Theo's Tessellation

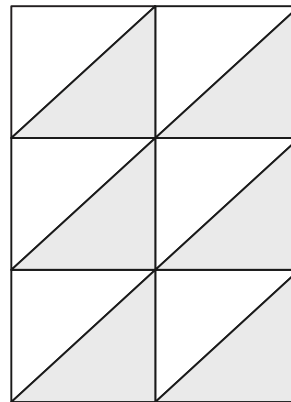

- a. Estimate to draw the shape India and Theo used to make their tessellations.
- b. Theo says both tessellations have the same perimeter. Do you think Theo is right? Why or why not?

## Lesson 12

**Objective:** Measure side lengths in whole number units to determine the perimeter of polygons.

### Suggested Lesson Structure

■ Fluency Practice	(15 minutes)
■ Concept Development	(20 minutes)
■ Application Problem	(15 minutes)
■ Student Debrief	(10 minutes)
<b>Total Time</b>	<b>(60 minutes)</b>

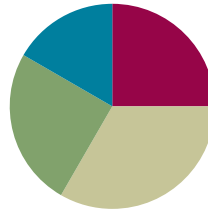

#### NOTES ON LESSON SEQUENCE:

In this lesson, the Application Problem comes after the Concept Development and before independent work time on the Problem Set. This provides students with an opportunity to apply their learning from the Concept Development to a word problem and debrief it as a class before moving on to independent application on the Problem Set. As a result, the 15 minutes for the Application Problem include 10 minutes for the Problem Set.

### Fluency Practice (15 minutes)

- Multiply by 7 **3.OA.7** (8 minutes)
- Equivalent Counting with Units of 3 **3.OA.7** (4 minutes)
- Area and Perimeter **3.G.2** (3 minutes)

### Multiply by 7 (8 minutes)

Materials: (S) Multiply by 7 (6–10) Pattern Sheet

Note: This activity builds fluency with multiplication facts using units of 7. It works toward students knowing from memory all the products of two one-digit numbers. See Lesson 1 for the directions for administration of a Multiply-By Pattern Sheet.

T: (Write  $7 \times 7 = \underline{\quad}$ .) Let's skip-count up by sevens. I'll raise a finger for each seven. (Raise a finger for each number to track the count.)

S: 7, 14, 21, 28, 35, 42, 49.

T: Let's skip-count up by sevens starting at 35. Why is 35 a good place to start?

S: It's a fact we already know, so we can use it to figure out a fact we don't know.

T: (Track with fingers as students say the numbers.)

S: 35 (5 fingers), 42 (6 fingers), 49 (7 fingers).

T: Let's see how we can skip-count down to find the answer, too. Start at 70 with 10 fingers, 1 for each seven. (Count down with fingers as students say the numbers.)

S: 70 (10 fingers), 63 (9 fingers), 56 (8 fingers), 49 (7 fingers).

Continue with the following possible sequence:  $9 \times 7$ ,  $6 \times 7$ , and  $8 \times 7$ .

T: (Distribute the Multiply by 7 Pattern Sheet.) Let's practice multiplying by 7. Be sure to work left to right across the page.

### Equivalent Counting with Units of 3 (4 minutes)

Note: This activity builds fluency with multiplication facts using units of 3.

T: Count by threes to 30. (Write as students count.)

S: 3, 6, 9, 12, 15, 18, 21, 24, 27, 30.

3	6	9	12	15	18	21	24	27	30
1 three	2 threes	3 threes	4 threes	5 threes	6 threes	7 threes	8 threes	9 threes	10 threes

T: (Write 1 three beneath the 3.) Count to 10 threes. (Write as students count.)

S: 1 three, 2 threes, 3 threes, 4 threes, 5 threes, 6 threes, 7 threes, 8 threes, 9 threes, 10 threes.

T: Let's count to 10 threes again. This time, stop when I raise my hand.

S: 1 three, 2 threes, 3 threes.

T: (Raise hand.) Say the multiplication sentence.

S:  $3 \times 3 = 9$ .

T: Continue.

S: 4 threes, 5 threes.

T: (Raise hand.) Say the multiplication sentence.

S:  $5 \times 3 = 15$ .

Continue the process up to 10 threes and down to 1 three.

### Area and Perimeter (3 minutes)

Materials: (S) Grid paper

Note: This activity reviews Lesson 10.

T: On your grid paper, shade a rectangle that is 2 units wide by 3 units long.

S: (Shade a 2 unit by 3 unit rectangle.)

T: What is the area of the rectangle?

S: 6 square units!

T: Draw a line around the perimeter of the rectangle.

S: (Draw line around the perimeter.)

T: At the signal, show your paper. (Signal.)

S: (Show paper with the perimeter marked.)

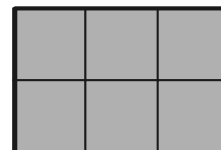

Continue with the following possible sequence: 4 units by 2 units and 5 units by 3 units.

### Concept Development (20 minutes)

Materials: (S) Personal white board, shapes (Template) (pictured below), ruler

T: (Pass out the Template.) Yesterday you learned that the boundary of a shape is the shape’s perimeter. What forms the boundary of Shape A? Talk to a partner.

S: The outside edges of the shape. → The sides of the shape form the boundary.

T: The sides form the boundary of Shape A. Trace the perimeter of Shape A with your finger. (Allow students time to trace.) Your finger just traveled around the perimeter of Shape A. What tool can you use to figure out how many centimeters your finger traveled?

S: A ruler!

T: Measure and label the side lengths of Shape A in centimeters. (Allow students time to work, and then project Shape A with the side lengths labeled.) Check your side lengths against mine. Write and solve a number sentence to show how to find the total of Shape A’s side lengths.

S: (Possible number sentences include the following:  
 $10 + 10 + 4 + 4 = 28$ . →  $(2 \times 10) + (2 \times 4) = 20 + 8 = 28$ .  
 →  $(10 + 4) \times 2 = 28$ .)

T: What strategy did you use to find the total of the side lengths?

S: I doubled 10 to get 20 and doubled 4 to get 8. Then, I added 20 and 8 to get 28. → That’s like what I did. I thought of it as 2 tens plus 2 fours. → I added 10 and 4 to get 14. I knew there were 2 fourteens, so I doubled 14 to get 28.

T: What is 28 centimeters a measurement of?

S: The perimeter!

T: What kind of polygon is Shape A?

S: A quadrilateral because it has four sides.  
 → A parallelogram because it has two sets of parallel lines. → A rectangle because the opposite sides are equal and the corners look like right angles.

Repeat the process with Shapes B through E. Students measure the side lengths in centimeters, calculate the perimeter, discuss strategies for finding the total, and name each shape. When they are ready, release them to work independently or with a partner.



#### NOTES ON MULTIPLE MEANS OF REPRESENTATION:

When asking, “What forms the boundary of Shape A?” use gestures to convey the meaning clearly to English language learners. For example, while saying the word *boundary*, project or hold the shape, and trace its sides.

Shapes Template

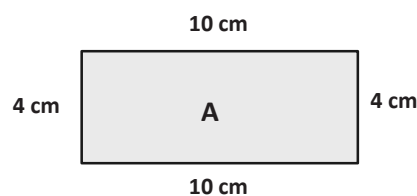
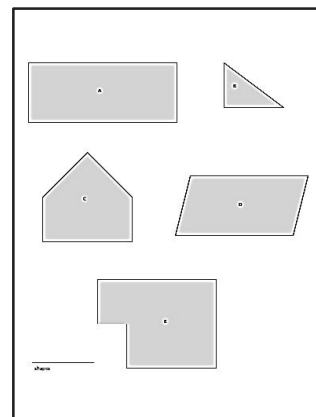

#### NOTES ON MULTIPLE MEANS OF REPRESENTATION:

Outlining the shapes on the Template with glue that dries and makes a hard boundary may be beneficial to some students as they measure, particularly students with low vision.

MP.5



### Application Problem (15 minutes)

Angela measures the sides of a square napkin with her ruler. Each side measures 6 inches. What is the perimeter of the napkin?

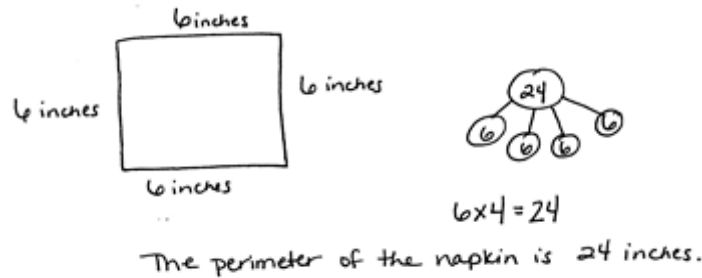

Note: This problem allows students to transfer their conceptual knowledge from the lesson to an Application Problem before practicing this independently with the remainder of the Problem Set.

### Problem Set (10 minutes)

Students should do their personal best to complete the Problem Set within the allotted 10 minutes. For some classes, it may be appropriate to modify the assignment by specifying which problems they work on first. Some problems do not specify a method for solving. Students should solve these problems using the RDW approach used for Application Problems.

### Student Debrief (10 minutes)

**Lesson Objective:** Measure side lengths in whole number units to determine the perimeter of polygons.

The Student Debrief is intended to invite reflection and active processing of the total lesson experience. Invite students to review their solutions for the Problem Set. They should check work by comparing answers with a partner before going over answers as a class. Look for misconceptions or misunderstandings that can be addressed in the Debrief. Guide students in a conversation to debrief the Problem Set and process the lesson.

Any combination of the questions below may be used to lead the discussion.

- Which shape has the smallest perimeter in Problem 1? How do you know?
- What unit did you use to record the perimeters of the shapes in Problem 1? Why?

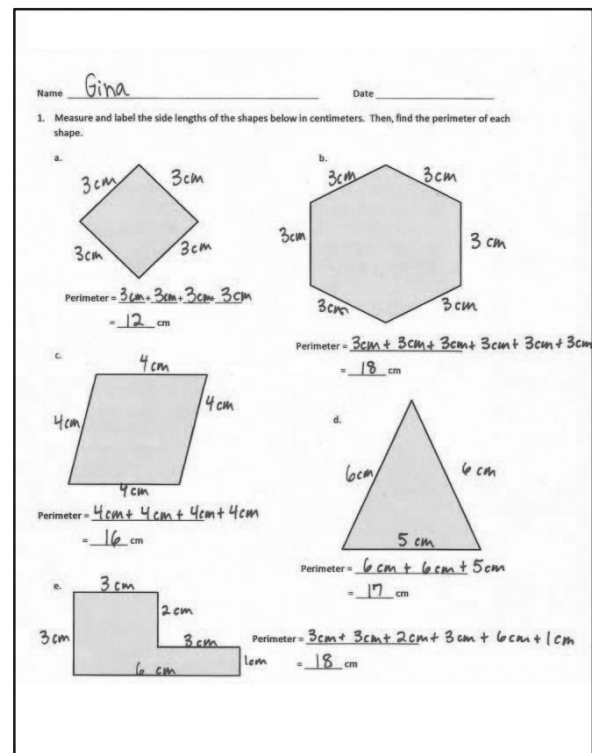

Name: Gina Date: \_\_\_\_\_

1. Measure and label the side lengths of the shapes below in centimeters. Then, find the perimeter of each shape.

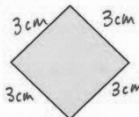
a.   
Perimeter =  $3\text{ cm} + 3\text{ cm} + 3\text{ cm} + 3\text{ cm}$   
= 12 cm

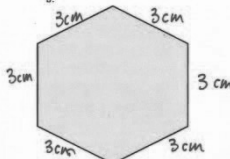
b.   
Perimeter =  $3\text{ cm} + 3\text{ cm} + 3\text{ cm} + 3\text{ cm} + 3\text{ cm} + 3\text{ cm}$   
= 18 cm

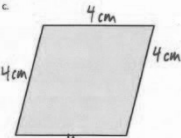
c.   
Perimeter =  $4\text{ cm} + 4\text{ cm} + 4\text{ cm} + 4\text{ cm}$   
= 16 cm

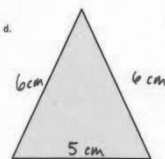
d.   
Perimeter =  $6\text{ cm} + 6\text{ cm} + 5\text{ cm}$   
= 17 cm

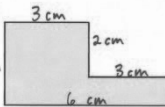
e.   
Perimeter =  $3\text{ cm} + 3\text{ cm} + 2\text{ cm} + 3\text{ cm} + 6\text{ cm} + 1\text{ cm}$   
= 18 cm

- What do you notice about the perimeters of the shapes in Problem 1 (b) and (e)?
- How did doing the Application Problem together help you get ready for the Problem Set?
- How could you find the perimeter of each triangle in Problem 2?
- Whose shape has more sides in Problem 3? Do more sides mean a greater perimeter? Why or why not?
- What multiplication equation can you use to find the perimeter of the square in Problem 4? (This anticipates the work done in Lesson 15 of finding the perimeter of a regular polygon given one side length.)
- Explain to a partner how to use a ruler to find the perimeter of a shape.

### Exit Ticket (3 minutes)

After the Student Debrief, instruct students to complete the Exit Ticket. A review of their work will help with assessing students' understanding of the concepts that were presented in today's lesson and planning more effectively for future lessons. The questions may be read aloud to the students.

2. Carson draws two triangles to create the new shape shown below. Use a ruler to find the side lengths of Carson's shape in centimeters. Then, find the perimeter.

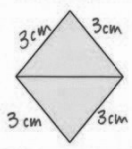

$$P = 3\text{ cm} + 3\text{ cm} + 3\text{ cm} + 3\text{ cm} = 12\text{ cm}$$

The perimeter of Carson's shape is 12 cm.

3. Hugh and Daisy draw the shapes shown below. Measure and label the side lengths in centimeters. Whose shape has a greater perimeter? How do you know?

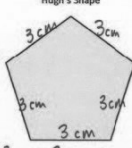
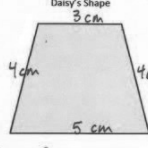
$$P = 3\text{ cm} + 4\text{ cm} + 4\text{ cm} + 5\text{ cm} = 16\text{ cm}$$

Daisy's shape has a greater perimeter. I measured the side lengths and added to find each perimeter. 16 is greater than 15.

4. Andrea measures one side length of the square below and says she can find the perimeter with that measurement. Explain Andrea's thinking. Then, find the perimeter in centimeters.

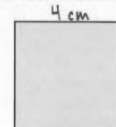

Andrea can find the perimeter by measuring one side length of the square because squares have 4 equal sides. If she measures one side, the rest of the sides are that length.

$$P = 4\text{ cm} + 4\text{ cm} + 4\text{ cm} + 4\text{ cm} = 16\text{ cm}$$

The perimeter is 16 cm.

Multiply.

$7 \times 1 = \underline{\quad}$      $7 \times 2 = \underline{\quad}$      $7 \times 3 = \underline{\quad}$      $7 \times 4 = \underline{\quad}$

$7 \times 5 = \underline{\quad}$      $7 \times 6 = \underline{\quad}$      $7 \times 7 = \underline{\quad}$      $7 \times 8 = \underline{\quad}$

$7 \times 9 = \underline{\quad}$      $7 \times 10 = \underline{\quad}$      $7 \times 5 = \underline{\quad}$      $7 \times 6 = \underline{\quad}$

$7 \times 5 = \underline{\quad}$      $7 \times 7 = \underline{\quad}$      $7 \times 5 = \underline{\quad}$      $7 \times 8 = \underline{\quad}$

$7 \times 5 = \underline{\quad}$      $7 \times 9 = \underline{\quad}$      $7 \times 5 = \underline{\quad}$      $7 \times 10 = \underline{\quad}$

$7 \times 6 = \underline{\quad}$      $7 \times 5 = \underline{\quad}$      $7 \times 6 = \underline{\quad}$      $7 \times 7 = \underline{\quad}$

$7 \times 6 = \underline{\quad}$      $7 \times 8 = \underline{\quad}$      $7 \times 6 = \underline{\quad}$      $7 \times 9 = \underline{\quad}$

$7 \times 6 = \underline{\quad}$      $7 \times 7 = \underline{\quad}$      $7 \times 6 = \underline{\quad}$      $7 \times 7 = \underline{\quad}$

$7 \times 8 = \underline{\quad}$      $7 \times 7 = \underline{\quad}$      $7 \times 9 = \underline{\quad}$      $7 \times 7 = \underline{\quad}$

$7 \times 8 = \underline{\quad}$      $7 \times 6 = \underline{\quad}$      $7 \times 8 = \underline{\quad}$      $7 \times 7 = \underline{\quad}$

$7 \times 8 = \underline{\quad}$      $7 \times 9 = \underline{\quad}$      $7 \times 9 = \underline{\quad}$      $7 \times 6 = \underline{\quad}$

$7 \times 9 = \underline{\quad}$      $7 \times 7 = \underline{\quad}$      $7 \times 9 = \underline{\quad}$      $7 \times 8 = \underline{\quad}$

$7 \times 9 = \underline{\quad}$      $7 \times 8 = \underline{\quad}$      $7 \times 6 = \underline{\quad}$      $7 \times 9 = \underline{\quad}$

$7 \times 7 = \underline{\quad}$      $7 \times 9 = \underline{\quad}$      $7 \times 6 = \underline{\quad}$      $7 \times 8 = \underline{\quad}$

$7 \times 9 = \underline{\quad}$      $7 \times 7 = \underline{\quad}$      $7 \times 6 = \underline{\quad}$      $7 \times 8 = \underline{\quad}$

multiply by 7 (6–10)

Name \_\_\_\_\_

Date \_\_\_\_\_

1. Measure and label the side lengths of the shapes below in centimeters. Then, find the perimeter of each shape.

a.

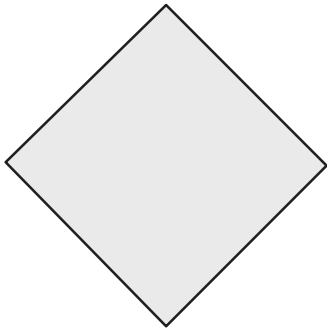

$$\begin{aligned} \text{Perimeter} &= \underline{\quad} \text{ cm} + \underline{\quad} \text{ cm} + \underline{\quad} \text{ cm} + \underline{\quad} \text{ cm} \\ &= \underline{\quad} \text{ cm} \end{aligned}$$

b.

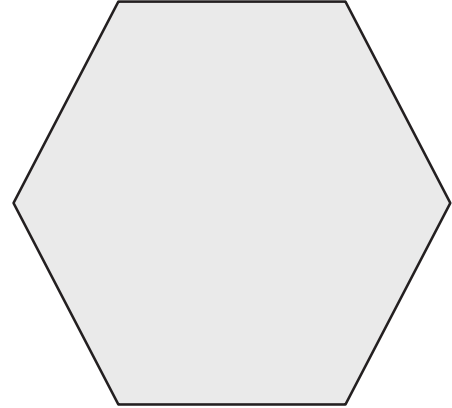

$$\begin{aligned} \text{Perimeter} &= \underline{\hspace{2cm}} \\ &= \underline{\quad} \text{ cm} \end{aligned}$$

c.

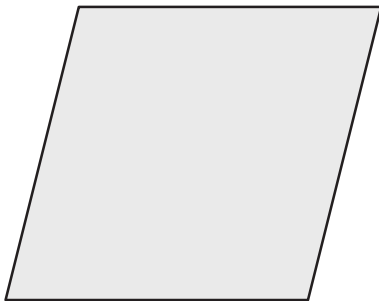

$$\begin{aligned} \text{Perimeter} &= \underline{\hspace{2cm}} \\ &= \underline{\quad} \text{ cm} \end{aligned}$$

d.

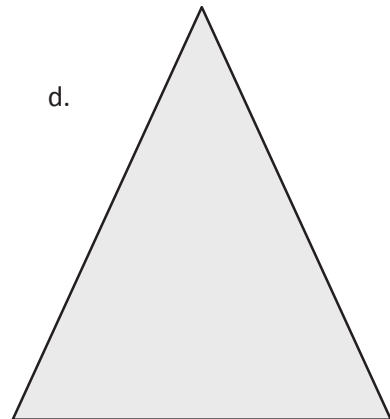

$$\begin{aligned} \text{Perimeter} &= \underline{\hspace{2cm}} \\ &= \underline{\quad} \text{ cm} \end{aligned}$$

e.

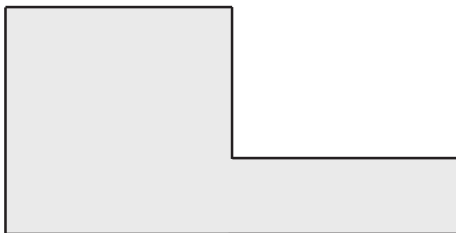

$$\begin{aligned} \text{Perimeter} &= \underline{\hspace{2cm}} \\ &= \underline{\quad} \text{ cm} \end{aligned}$$

2. Carson draws two triangles to create the new shape shown below. Use a ruler to find the side lengths of Carson's shape in centimeters. Then, find the perimeter.

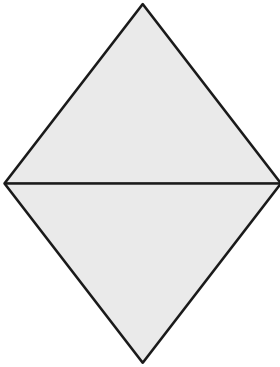

3. Hugh and Daisy draw the shapes shown below. Measure and label the side lengths in centimeters. Whose shape has a greater perimeter? How do you know?

**Hugh's Shape**

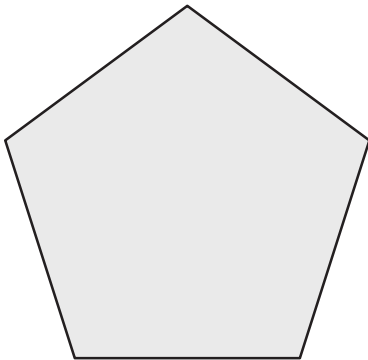

**Daisy's Shape**

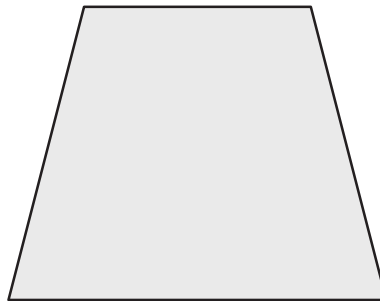

4. Andrea measures one side length of the square below and says she can find the perimeter with that measurement. Explain Andrea's thinking. Then, find the perimeter in centimeters.



Name \_\_\_\_\_

Date \_\_\_\_\_

Measure and label the side lengths of the shape below in centimeters. Then, find the perimeter.

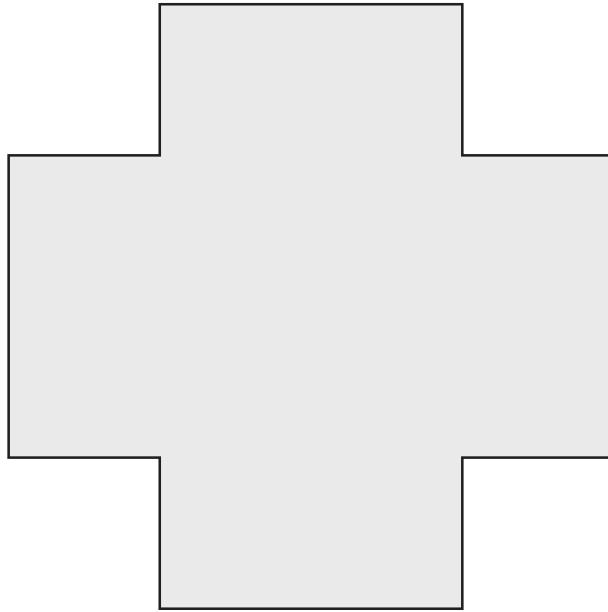

Perimeter = \_\_\_\_\_

= \_\_\_\_\_ cm

Name \_\_\_\_\_

Date \_\_\_\_\_

1. Measure and label the side lengths of the shapes below in centimeters. Then, find the perimeter of each shape.

a.

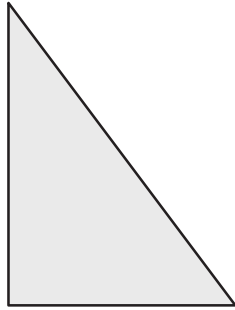

Perimeter = \_\_\_\_\_ cm + \_\_\_\_\_ cm + \_\_\_\_\_ cm  
= \_\_\_\_\_ cm

b.



Perimeter = \_\_\_\_\_  
= \_\_\_\_\_ cm

c.

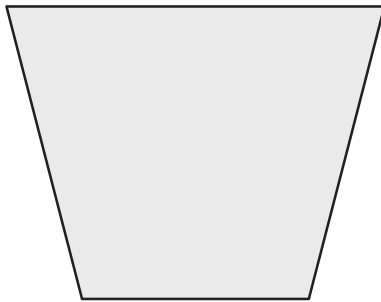

Perimeter = \_\_\_\_\_  
= \_\_\_\_\_ cm

d.

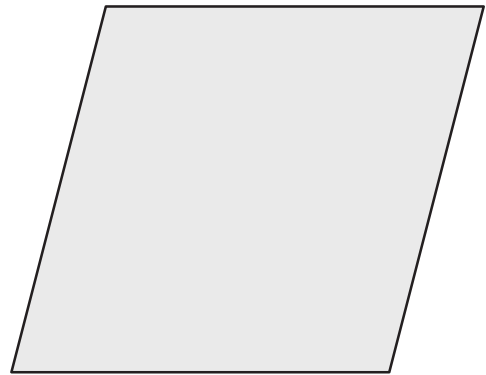

Perimeter = \_\_\_\_\_  
= \_\_\_\_\_ cm

e.

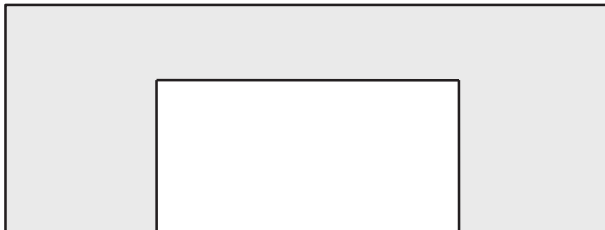

Perimeter = \_\_\_\_\_  
= \_\_\_\_\_ cm

2. Melinda draws two trapezoids to create the hexagon shown below. Use a ruler to find the side lengths of Melinda's hexagon in centimeters. Then, find the perimeter.

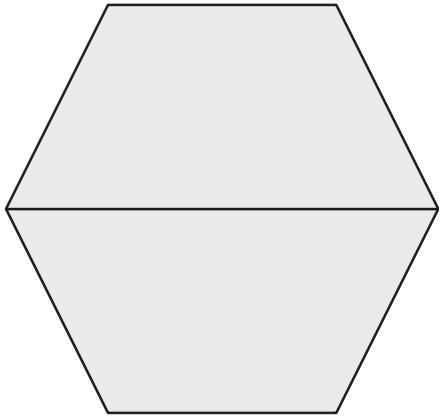

3. Victoria and Eric draw the shapes shown below. Eric says his shape has a greater perimeter because it has more sides than Victoria's shape. Is Eric right? Explain your answer.

Victoria's Shape

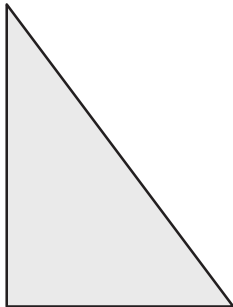

Eric's Shape



4. Jamal uses his ruler and a right angle tool to draw the rectangle shown below. He says the perimeter of his rectangle is 32 centimeters. Do you agree with Jamal? Why or why not?

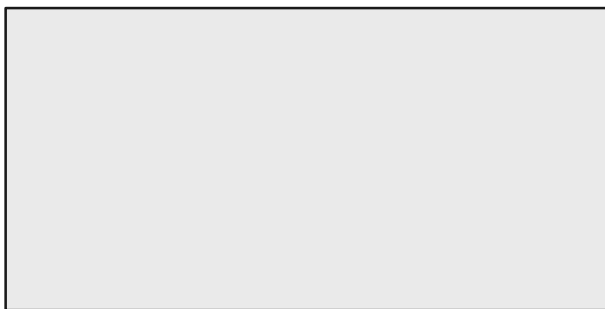



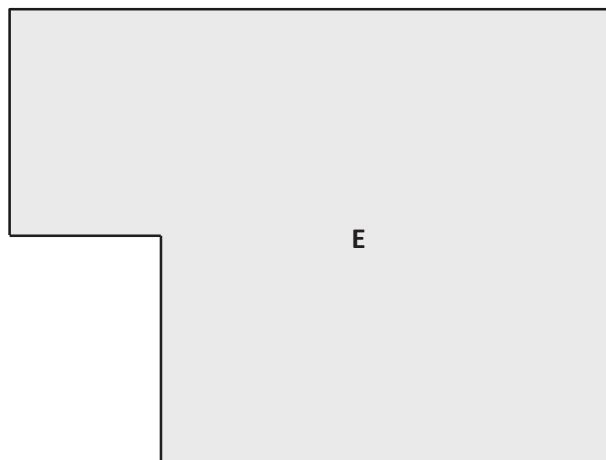
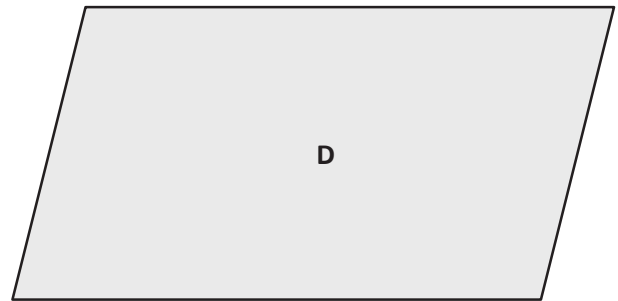
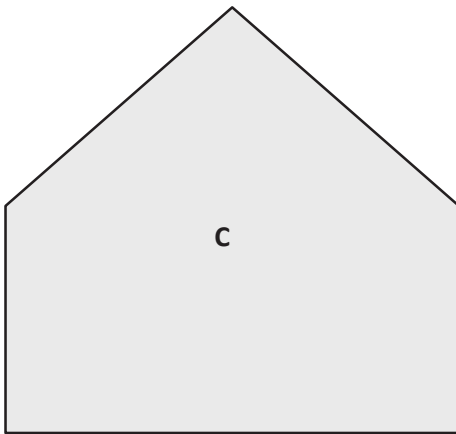
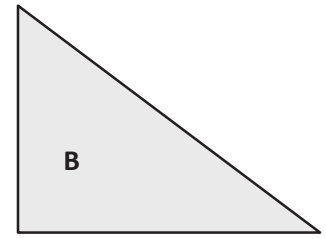
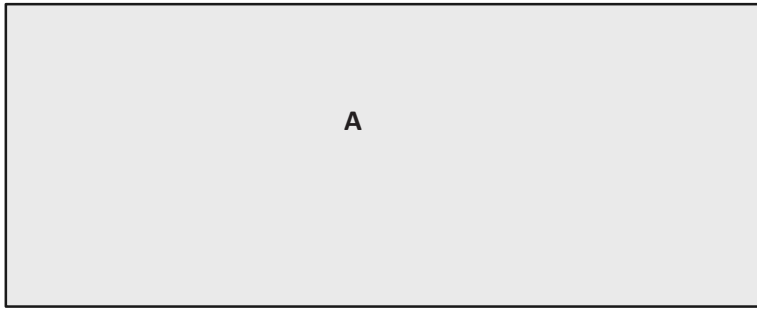

---

shapes

## Lesson 13

**Objective:** Explore perimeter as an attribute of plane figures and solve problems.

### Suggested Lesson Structure

■ Fluency Practice	(16 minutes)
■ Application Problem	(8 minutes)
■ Concept Development	(26 minutes)
■ Student Debrief	(10 minutes)
<b>Total Time</b>	<b>(60 minutes)</b>

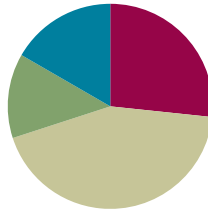

### Fluency Practice (16 minutes)

- Multiply by 8 **3.OA.7** (8 minutes)
- Equivalent Counting with Units of 4 **3.OA.7** (4 minutes)
- Find the Perimeter **3.MD.8** (4 minutes)

### Multiply by 8 (8 minutes)

Materials: (S) Multiply by 8 (1–5) Pattern Sheet

Note: This activity builds fluency with multiplication facts using units of 8. It works toward students knowing from memory all the products of two one-digit numbers. See Lesson 1 for the directions for administration of a Multiply-By Pattern Sheet.

T: (Write  $5 \times 8 = \underline{\quad}$ .) Let's skip-count up by eights to find the answer. (Raise a finger for each number to track the count. Record the skip-count answers on the board.)

S: 8, 16, 24, 32, 40.

T: (Circle 40, and write  $5 \times 8 = 40$  above it. Write  $3 \times 8 = \underline{\quad}$ .) Let's skip-count up by eights again. (Track with fingers as students count.)

S: 8, 16, 24.

T: Let's see how we can skip-count down to find the answer, too. Start at 40 with 5 fingers, 1 for each eight. (Count down with fingers as students say the numbers.)

S: 40 (five fingers), 32 (4 fingers), 24 (3 fingers).

Repeat the process for  $4 \times 8$ .

T: (Distribute the Multiply by 8 Pattern Sheet.) Let's practice multiplying by 8. Be sure to work left to right across the page.

### Equivalent Counting with Units of 4 (4 minutes)

Note: This activity builds fluency with multiplication facts using units of 4.

T: Count by fours to 40. (Write as students count.)

S: 4, 8, 12, 16, 20, 24, 28, 32, 36, 40.

T: (Write 1 four beneath the 4.) Count to 10 fours. (Write as students count.)

4	8	12	16	20	24	28	32	36	40
1 four	2 fours	3 fours	4 fours	5 fours	6 fours	7 fours	8 fours	9 fours	10 fours

S: 1 four, 2 fours, 3 fours, 4 fours, 5 fours, 6 fours, 7 fours, 8 fours, 9 fours, 10 fours.

T: Let's count to 10 fours again. This time, stop when I raise my hand.

S: 1 four, 2 fours, 3 fours.

T: (Raise hand.) Say the multiplication sentence.

S:  $3 \times 4 = 12$ .

T: Continue.

S: 4 fours, 5 fours.

T: (Raise hand.) Say the multiplication sentence.

S:  $5 \times 4 = 20$ .

T: Continue the process up to 10 fours and down to 1 four.

### Find the Perimeter (4 minutes)

Materials: (S) Personal white board

Note: This activity reviews Lesson 11.

T: (Project 5 cm by 2 cm rectangle. Write  $P = \underline{\hspace{1cm}} \text{ cm} + \underline{\hspace{1cm}} \text{ cm} + \underline{\hspace{1cm}} \text{ cm} + \underline{\hspace{1cm}} \text{ cm}$ .) Copy the equation on your personal white board, and fill in the blanks.

S: (Write  $P = 5 \text{ cm} + 2 \text{ cm} + 5 \text{ cm} + 2 \text{ cm}$ .)

T: (Write  $P = \underline{\hspace{1cm}} \text{ cm}$ .) Solve your equation to find the perimeter.

S: (Write  $P = 14 \text{ cm}$ .)

Continue the process with the other polygons.

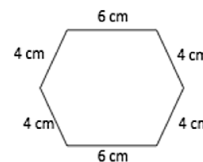
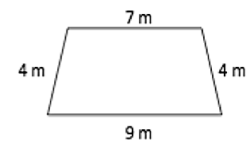
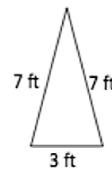
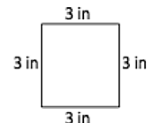
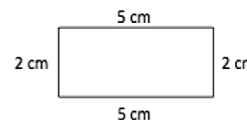

### Application Problem (8 minutes)

Materials: (S) 3" × 5" index card, ruler

Use your index card to answer the questions.

- What is the perimeter of your index card in inches?
- Place the short end of your index card next to the short end of your partner's index card. Make a prediction: What do you think the perimeter is of the new shape you made?
- Find the perimeter of the new shape. Was your prediction right? Why or why not?

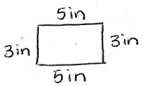
a.   $P = 5 + 5 + 3 + 3$   
 $P = 16$   
 The perimeter of the index card is 16 inches.

b. I think the perimeter of the new shape is double the perimeter of 1 index card.  
 $P = 2 \times 16$   
 $P = 16 + 16$   
 $P = 32$

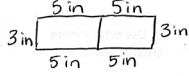
c.   $P = 5 + 5 + 5 + 5 + 3 + 3$   
 $P = 26$   
 The perimeter of the new shape is 26 inches. No, my prediction was wrong. I was off by 6 inches.

Note: This problem reviews Lesson 11's concept of measuring side lengths to calculate perimeter. Discuss the predictions that students made in part (b), and clear up any misconceptions about the perimeter of the new shape being double the perimeter of one index card.

### Concept Development (26 minutes)

Materials: (S) Personal white board

#### Part 1: Calculate perimeter with given side lengths.

T: (Project the shape to the right.) How can you use the information in this picture to find the perimeter of the shape? Talk to a partner.

S: I can just add the side lengths! → Side lengths are given, so I can add them to find the perimeter.

T: Write and solve an equation that shows the perimeter as the sum of the given side lengths.

S: (Write  $3 \text{ in} + 3 \text{ in} + 4 \text{ in} + 4 \text{ in} + 2 \text{ in} = 16 \text{ inches.}$ )

T: Talk to a partner. What strategy did you use to solve?

S: I added the fours to get 8.  $8 + 2 = 10$ . Then, I added 2 threes to 10 to get 16. → I doubled 3 to get 6 and then added a 4 to make 10. Then, I added 4 plus 2 plus 10 to get 16. → I added 3 plus 4 to get 7. Then, I doubled 7 to get 14 and added 2 to 14 to get 16. → I did 4 times 4 by just using the two to change the threes to fours.

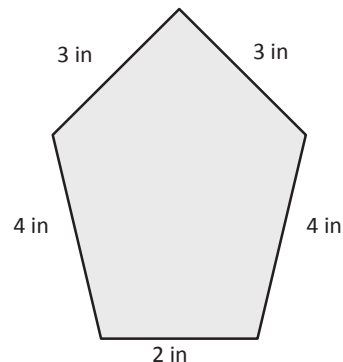

Repeat the process with the following possible suggestions.

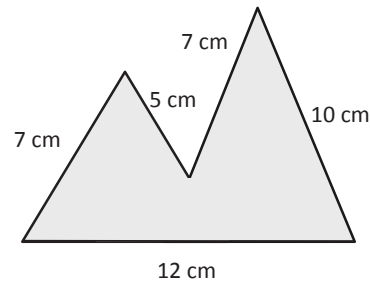
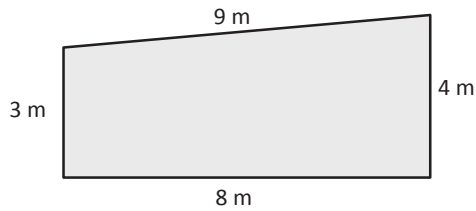

## Part 2: Practice calculating the perimeter of various shapes with given side lengths.

Materials: (T) Timer (S) Quiz-Quiz-Trade cards (Template) (pictured to the right), personal white board

Students play Quiz-Quiz-Trade, applying what they learned in Part 1 to calculate the perimeters of various shapes using either mental math or their personal white boards.

Directions for Quiz-Quiz-Trade:

1. Each person gets 1 Quiz-Quiz-Trade card.
2. Calculate the perimeter of the shape on the card.
3. Quiz-Quiz: Ask a partner to calculate the perimeter of the shape on your card while you calculate the perimeter of the shape on your partner's card. Try again if your answers for the same shape differ.
4. Trade: When both partners agree on the perimeters, trade cards, and repeat Step 3 with a new partner.

Prepare students by doing the following:

- Review strategies students can use to graciously verify the correctness of a calculation.
- Increase accountability and pace by setting a minimum number of trades to be made within a given time.
- Add a competitive element by giving students a point each time they correctly compute a perimeter.

### Quiz-Quiz-Trade Cards Template

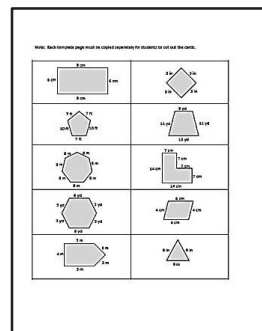
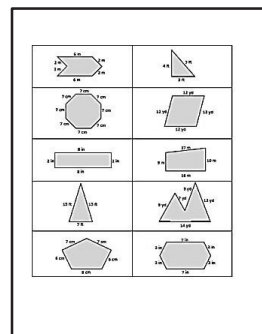

### NOTES ON MULTIPLE MEANS OF ENGAGEMENT:

Consider adjusting the numbers to better suit students working below grade level in order for them to experience success. It may, however, be more effective to limit the number of cards students below grade level play, so they may develop speed through repetition.

### Problem Set (10 minutes)

Students should do their personal best to complete the Problem Set within the allotted 10 minutes. For some classes, it may be appropriate to modify the assignment by specifying which problems they work on first. Some problems do not specify a method for solving. Students should solve these problems using the RDW approach used for Application Problems.

### Student Debrief (10 minutes)

**Lesson Objective:** Explore perimeter as an attribute of plane figures and solve problems.

The Student Debrief is intended to invite reflection and active processing of the total lesson experience. Invite students to review their solutions for the Problem Set. They should check work by comparing answers with a partner before going over answers as a class. Look for misconceptions or misunderstandings that can be addressed in the Debrief. Guide students in a conversation to debrief the Problem Set and process the lesson.

Any combination of the questions below may be used to lead the discussion.

- Tell a partner the names of the shapes in Problem 1. Be as specific as possible. What information helped you name each shape?
- What multiplication sentence can you use to find the perimeter of the shape in Problem 1(b)? (This anticipates the work done in Lesson 15 of finding the perimeter of a regular polygon given one side length.)
- Can you think of the perimeter in Problem 2 as 4 tens plus 2 sixes? Why or why not?
- Compare the strategy you used to find the perimeter in Problem 3(a) to a partner's. How are your strategies similar? How are they different?
- Share your answer to Problem 3(b) with a partner.

Name Gina Date \_\_\_\_\_

1. Find the perimeter of the following shapes.

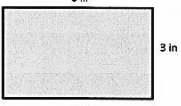
a.  
$$P = 3 \text{ in} + 3 \text{ in} + 3 \text{ in} + 8 \text{ in}$$

$$= 22 \text{ in}$$

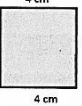
b.  
$$P = 4 \text{ cm} + 4 \text{ cm} + 4 \text{ cm} + 4 \text{ cm}$$

$$= 16 \text{ cm}$$

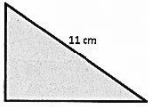
c.  
$$P = 11 \text{ cm} + 9 \text{ cm} + 6 \text{ cm}$$

$$= 26 \text{ cm}$$

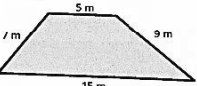
d.  
$$P = 15 \text{ m} + 5 \text{ m} + 9 \text{ m} + 7 \text{ m}$$

$$= 36 \text{ m}$$

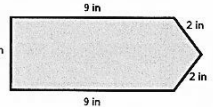
e.  
$$P = 9 \text{ in} + 9 \text{ in} + 2 \text{ in} + 2 \text{ in} + 3 \text{ in}$$

$$= 25 \text{ in}$$

2. Alan's rectangular swimming pool is 10 meters long and 16 meters wide. What is the perimeter?

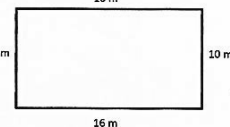
 
$$P = 16 \text{ m} + 16 \text{ m} + 10 \text{ m} + 10 \text{ m}$$

$$= 32 \text{ m} + 20 \text{ m}$$

$$= 52 \text{ m}$$
The perimeter of the pool is 52 m.

3. Lila measures each side of the shape below.

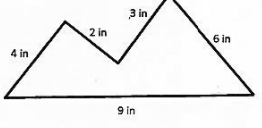
 
$$P = 4 \text{ in} + 6 \text{ in} + 2 \text{ in} + 3 \text{ in} + 9 \text{ in}$$

$$= 10 \text{ in} + 5 \text{ in} + 9 \text{ in}$$

$$= 15 \text{ in} + 9 \text{ in}$$

$$= 24 \text{ in}$$
The perimeter of the shape is 24 inches.

a. What is the perimeter of the shape?

b. Lila says the shape is a pentagon. Is she correct? Explain why or why not.

Yes, Lila is correct. The shape is a pentagon because it has 5 sides.

**Exit Ticket (3 minutes)**

After the Student Debrief, instruct students to complete the Exit Ticket. A review of their work will help with assessing students' understanding of the concepts that were presented in today's lesson and planning more effectively for future lessons. The questions may be read aloud to the students.

Multiply.

$8 \times 1 = \underline{\quad}$      $8 \times 2 = \underline{\quad}$      $8 \times 3 = \underline{\quad}$      $8 \times 4 = \underline{\quad}$

$8 \times 5 = \underline{\quad}$      $8 \times 1 = \underline{\quad}$      $8 \times 2 = \underline{\quad}$      $8 \times 1 = \underline{\quad}$

$8 \times 3 = \underline{\quad}$      $8 \times 1 = \underline{\quad}$      $8 \times 4 = \underline{\quad}$      $8 \times 1 = \underline{\quad}$

$8 \times 5 = \underline{\quad}$      $8 \times 1 = \underline{\quad}$      $8 \times 2 = \underline{\quad}$      $8 \times 3 = \underline{\quad}$

$8 \times 2 = \underline{\quad}$      $8 \times 4 = \underline{\quad}$      $8 \times 2 = \underline{\quad}$      $8 \times 5 = \underline{\quad}$

$8 \times 2 = \underline{\quad}$      $8 \times 1 = \underline{\quad}$      $8 \times 2 = \underline{\quad}$      $8 \times 3 = \underline{\quad}$

$8 \times 1 = \underline{\quad}$      $8 \times 3 = \underline{\quad}$      $8 \times 2 = \underline{\quad}$      $8 \times 3 = \underline{\quad}$

$8 \times 4 = \underline{\quad}$      $8 \times 3 = \underline{\quad}$      $8 \times 5 = \underline{\quad}$      $8 \times 3 = \underline{\quad}$

$8 \times 4 = \underline{\quad}$      $8 \times 1 = \underline{\quad}$      $8 \times 4 = \underline{\quad}$      $8 \times 2 = \underline{\quad}$

$8 \times 4 = \underline{\quad}$      $8 \times 3 = \underline{\quad}$      $8 \times 4 = \underline{\quad}$      $8 \times 5 = \underline{\quad}$

$8 \times 4 = \underline{\quad}$      $8 \times 5 = \underline{\quad}$      $8 \times 1 = \underline{\quad}$      $8 \times 5 = \underline{\quad}$

$8 \times 2 = \underline{\quad}$      $8 \times 5 = \underline{\quad}$      $8 \times 3 = \underline{\quad}$      $8 \times 5 = \underline{\quad}$

$8 \times 4 = \underline{\quad}$      $8 \times 2 = \underline{\quad}$      $8 \times 4 = \underline{\quad}$      $8 \times 3 = \underline{\quad}$

$8 \times 5 = \underline{\quad}$      $8 \times 3 = \underline{\quad}$      $8 \times 2 = \underline{\quad}$      $8 \times 4 = \underline{\quad}$

$8 \times 3 = \underline{\quad}$      $8 \times 5 = \underline{\quad}$      $8 \times 2 = \underline{\quad}$      $8 \times 4 = \underline{\quad}$

multiply by 8 (1–5)



Name \_\_\_\_\_

Date \_\_\_\_\_

1. Find the perimeter of the following shapes.

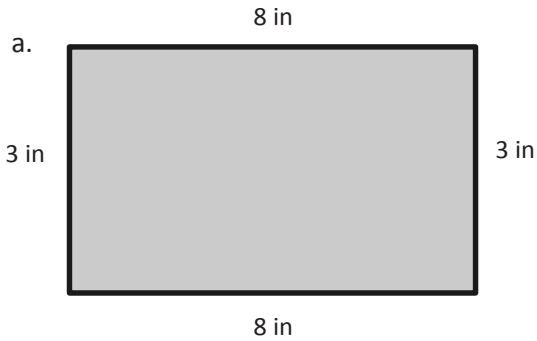

$$P = 3 \text{ in} + 8 \text{ in} + 3 \text{ in} + 8 \text{ in}$$

$$= \underline{\hspace{2cm}} \text{ in}$$

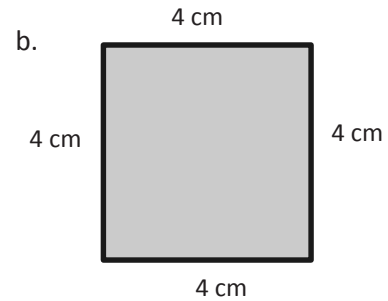

$$P = \underline{\hspace{1cm}} \text{ cm} + \underline{\hspace{1cm}} \text{ cm} + \underline{\hspace{1cm}} \text{ cm} + \underline{\hspace{1cm}} \text{ cm}$$

$$= \underline{\hspace{2cm}} \text{ cm}$$

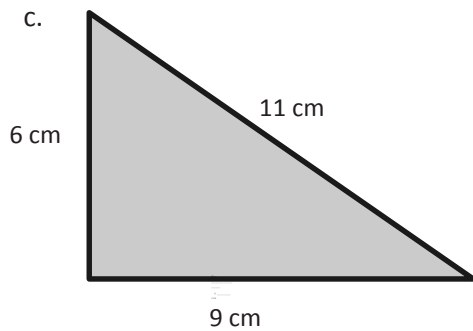

$$P = \underline{\hspace{1cm}} \text{ cm} + \underline{\hspace{1cm}} \text{ cm} + \underline{\hspace{1cm}} \text{ cm}$$

$$= \underline{\hspace{2cm}} \text{ cm}$$

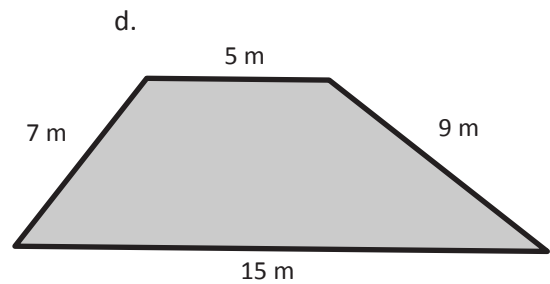

$$P = \underline{\hspace{1cm}} \text{ m} + \underline{\hspace{1cm}} \text{ m} + \underline{\hspace{1cm}} \text{ m} + \underline{\hspace{1cm}} \text{ m}$$

$$= \underline{\hspace{2cm}} \text{ m}$$

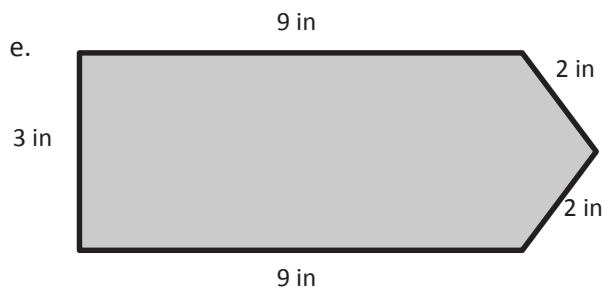

$$P = \underline{\hspace{1cm}} \text{ in} + \underline{\hspace{1cm}} \text{ in} + \underline{\hspace{1cm}} \text{ in} + \underline{\hspace{1cm}} \text{ in} + \underline{\hspace{1cm}} \text{ in}$$

$$= \underline{\hspace{2cm}} \text{ in}$$

2. Alan's rectangular swimming pool is 10 meters long and 16 meters wide. What is the perimeter?

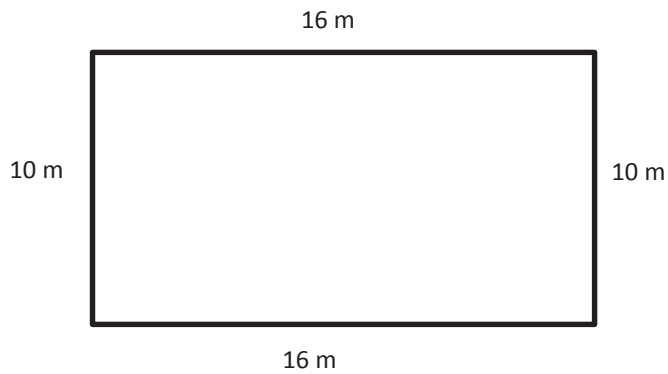

3. Lila measures each side of the shape below.

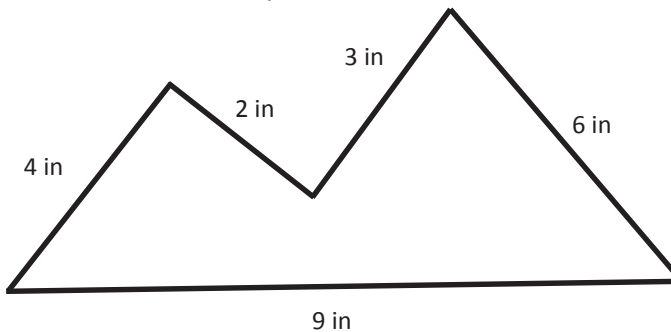

- a. What is the perimeter of the shape?
- b. Lila says the shape is a pentagon. Is she correct? Explain why or why not.

Name \_\_\_\_\_

Date \_\_\_\_\_

Which shape below has the greater perimeter? Explain your answer.

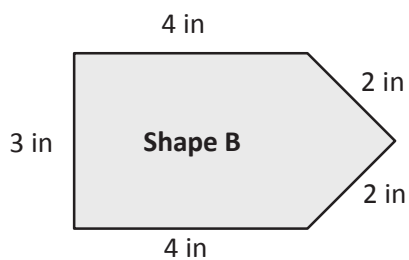
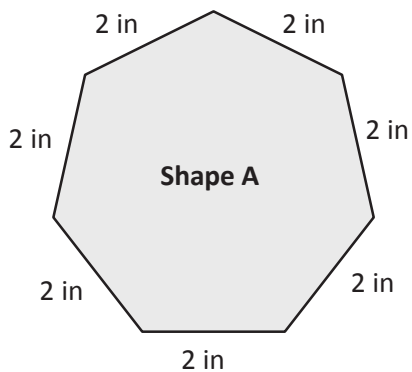

Name \_\_\_\_\_

Date \_\_\_\_\_

1. Find the perimeters of the shapes below. Include the units in your equations. Match the letter inside each shape to its perimeter to solve the riddle. The first one has been done for you.

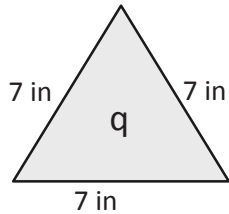

$$P = 7 \text{ in} + 7 \text{ in} + 7 \text{ in}$$

$$P = 21 \text{ in}$$

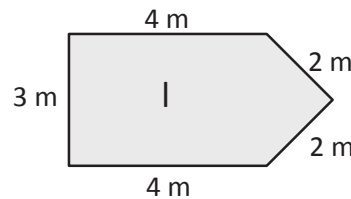
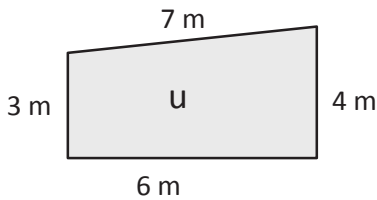
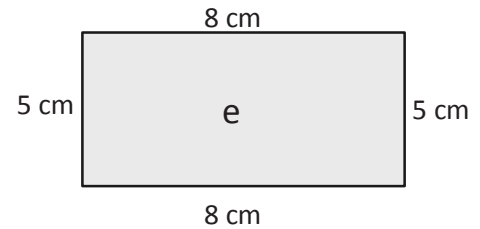
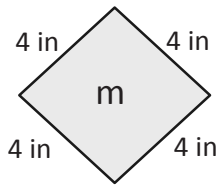
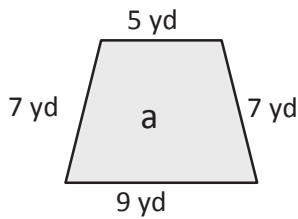
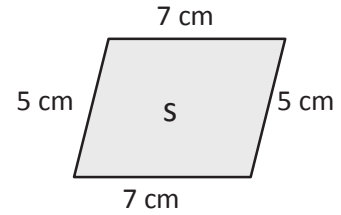
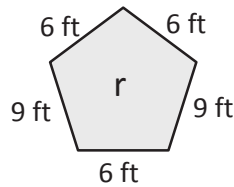

What kind of meals do math teachers eat?

\_\_\_\_\_ !  
 24    21    20    28    36    26    16    26    28    15    24



2. Alicia's rectangular garden is 33 feet long and 47 feet wide. What is the perimeter of Alicia's garden?

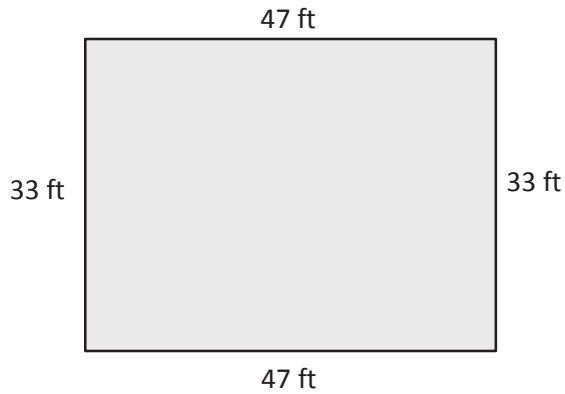

3. Jaques measured the side lengths of the shape below.

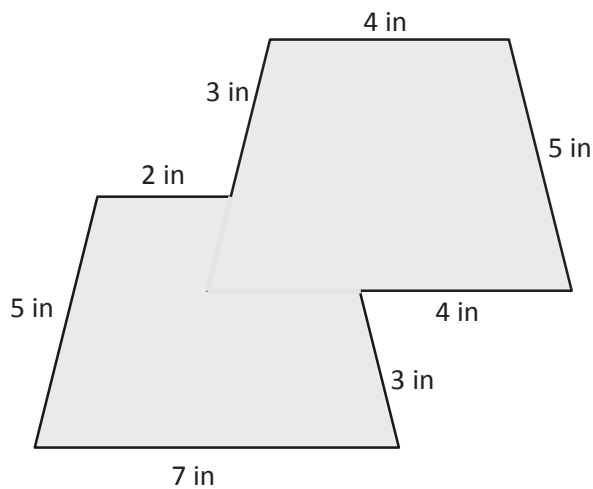

- a. Find the perimeter of Jaques's shape.
- b. Jaques says his shape is an octagon. Is he right? Why or why not?

Note: Each Template page must be copied separately for students to cut out the cards.

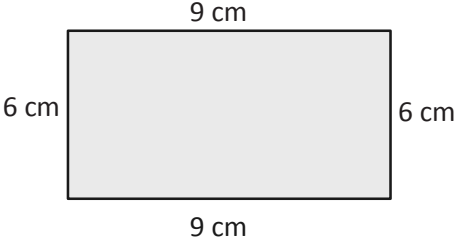
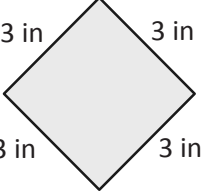
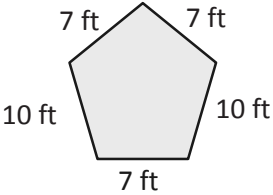
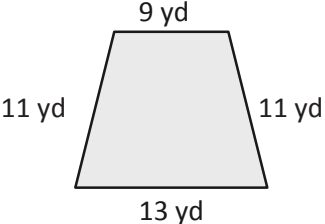
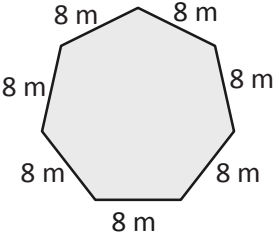
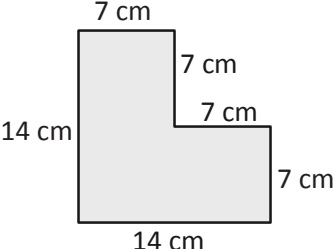
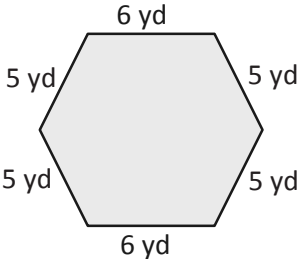
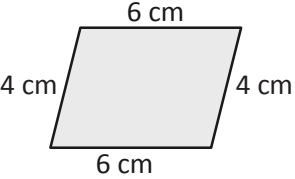
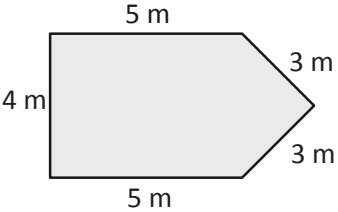
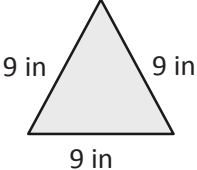
 <p>A rectangle with a top side of 9 cm, a bottom side of 9 cm, a left side of 6 cm, and a right side of 6 cm.</p>	 <p>A square rotated 45 degrees with all four sides labeled 3 in.</p>
 <p>A pentagon with a top-left side of 7 ft, a top-right side of 7 ft, a bottom-left side of 10 ft, a bottom-right side of 10 ft, and a bottom side of 7 ft.</p>	 <p>A trapezoid with a top base of 9 yd, a bottom base of 13 yd, and two slanted sides of 11 yd each.</p>
 <p>A regular heptagon with all seven sides labeled 8 m.</p>	 <p>An L-shaped polygon with a left vertical side of 14 cm, a top horizontal side of 7 cm, a right vertical side of 7 cm, a bottom horizontal side of 7 cm, a left vertical side of 7 cm, and a bottom horizontal side of 14 cm.</p>
 <p>A hexagon with a top side of 6 yd, a bottom side of 6 yd, and four slanted sides of 5 yd each.</p>	 <p>A parallelogram with a top side of 6 cm, a bottom side of 6 cm, a left side of 4 cm, and a right side of 4 cm.</p>
 <p>An irregular pentagon with a top horizontal side of 5 m, a left vertical side of 4 m, a bottom horizontal side of 5 m, and two slanted sides of 3 m each.</p>	 <p>An equilateral triangle with all three sides labeled 9 in.</p>

quiz-quiz-trade cards

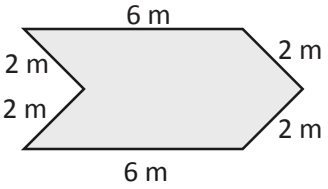
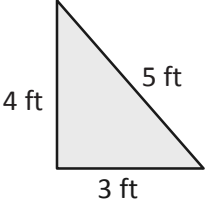
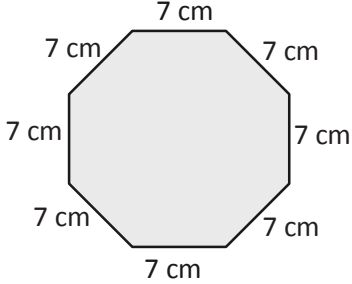
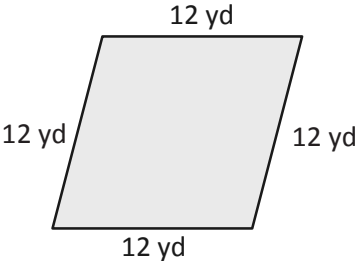
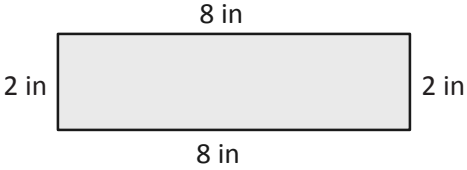
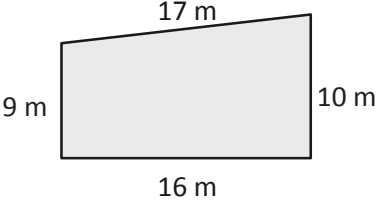
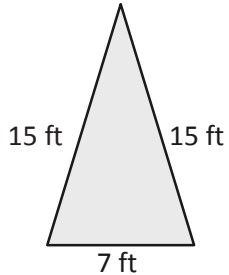
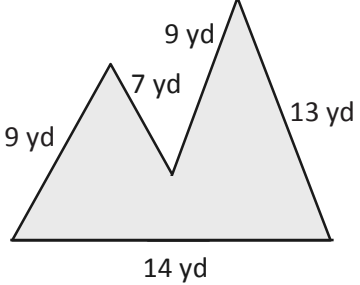
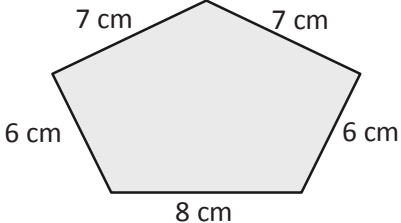
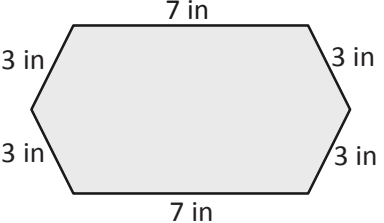
quiz-quiz-trade cards

## Lesson 14

**Objective:** Determine the perimeter of regular polygons and rectangles when whole number measurements are unknown.

### Suggested Lesson Structure

■ Fluency Practice	(12 minutes)
■ Application Problem	(5 minutes)
■ Concept Development	(33 minutes)
■ Student Debrief	(10 minutes)
<b>Total Time</b>	<b>(60 minutes)</b>

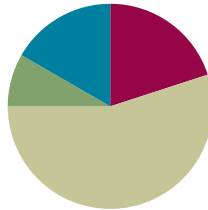

### Fluency Practice (12 minutes)

- Multiply by 8 **3.OA.7** (8 minutes)
- Equivalent Counting with Units of 7 **3.OA.7** (4 minutes)

### Multiply by 8 (8 minutes)

Materials: (S) Multiply by 8 (6–10) Pattern Sheet

Note: This activity builds fluency with multiplication facts using units of 8. It works toward students knowing from memory all the products of two one-digit numbers. See Lesson 1 for the directions for administration of a Multiply-By Pattern Sheet.

T: (Write  $7 \times 8 = \underline{\quad}$ .) Let's skip-count up by eights. I'll raise a finger for each eight. (Raise a finger for each number to track the count.)

S: 8, 16, 24, 32, 40, 48, 56.

T: Let's skip-count up by eights starting at 40. Why is 40 a good place to start?

S: It's a fact we already know, so we can use it to figure out a fact we don't know.

T: (Track with fingers as students say the numbers.)

S: 40 (5 fingers), 48 (6 fingers), 56 (7 fingers).

T: Let's see how we can skip-count down to find the answer, too. Start at 80 with 10 fingers, 1 for each eight. (Count down with fingers as students say the numbers.)

S: 80 (10 fingers), 72 (9 fingers), 64 (8 fingers), 56 (7 fingers).

Continue with the following possible sequence:  $9 \times 8$ ,  $6 \times 8$ , and  $8 \times 8$ .

T: (Distribute the Multiply by 8 Pattern Sheet.) Let's practice multiplying by 8. Be sure to work left to right across the page.



### Equivalent Counting with Units of 7 (4 minutes)

Note: This activity builds fluency with multiplication facts using units of 7.

T: Count by sevens to 70. (Write as students count.)

S: 7, 14, 21, 28, 35, 42, 49, 56, 63, 70.

T: (Write 1 seven beneath the 7.) Count to 10 sevens. (Write as students count.)

7	14	21	28	35	42	49	56	63	70
1 seven	2 sevens	3 sevens	4 sevens	5 sevens	6 sevens	7 sevens	8 sevens	9 sevens	10 sevens

S: 1 seven, 2 sevens, 3 sevens, 4 sevens, 5 sevens, 6 sevens, 7 sevens, 8 sevens, 9 sevens, 10 sevens.

T: Let's count to 10 sevens again. This time, stop when I raise my hand.

S: 1 seven, 2 sevens, 3 sevens.

T: (Raise hand.) Say the multiplication sentence.

S:  $3 \times 7 = 21$ .

T: Continue.

S: 4 sevens, 5 sevens.

T: (Raise hand.) Say the multiplication sentence.

S:  $5 \times 7 = 35$ .

T: Continue.

S: 6 sevens, 7 sevens, 8 sevens.

T: (Raise hand.) Say the multiplication sentence.

S:  $8 \times 7 = 56$ .

T: Continue.

S: 9 sevens, 10 sevens.

T: (Raise hand.) Say the multiplication sentence.

S:  $10 \times 7 = 70$ .

T: Let's count back down, starting at 10 sevens.

Continue the process back down to 1 seven.

### Application Problem (5 minutes)

A rectangular sheep pen measures 5 meters long and 9 meters wide. The perimeter of the cow pen is double the perimeter of the sheep pen. What is the perimeter of the cow pen?

Note: The Application Problem reviews Lesson 13 in solving perimeter word problems with given side lengths.

Sheep pen:

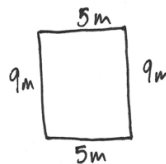

$$\begin{aligned}
 P &= 5m + 5m + 9m + 9m \\
 &= 10m + 18m \\
 &= 28m
 \end{aligned}$$

Cow pen:

$$\begin{aligned}
 P &= 28m + 28m \\
 &= 56m
 \end{aligned}$$

The perimeter of the cow pen is 56 meters.

### Concept Development (33 minutes)

Materials: (S) Personal white board

#### Problem 1: Find the perimeter of rectangles with unknown side lengths.

T: (Project or draw the rectangle as shown.) This shape is a rectangle. Use the given side lengths and what you know about rectangles to label the unknown side lengths.

S: (Label the unknown side lengths.)

T: (Label the unknown side lengths 6 cm and 9 cm.) Check your work against mine, and make changes if you need to. (Allow students time to check their work.) Write an addition sentence that shows the perimeter of the rectangle.

S: (Write  $9\text{ cm} + 9\text{ cm} + 6\text{ cm} + 6\text{ cm} = 30\text{ cm}$ .)

T: What is the perimeter of the rectangle?

S: 30 centimeters!

T: Talk to a partner. What strategy did you use to add the side lengths?

S: I doubled 9 and doubled 6 and then added 18 plus 12 to get 30. → I added 9 plus 6 to get 15 and then doubled 15 to get 30. → I took 1 from each 6 to make tens with the 9's. Then, I added  $10 + 5 + 10 + 5$ . I saw that I had 3 tens, which is 30.

Repeat the process with the suggestions below. Students can sketch the rectangles with the given side lengths, label the unknown side lengths, and then find the perimeter.

- A rectangle with side lengths of 10 inches and 8 inches.
- A rectangle with side lengths of 14 centimeters and 36 centimeters.

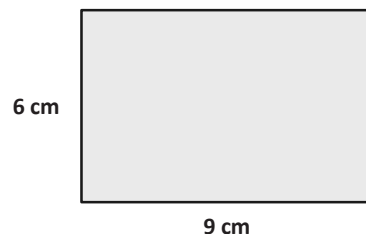

#### NOTES ON MULTIPLE MEANS OF ENGAGEMENT:

Vary the difficulty level of the work in Problem 1 of the Concept Development by adjusting the numbers. Students who understand the concept quickly and calculate perimeter mentally may jump to the last challenge of calculating larger side lengths or side lengths that require conversions, such as the following:

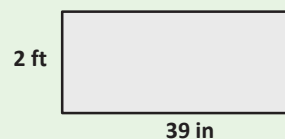

#### Problem 2: Find the perimeter of regular polygons with one side length given.

MP.3

T: (Project or draw the hexagon as shown.) This is a regular hexagon. Talk to a partner. How can the labeled side length help you find the unknown side lengths?

S: Since I know it's a regular hexagon, and I know one side length, I know the other side lengths. → Yeah. Since it's a regular hexagon, I know that all the side lengths are equal. So, all 6 sides are each 3 centimeters.

T: That's right. Sketch the hexagon on your personal white board, and label the unknown side lengths.

S: (Sketch and label the unknown side lengths.)

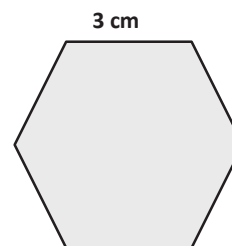

- T: Write an addition sentence that shows the perimeter of the hexagon.
- S: (Write  $3\text{ cm} + 3\text{ cm} + 3\text{ cm} + 3\text{ cm} + 3\text{ cm} + 3\text{ cm} = 18\text{ cm}$ .)
- T: What is the perimeter of the hexagon?
- S: 18 centimeters!
- T: Talk to a partner. Can you write your addition sentence as a multiplication sentence?
- S: Yes. It's repeated addition of 3. I can show that with multiplication.  $\rightarrow$  It shows 6 threes. I can write that as  $6 \times 3$ .
- T: Write a multiplication sentence that shows the perimeter of the hexagon.
- S: (Write  $6 \times 3 = 18$ .)
- T: Discuss with a partner what the factors in this multiplication sentence represent.
- S: The 6 is the number of sides on the hexagon, and the 3 is the length of each of those sides.
- T: Rewrite your multiplication sentence with units to show 6 sides times the length of each side.
- S: (Write  $6 \times 3\text{ cm} = 18\text{ cm}$ .)



### NOTES ON MULTIPLE MEANS OF REPRESENTATION:

Because *regular* has multiple meanings, a specific reminder to English language learners that it means *equal-sided* when used in the context of *regular* polygon may be helpful.

Repeat the process with the suggestions below. Students write both an addition and a multiplication sentence to find the perimeter of each shape.

- A regular pentagon with side lengths of 7 inches.
- A regular triangle (equilateral triangle) with side lengths of 17 centimeters. (Discuss using the break apart and distribute strategy to solve with multiplication.)

T: Talk to a partner: Which method is more efficient for finding the perimeter of a regular shape, adding or multiplying?

MP.3

S: I think multiplying is because it's faster than adding.  $\rightarrow$  If the side lengths are small numbers, then multiplying. But if the side lengths were bigger, like 154, I would add instead.

### Problem Set (10 minutes)

Students should do their personal best to complete the Problem Set within the allotted 10 minutes. For some classes, it may be appropriate to modify the assignment by specifying which problems they work on first. Some problems do not specify a method for solving. Students should solve these problems using the RDW approach used for Application Problems.

Name: Gina Date: \_\_\_\_\_

1. Label the unknown side lengths of the regular shapes below. Then, find the perimeter of each shape.

a. Perimeter = 56 in  
 $7 \times 8 = 56$

b. Perimeter = 21 ft  
 $3 \times 7 = 21$

c. Perimeter = 36 m  
 $4 \times 9 = 36$

d. Perimeter = 30 in  
 $5 \times 6 = 30$

2. Label the unknown side lengths of the rectangle below. Then, find the perimeter of the rectangle.

Perimeter = 18 cm  
 $P = 7\text{ cm} + 7\text{ cm} + 2\text{ cm} + 2\text{ cm}$   
 $= 14\text{ cm} + 4\text{ cm}$   
 $= 18\text{ cm}$

## Student Debrief (10 minutes)

**Lesson Objective:** Determine the perimeter of regular polygons and rectangles when whole number measurements are unknown.

The Student Debrief is intended to invite reflection and active processing of the total lesson experience.

Invite students to review their solutions for the Problem Set. They should check work by comparing answers with a partner before going over answers as a class. Look for misconceptions or misunderstandings that can be addressed in the Debrief. Guide students in a conversation to debrief the Problem Set and process the lesson.

Any combination of the questions below may be used to lead the discussion.

- Compare your work for Problem 1 with a partner's work. Did you add or multiply to find the perimeters? Why?
- How was finding the perimeter in Problem 2 different from finding the perimeters in Problem 1?
- Tell your partner an addition and a multiplication equation for Problem 3. How are the equations related? How do they represent the perimeter of the octagon?
- What strategy did you use to add the side lengths in Problem 4? Explain your strategy choice to a partner.
- Share your answers to Problem 5. Whose strategy is more efficient, Giles's or Xander's? Why?
- Explain to a partner how to find the perimeter of a regular shape given the name or picture of the shape and a side length.

3. David draws a regular octagon and labels a side length as shown below. Find the perimeter of David's octagon.



$8 \times 6 = 48$   
The perimeter of David's octagon is 48 cm. I multiplied the number of sides times the side length.

4. Paige paints an 8-inch by 9-inch picture for her mom's birthday. What is the total length of wood that Paige needs to make a frame for the picture?

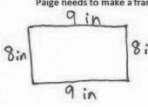

$P = 9 \text{ in} + 9 \text{ in} + 8 \text{ in} + 8 \text{ in}$   
 $= 18 \text{ in} + 16 \text{ in}$   
 $= 34 \text{ in}$   
Paige needs 34 inches of wood.

5. Mr. Spooner draws a regular hexagon on the board. One of the sides measures 4 centimeters. Giles and Xander find the perimeter. Their work is shown below. Whose work is correct? Explain your answer.

Giles' Work	Xander's Work
Perimeter = $4 \text{ cm} + 4 \text{ cm} + 4 \text{ cm} + 4 \text{ cm} + 4 \text{ cm} + 4 \text{ cm}$	Perimeter = $6 \times 4 \text{ in}$
Perimeter = 24 cm	Perimeter = 24 cm

They are both right! A regular hexagon has 6 equal sides. Giles added 4 six times and Xander multiplied the number of sides by the length of each side. Both equations show the perimeter of the regular hexagon.

## Exit Ticket (3 minutes)

After the Student Debrief, instruct students to complete the Exit Ticket. A review of their work will help with assessing students' understanding of the concepts that were presented in today's lesson and planning more effectively for future lessons. The questions may be read aloud to the students.

Multiply.

$8 \times 1 = \underline{\quad\quad}$      $8 \times 2 = \underline{\quad\quad}$      $8 \times 3 = \underline{\quad\quad}$      $8 \times 4 = \underline{\quad\quad}$

$8 \times 5 = \underline{\quad\quad}$      $8 \times 6 = \underline{\quad\quad}$      $8 \times 7 = \underline{\quad\quad}$      $8 \times 8 = \underline{\quad\quad}$

$8 \times 9 = \underline{\quad\quad}$      $8 \times 10 = \underline{\quad\quad}$      $8 \times 5 = \underline{\quad\quad}$      $8 \times 6 = \underline{\quad\quad}$

$8 \times 5 = \underline{\quad\quad}$      $8 \times 7 = \underline{\quad\quad}$      $8 \times 5 = \underline{\quad\quad}$      $8 \times 8 = \underline{\quad\quad}$

$8 \times 5 = \underline{\quad\quad}$      $8 \times 9 = \underline{\quad\quad}$      $8 \times 5 = \underline{\quad\quad}$      $8 \times 10 = \underline{\quad\quad}$

$8 \times 6 = \underline{\quad\quad}$      $8 \times 5 = \underline{\quad\quad}$      $8 \times 6 = \underline{\quad\quad}$      $8 \times 7 = \underline{\quad\quad}$

$8 \times 6 = \underline{\quad\quad}$      $8 \times 8 = \underline{\quad\quad}$      $8 \times 6 = \underline{\quad\quad}$      $8 \times 9 = \underline{\quad\quad}$

$8 \times 6 = \underline{\quad\quad}$      $8 \times 7 = \underline{\quad\quad}$      $8 \times 6 = \underline{\quad\quad}$      $8 \times 7 = \underline{\quad\quad}$

$8 \times 8 = \underline{\quad\quad}$      $8 \times 7 = \underline{\quad\quad}$      $8 \times 9 = \underline{\quad\quad}$      $8 \times 7 = \underline{\quad\quad}$

$8 \times 8 = \underline{\quad\quad}$      $8 \times 6 = \underline{\quad\quad}$      $8 \times 8 = \underline{\quad\quad}$      $8 \times 7 = \underline{\quad\quad}$

$8 \times 8 = \underline{\quad\quad}$      $8 \times 9 = \underline{\quad\quad}$      $8 \times 9 = \underline{\quad\quad}$      $8 \times 6 = \underline{\quad\quad}$

$8 \times 9 = \underline{\quad\quad}$      $8 \times 7 = \underline{\quad\quad}$      $8 \times 9 = \underline{\quad\quad}$      $8 \times 8 = \underline{\quad\quad}$

$8 \times 9 = \underline{\quad\quad}$      $8 \times 8 = \underline{\quad\quad}$      $8 \times 6 = \underline{\quad\quad}$      $8 \times 9 = \underline{\quad\quad}$

$8 \times 7 = \underline{\quad\quad}$      $8 \times 9 = \underline{\quad\quad}$      $8 \times 6 = \underline{\quad\quad}$      $8 \times 8 = \underline{\quad\quad}$

$8 \times 9 = \underline{\quad\quad}$      $8 \times 7 = \underline{\quad\quad}$      $8 \times 6 = \underline{\quad\quad}$      $8 \times 8 = \underline{\quad\quad}$

multiply by 8 (6–10)

Name \_\_\_\_\_

Date \_\_\_\_\_

1. Label the unknown side lengths of the regular shapes below. Then, find the perimeter of each shape.

a.

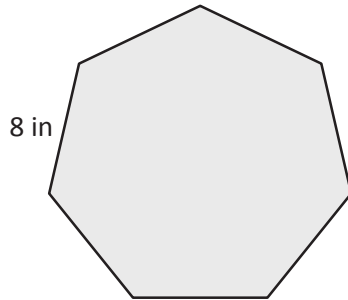

Perimeter = \_\_\_\_\_ in

b.

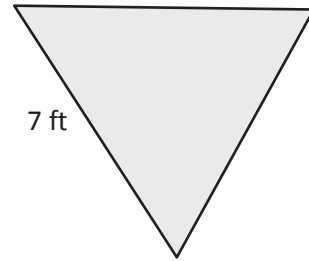

Perimeter = \_\_\_\_\_ ft

c.

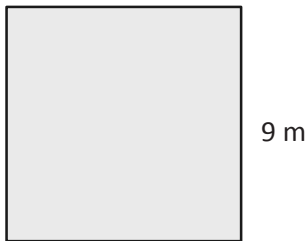

Perimeter = \_\_\_\_\_ m

d.

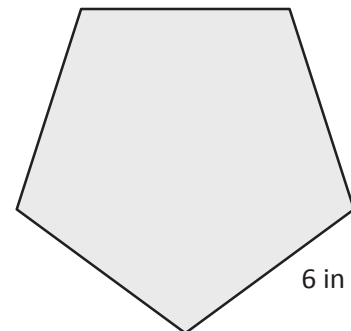

Perimeter = \_\_\_\_\_ in

2. Label the unknown side lengths of the rectangle below. Then, find the perimeter of the rectangle.

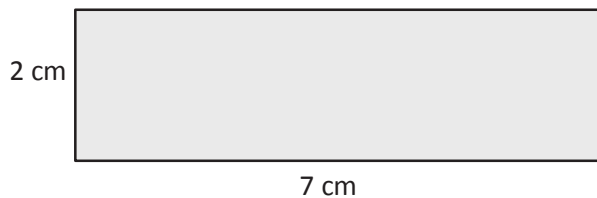

Perimeter = \_\_\_\_\_ cm

3. David draws a regular octagon and labels a side length as shown below. Find the perimeter of David's octagon.

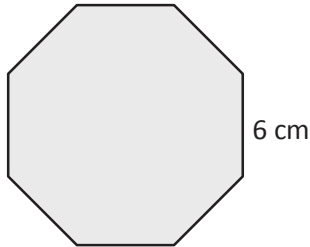

4. Paige paints an 8-inch by 9-inch picture for her mom's birthday. What is the total length of wood that Paige needs to make a frame for the picture?

5. Mr. Spooner draws a regular hexagon on the board. One of the sides measures 4 centimeters. Giles and Xander find the perimeter. Their work is shown below. Whose work is correct? Explain your answer.

**Giles's Work**

$$\text{Perimeter} = 4 \text{ cm} + 4 \text{ cm} + 4 \text{ cm} + 4 \text{ cm} + 4 \text{ cm} + 4 \text{ cm}$$

$$\text{Perimeter} = 24 \text{ cm}$$

**Xander's Work**

$$\text{Perimeter} = 6 \times 4 \text{ cm}$$

$$\text{Perimeter} = 24 \text{ cm}$$

Name \_\_\_\_\_

Date \_\_\_\_\_

Travis traces a regular pentagon on his paper. Each side measures 7 centimeters. He also traces a regular hexagon on his paper. Each side of the hexagon measures 5 centimeters. Which shape has a greater perimeter? Show your work.



Name \_\_\_\_\_

Date \_\_\_\_\_

1. Label the unknown side lengths of the regular shapes below. Then, find the perimeter of each shape.

a.

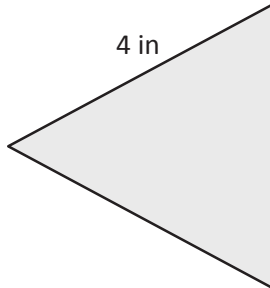

Perimeter = \_\_\_\_\_ in

b.

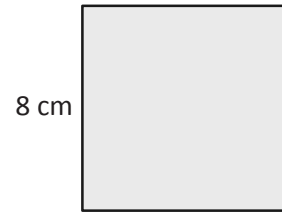

Perimeter = \_\_\_\_\_ cm

c.

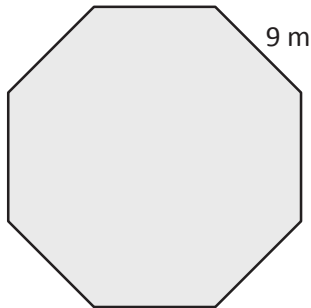

Perimeter = \_\_\_\_\_ m

d.

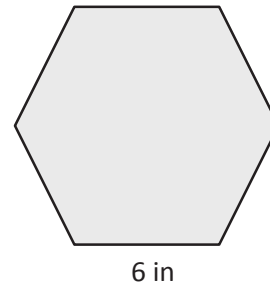

Perimeter = \_\_\_\_\_ in

2. Label the unknown side lengths of the rectangle below. Then, find the perimeter of the rectangle.

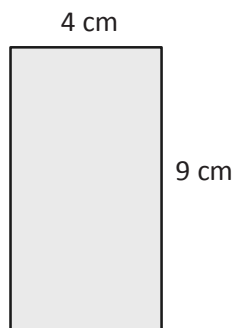

Perimeter = \_\_\_\_\_ cm

3. Roxanne draws a regular pentagon and labels a side length as shown below. Find the perimeter of Roxanne's pentagon.

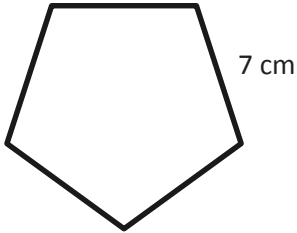

4. Each side of a square field measures 24 meters. What is the perimeter of the field?
5. What is the perimeter of a rectangular sheet of paper that measures 8 inches by 11 inches?

## Lesson 15

**Objective:** Solve word problems to determine perimeter with given side lengths.

### Suggested Lesson Structure

■ Fluency Practice	(15 minutes)
■ Application Problem	(5 minutes)
■ Concept Development	(30 minutes)
■ Student Debrief	(10 minutes)
<b>Total Time</b>	<b>(60 minutes)</b>

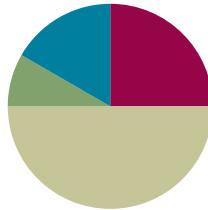

### Fluency Practice (15 minutes)

- Multiply by 9 **3.OA.7** (7 minutes)
- Equivalent Counting with Units of 5 **3.OA.7** (4 minutes)
- Find the Perimeter **3.MD.8** (4 minutes)

### Multiply by 9 (7 minutes)

Materials: (S) Multiply by 9 (1–5) Pattern Sheet

Note: This activity builds fluency with multiplication facts using units of 9. It works toward students knowing from memory all the products of two one-digit numbers. See Lesson 1 for the directions for administration of a Multiply-By Pattern Sheet.

T: (Write  $7 \times 9 = \underline{\quad}$ .) Let's skip-count up by nines. I'll raise a finger for each nine. (Raise a finger for each number to track the count.)

S: 9, 18, 27, 36, 45, 54, 63.

T: Let's skip-count up by nines starting at 45. Why is 45 a good place to start?

S: It's a fact we already know, so we can use it to figure out a fact we don't know.

T: (Track with fingers as students say the numbers.)

S: 45 (5 fingers), 54 (6 fingers), 63 (7 fingers).

T: Let's see how we can skip-count down to find the answer, too. Start at 90 with 10 fingers, 1 for each nine. (Count down with fingers as students say the numbers.)

S: 90 (10 fingers), 81 (9 fingers), 72 (8 fingers), 63 (7 fingers).

Continue with the following possible sequence:  $9 \times 9$ ,  $6 \times 9$ , and  $8 \times 9$ .

T: (Distribute the Multiply by 9 Pattern Sheet.) Let's practice multiplying by 9. Be sure to work left to right across the page.

**Equivalent Counting with Units of 5 (4 minutes)**

Note: This activity builds fluency with multiplication facts using units of 5.

T: Count by fives to 50. (Write as students count.)

S: 5, 10, 15, 20, 25, 30, 35, 40, 45, 50.

T: (Write 1 five beneath the 5.) Count to 10 fives. (Write as students count.)

5	10	15	20	25	30	35	40	45	50
1 five	2 fives	3 fives	4 fives	5 fives	6 fives	7 fives	8 fives	9 fives	10 fives

S: 1 five, 2 fives, 3 fives, 4 fives, 5 fives, 6 fives, 7 fives, 8 fives, 9 fives, 10 fives.

T: Let's count to 10 fives again. This time, stop when I raise my hand.

S: 1 five, 2 fives, 3 fives.

T: (Raise hand.) Say the multiplication sentence.

S:  $3 \times 5 = 15$ .

T: Continue.

S: 4 fives, 5 fives.

T: (Raise hand.) Say the multiplication sentence.

S:  $5 \times 5 = 25$ .

T: Continue.

S: 6 fives, 7 fives, 8 fives.

T: (Raise hand.) Say the multiplication sentence.

S:  $8 \times 5 = 40$ .

T: Continue.

S: 9 fives, 10 fives.

T: (Raise hand.) Say the multiplication sentence.

S:  $10 \times 5 = 50$ .

T: Let's count back down starting at 10 fives.

Continue the process back down to 1 five.

**Find the Perimeter (4 minutes)**

Materials: (S) Personal white board

Note: This activity reviews finding perimeter.

T: (Project a square with side lengths of 7 inches. Write  $P = \underline{\quad}$  in +  $\underline{\quad}$  in +  $\underline{\quad}$  in +  $\underline{\quad}$  in.) Copy the equation on your personal white board, and fill in the blanks. Then, write the perimeter of the square.

S: (Write  $P = 7$  in +  $7$  in +  $7$  in +  $7$  in and  $P = 28$  in.)

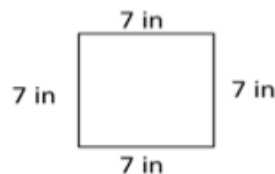

Continue the process with other polygons.

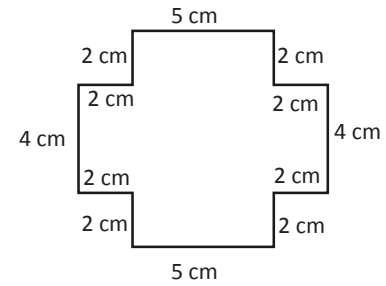
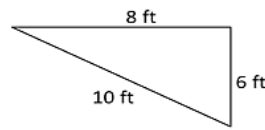
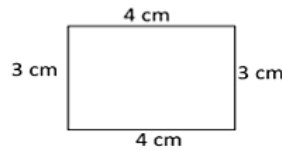
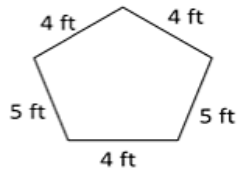

**Application Problem (5 minutes)**

Clara and Pedro each use four 3-inch by 5-inch cards to make the rectangles below. Whose rectangle has a greater perimeter?

Clara's Rectangle

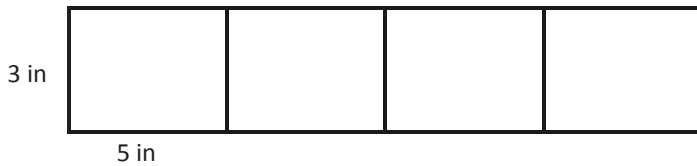

Pedro's Rectangle

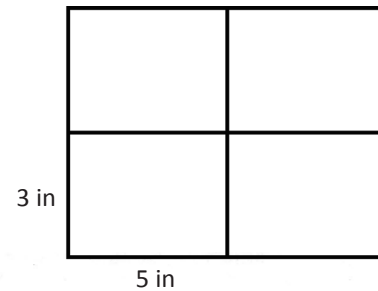

Clara's Rectangle

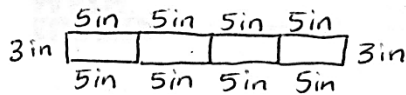

8 fives + 2 threes

$$P = 40\text{ in} + 6\text{ in}$$

$$P = 46\text{ in}$$

Pedro's Rectangle

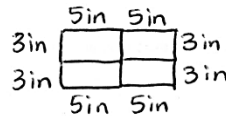

4 fives + 4 threes

$$P = 20\text{ in} + 12\text{ in}$$

$$P = 32\text{ in}$$

Clara's rectangle has a greater perimeter than Pedro's rectangle.

Note: This problem reviews adding side lengths to find the perimeter.

**Concept Development (30 minutes)**

Materials: (S) Problem Set

**Problem 1: Solve perimeter word problems with rectangles.**

Mrs. Kozlow put a border around a 5-foot by 6-foot rectangular bulletin board. How many feet of border did Mrs. Kozlow use?

T: Read Problem 1. (Allow students time to read.) What can you draw to help you solve this problem?

S: A rectangle!

T: Draw and label a rectangle to represent Mrs. Kozlow's bulletin board.

S: (Draw a rectangle and label the side lengths.)

T: (Point to the width and length of the rectangle.) How did you label the width and the length?

S: 5 feet for the width and 6 feet for the length!

T: (Label the length and width.) Check your rectangle against mine. (Allow students to check and make adjustments, if necessary.) Talk to a partner. Can you find the perimeter of the bulletin board with the information in your picture?

MP.5

S: No. I need to know all the side lengths. → Wait. We can use the side lengths we know to label the unknown ones. → Yeah. Since it's a rectangle, opposite sides are equal. → I already labeled all the side lengths.

T: Use what you know about rectangles to label the unknown side lengths if you didn't already.

S: (Label the unknown side lengths.)

T: Write a number sentence including the units to show the perimeter as the sum of the side lengths.

S:  $5\text{ ft} + 6\text{ ft} + 5\text{ ft} + 6\text{ ft} = 22\text{ ft}$ . →  $2 \times 5\text{ ft} + 2 \times 6\text{ ft} = 22\text{ ft}$ .  
→  $10\text{ ft} + 12\text{ ft} = 22\text{ ft}$ . →  $11\text{ ft} + 11\text{ ft} = 22\text{ ft}$ .

T: What is the perimeter of the bulletin board?

S: 22 feet!

T: How many feet of border did Mrs. Kozlow use?

S: 22 feet of border!

T: Look at your number sentence. What strategy did you use or could you use to find the perimeter?

S: I could add 5 and 6 and then double the sum to get 22.  
→ I could multiply each side length by 2 and then add the products.

T: How would you find the total amount of border Mrs. Kozlow used if she put a border around three bulletin boards that are the same size as this one?

S: I would add 22, plus 22, plus 22. → I could multiply 22 times 3, but I don't know that fact. → I could do 3 times 2 tens plus 3 times 3 ones.



### NOTES ON MULTIPLE MEANS OF ENGAGEMENT:

Students working above grade level may solve Problem 1 in the Concept Development quickly using mental math. Allow students to work independently, provided that they include a labeled model, number sentence, and answer sentence for their solutions. Extend the problem by asking students to model a rectangular bulletin board with the same area as Mrs. Kozlow's but with a greater perimeter.

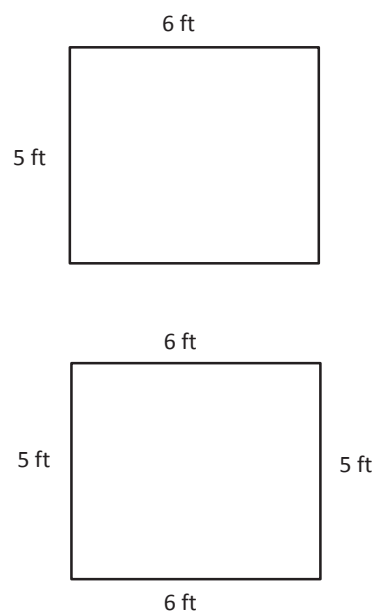

**Problem 2: Solve perimeter word problems with regular polygons.**

Jason built a model of the Pentagon for a social studies project. He made each outside wall 33 centimeters long. What is the perimeter of Jason’s model pentagon?

T: Read Problem 2. (Allow students time to read.) What can you draw to help you solve this problem?

S: A pentagon!

T: Draw and label a pentagon to represent Jason’s model pentagon.

S: (Draw a pentagon and label the side lengths.)

T: Talk to a partner. What did you label the side lengths? Why?

S: I labeled them 33 centimeters because it said each side is 33 centimeters long.

T: Write a number sentence to show the perimeter as the sum of the side lengths.

S: (Write  $33\text{ cm} + 33\text{ cm} + 33\text{ cm} + 33\text{ cm} + 33\text{ cm} = 165\text{ cm}$ .)

T: What is the perimeter of Jason’s model pentagon?

S: 165 centimeters!

T: Look at your number sentence. Is there another way you can find the perimeter?

**MP.5**

S: I could add 66 twice and then 33 more. → I could multiply 33 times 5, but I don’t know that fact. → I could break apart 33 into 30 and 3. Then, I could multiply 5 times 3 tens and 5 times 3 ones and add the products. → I can use the break apart and distribute strategy!



### NOTES ON MULTIPLE MEANS OF ACTION AND EXPRESSION:

The Problem Set makes reference to the Pentagon (see the problem text to the left). Students may not know what the word *pentagon* refers to when it is used as a proper noun. Clarify before starting Problem 2.



### NOTES ON MULTIPLE MEANS OF REPRESENTATION:

Students who find drawing a regular pentagon challenging may draw an alternative model, such as a tape diagram or number bond, in which the whole is the sum of the sides.

**Problem Set (10 minutes)**

Students should do their personal best to complete Problems 3–6 on the Problem Set within the allotted 10 minutes. For some classes, it may be appropriate to modify the assignment by specifying which problems they work on first. Some problems do not specify a method for solving. Students should solve these problems using the RDW approach used for Application Problems.

**Student Debrief (10 minutes)**

**Lesson Objective:** Solve word problems to determine perimeter with given side lengths.

The Student Debrief is intended to invite reflection and active processing of the total lesson experience.

Invite students to review their solutions for the Problem Set. They should check work by comparing answers with a partner before going over answers as a class. Look for misconceptions or misunderstandings that can be addressed in the Debrief. Guide students in a conversation to debrief the Problem Set and process the lesson.

Any combination of the questions below may be used to lead the discussion.

- Share your solution to Problem 3 with a partner. Compare your equations. How are they the same? How are they different?
- What multiplication equation could you use to solve Problem 4? What is 18 tens?
- How was solving Problems 5 and 6 different from the rest of the problems?
- Explain to a partner how you solved Problem 6. Did you use the break apart and distribute strategy? How did you use it?
- Describe a different real-world situation in which it would be necessary to find the perimeter.

### Exit Ticket (3 minutes)

After the Student Debrief, instruct students to complete the Exit Ticket. A review of their work will help with assessing students' understanding of the concepts that were presented in today's lesson and planning more effectively for future lessons. The questions may be read aloud to the students.

Name Gina Date \_\_\_\_\_

1. Mrs. Kozlow put a border around a 5-foot by 6-foot rectangular bulletin board. How many feet of border did Mrs. Kozlow use?

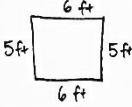

$$P = 5 \text{ ft} + 5 \text{ ft} + 6 \text{ ft} + 6 \text{ ft}$$

$$= 10 \text{ ft} + 12 \text{ ft}$$

$$= 22 \text{ ft}$$

Mrs. Kozlow used 22 feet of border.

2. Jason built a model of the Pentagon for a social studies project. He made each outside wall 33 centimeters long. What is the perimeter of Jason's model Pentagon?

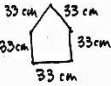

$$P = 33 \text{ cm} + 33 \text{ cm} + 33 \text{ cm} + 33 \text{ cm} + 33 \text{ cm}$$

$$= 66 \text{ cm} + 66 \text{ cm} + 33 \text{ cm}$$

$$= 66 \text{ cm} + 99 \text{ cm}$$

$$= 165 \text{ cm} + 100 \text{ cm}$$

The perimeter is 165 cm.

3. The Holmes family plants a rectangular 8-yard by 9-yard vegetable garden. How many yards of fencing do they need to put a fence around the garden?

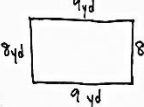

$$P = 9 \text{ yd} + 9 \text{ yd} + 8 \text{ yd} + 8 \text{ yd}$$

$$= 18 \text{ yd} + 16 \text{ yd}$$

$$= 20 \text{ yd} + 14 \text{ yd}$$

$$= 34 \text{ yd}$$

The Holmes family needs 34 yd of fence.

4. Marion paints a 5-pointed star on her bedroom wall. Each side of the star is 18 inches long. What is the perimeter of the star?

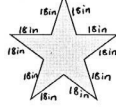

10 eighteens = 18 tens  
18 tens = 180  
So,  $P = 180$  inches  
The perimeter of the star is 180 inches.

5. The soccer team jogs around the outside of the soccer field twice to warm up. The rectangular field measures 60 yards by 100 yards. What is the total number of yards the team jogs?

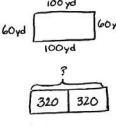

$$P = 100 \text{ yd} + 100 \text{ yd} + 60 \text{ yd} + 60 \text{ yd}$$

$$= 200 \text{ yd} + 120 \text{ yd}$$

$$= 320 \text{ yd}$$

$$320 \text{ yd} + 320 \text{ yd} = 640 \text{ yd}$$

The team jogs a total of 640 yards.

6. Troop 516 makes 3 triangular flags to carry at a parade. They sew ribbon around the outside edges of the flags. The flags' side lengths each measure 24 inches. How many inches of ribbon does the troop use?

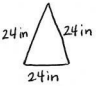

$$P = 24 \text{ in} + 24 \text{ in} + 24 \text{ in}$$

$$= 48 \text{ in} + 24 \text{ in}$$

$$= 72 \text{ in}$$

$$r = 72 \text{ in} + 72 \text{ in} + 72 \text{ in}$$

$$= 144 \text{ in} + 72 \text{ in}$$

$$r = 216 \text{ in}$$

The troop uses 216 inches of ribbon.



Multiply.

$9 \times 1 = \underline{\quad\quad}$      $9 \times 2 = \underline{\quad\quad}$      $9 \times 3 = \underline{\quad\quad}$      $9 \times 4 = \underline{\quad\quad}$

$9 \times 5 = \underline{\quad\quad}$      $9 \times 1 = \underline{\quad\quad}$      $9 \times 2 = \underline{\quad\quad}$      $9 \times 1 = \underline{\quad\quad}$

$9 \times 3 = \underline{\quad\quad}$      $9 \times 1 = \underline{\quad\quad}$      $9 \times 4 = \underline{\quad\quad}$      $9 \times 1 = \underline{\quad\quad}$

$9 \times 5 = \underline{\quad\quad}$      $9 \times 1 = \underline{\quad\quad}$      $9 \times 2 = \underline{\quad\quad}$      $9 \times 3 = \underline{\quad\quad}$

$9 \times 2 = \underline{\quad\quad}$      $9 \times 4 = \underline{\quad\quad}$      $9 \times 2 = \underline{\quad\quad}$      $9 \times 5 = \underline{\quad\quad}$

$9 \times 2 = \underline{\quad\quad}$      $9 \times 1 = \underline{\quad\quad}$      $9 \times 2 = \underline{\quad\quad}$      $9 \times 3 = \underline{\quad\quad}$

$9 \times 1 = \underline{\quad\quad}$      $9 \times 3 = \underline{\quad\quad}$      $9 \times 2 = \underline{\quad\quad}$      $9 \times 3 = \underline{\quad\quad}$

$9 \times 4 = \underline{\quad\quad}$      $9 \times 3 = \underline{\quad\quad}$      $9 \times 5 = \underline{\quad\quad}$      $9 \times 3 = \underline{\quad\quad}$

$9 \times 4 = \underline{\quad\quad}$      $9 \times 1 = \underline{\quad\quad}$      $9 \times 4 = \underline{\quad\quad}$      $9 \times 2 = \underline{\quad\quad}$

$9 \times 4 = \underline{\quad\quad}$      $9 \times 3 = \underline{\quad\quad}$      $9 \times 4 = \underline{\quad\quad}$      $9 \times 5 = \underline{\quad\quad}$

$9 \times 4 = \underline{\quad\quad}$      $9 \times 5 = \underline{\quad\quad}$      $9 \times 1 = \underline{\quad\quad}$      $9 \times 5 = \underline{\quad\quad}$

$9 \times 2 = \underline{\quad\quad}$      $9 \times 5 = \underline{\quad\quad}$      $9 \times 3 = \underline{\quad\quad}$      $9 \times 5 = \underline{\quad\quad}$

$9 \times 4 = \underline{\quad\quad}$      $9 \times 2 = \underline{\quad\quad}$      $9 \times 4 = \underline{\quad\quad}$      $9 \times 3 = \underline{\quad\quad}$

$9 \times 5 = \underline{\quad\quad}$      $9 \times 3 = \underline{\quad\quad}$      $9 \times 2 = \underline{\quad\quad}$      $9 \times 4 = \underline{\quad\quad}$

$9 \times 3 = \underline{\quad\quad}$      $9 \times 5 = \underline{\quad\quad}$      $9 \times 2 = \underline{\quad\quad}$      $9 \times 4 = \underline{\quad\quad}$

---

multiply by 9 (1–5)



4. Marion paints a 5-pointed star on her bedroom wall. Each side of the star is 18 inches long. What is the perimeter of the star?

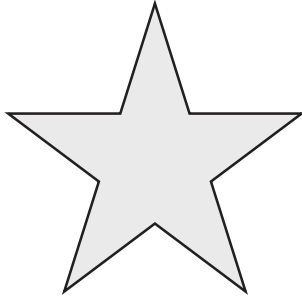

5. The soccer team jogs around the outside of the soccer field twice to warm up. The rectangular field measures 60 yards by 100 yards. What is the total number of yards the team jogs?
6. Troop 516 makes 3 triangular flags to carry at a parade. They sew ribbon around the outside edges of the flags. The flags' side lengths each measure 24 inches. How many inches of ribbon does the troop use?

Name \_\_\_\_\_

Date \_\_\_\_\_

Marlene ropes off a square section of her yard where she plants grass. One side length of the square measures 9 yards. What is the total length of rope Marlene uses?



4. Tyler uses 6 craft sticks to make a hexagon. Each craft stick is 6 inches long. What is the perimeter of Tyler's hexagon?
5. Francis made a rectangular path from her driveway to the porch. The width of the path is 2 feet. The length is 28 feet longer than the width. What is the perimeter of the path?
6. The gym teacher uses tape to mark a 4-square court on the gym floor as shown. The outer square has side lengths of 16 feet. What is the total length of tape the teacher uses to mark Square A?

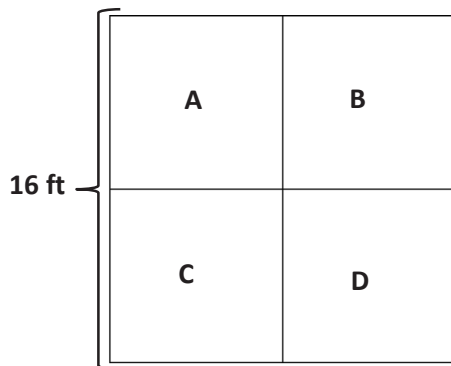

## Lesson 16

**Objective:** Use string to measure the perimeter of various circles to the nearest quarter inch.

### Suggested Lesson Structure

■ Fluency Practice	(16 minutes)
■ Concept Development	(34 minutes)
■ Student Debrief	(10 minutes)
<b>Total Time</b>	<b>(60 minutes)</b>

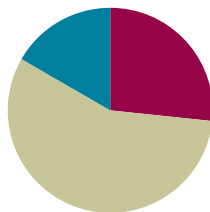

### Fluency Practice (16 minutes)

- Multiply by 9 **3.OA.7** (8 minutes)
- Equivalent Counting with Units of 6 **3.OA.7** (4 minutes)
- Find the Perimeter **3.MD.8** (4 minutes)

### Multiply by 9 (8 minutes)

Materials: (S) Multiply by 9 (6–10) Pattern Sheet

Note: This activity builds fluency with multiplication facts using units of 9. It works toward students knowing from memory all the products of two one-digit numbers. See Lesson 1 for the directions for administration of a Multiply-By Pattern Sheet.

T: (Write  $5 \times 9 = \underline{\quad}$ .) Let's skip-count up by nine to find the answer. (Raise a finger for each number to track the count. Record the skip-count answers on the board.)

S: 9, 18, 27, 36, 45.

T: (Circle 45, and write  $5 \times 9 = 45$  above it. Write  $3 \times 9 = \underline{\quad}$ .) Let's skip-count up by nines again. (Track with fingers as students count.)

S: 9, 18, 27.

T: Let's see how we can skip-count down to find the answer, too. Start at 45 with 5 fingers, 1 for each nine. (Count down with fingers as students say the numbers.)

S: 45 (five fingers), 36 (4 fingers), 27 (3 fingers).

Repeat the process for  $4 \times 9$ .

T: (Distribute the Multiply by 9 Pattern Sheet.) Let's practice multiplying by 9. Be sure to work left to right across the page.

### Equivalent Counting with Units of 6 (4 minutes)

Note: This activity builds fluency with multiplication facts using units of 6.

T: Count by sixes to 60. (Write as students count.)

S: 6, 12, 18, 24, 30, 36, 42, 48, 54, 60.

T: (Write 1 six beneath the 6.) Count to 10 sixes. (Write as students count.)

6	12	18	24	30	36	42	48	54	60
1 six	2 sixes	3 sixes	4 sixes	5 sixes	6 sixes	7 sixes	8 sixes	9 sixes	10 sixes

S: 1 six, 2 sixes, 3 sixes, 4 sixes, 5 sixes, 6 sixes, 7 sixes, 8 sixes, 9 sixes, 10 sixes.

T: Let's count to 10 sixes again. This time, stop when I raise my hand.

S: 1 six, 2 sixes, 3 sixes.

T: (Raise hand.) Say the multiplication sentence.

S:  $3 \times 6 = 18$ .

T: Continue.

S: 4 sixes, 5 sixes.

T: (Raise hand.) Say the multiplication sentence.

S:  $5 \times 6 = 30$ .

T: Continue.

S: 6 sixes, 7 sixes, 8 sixes.

T: (Raise hand.) Say the multiplication sentence.

S:  $8 \times 6 = 48$ .

T: Continue.

S: 9 sixes, 10 sixes.

T: (Raise hand.) Say the multiplication sentence.

S:  $10 \times 6 = 60$ .

T: Let's count back down, starting at 10 sixes.

Continue the pattern back down to 1 six.

### Find the Perimeter (4 minutes)

Materials: (S) Personal white board

Note: This activity reviews Lesson 13.

T: (Project the rectangle with a given length of 5 cm and width of 3 cm.) What is the length of the rectangle?

S: 5 centimeters.

T: What's the width of the rectangle?



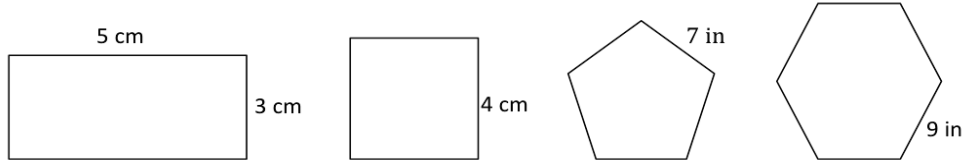

S: 3 centimeters.

T: (Write  $P = \underline{\quad} \text{ cm} + \underline{\quad} \text{ cm} + \underline{\quad} \text{ cm} + \underline{\quad} \text{ cm}$ .) On your personal white board, find the perimeter by writing an addition sentence.

S: (Write  $P = 5 \text{ cm} + 3 \text{ cm} + 5 \text{ cm} + 3 \text{ cm}$  and  $P = 16 \text{ cm}$  beneath it.)

T: (Project the square with a given side length of 4 cm.) What's the length of each side of the square?

S: 4 centimeters.

T: (Write  $P = \underline{\quad} \text{ cm} + \underline{\quad} \text{ cm} + \underline{\quad} \text{ cm} + \underline{\quad} \text{ cm}$ .) Write the perimeter as an addition sentence.

S: (Write  $P = 4 \text{ cm} + 4 \text{ cm} + 4 \text{ cm} + 4 \text{ cm}$  and  $P = 16 \text{ cm}$  beneath it.)

Continue the process with a regular pentagon and a regular hexagon.

### Concept Development (34 minutes)

Materials: (T) Circles (Template) (copied on cardstock), white string, black marker, ruler  
 (S) White string (per pair), ruler, black marker, circle (Template) (one circle per pair, copied on cardstock), personal white board

Note: The white string in the materials list is used in both parts of this lesson. Be sure to cut the string so it is long enough to go around the item with the greatest perimeter in Part 2.

#### Part 1: Use string and a ruler to find the perimeter of a circle.

T: (Pass out a circle to each pair of students.) Talk to your partner. Does this circle have a perimeter?

S: I don't think so because it doesn't have straight lines. → Remember when we made tessellations? Those shapes didn't have straight lines, but they still had perimeters. → The black line shows the boundary of the circle, so that's the circle's perimeter.

T: Can you find the perimeter of the circle in inches using just your ruler?

S: I don't think so.

T: (Pass out white string to each pair of students.) Work with your partner to wrap the string around the perimeter of the circle. (Model.) Partner A, hold the string in place. Partner B, use the black marker to mark the string where it meets the end after going all the way around once.

S: (Mark the string.)

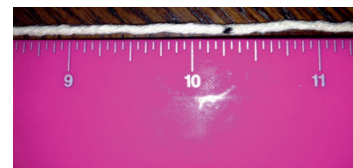
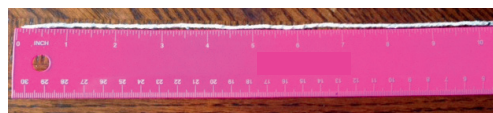

- T: What does the string around the circle represent?
- S: The perimeter of the circle.
- T: How can you use this string and your ruler to find the perimeter of the circle?
- S: We can straighten the string out and measure it. → Since the string has about the same length as the perimeter, we can use our rulers to measure the length of the string to the black mark.
- T: Work with your partner to measure the length of the string from the end to where you made the mark. Record your measurement on your personal white board to the nearest quarter inch.
- S: (Measure the string.)
- T: What is the length of the string to the nearest quarter inch?
- S:  $10\frac{1}{4}$  inches!
- T: So, the perimeter of the circle is...?
- S:  $10\frac{1}{4}$  inches!

**Part 2: Use string and a ruler to find the perimeter of circular objects.**

Materials: (S) Problem Set, markers, variety of circular objects (e.g., paper plates, lids, Frisbee, CDs, pie pans, cups, rolls of masking tape), ruler, white string

Students work in pairs at a station with 10 circular objects, applying what they learned in Part 1 to find the perimeters of those objects. (There may be more than one pair per station.) They use string and a ruler as tools.

- T: Work with a partner at your station to complete the chart in Problem 1 of the Problem Set. Use your string and a ruler to find the perimeters of 10 circular objects. Record the perimeters in the chart to the nearest quarter inch.

Prepare students by doing the following:

- Explain how to use different color markers to mark the perimeter of each object on the string so that they can keep track of the length they are measuring.
- Clarify that, if necessary, students can get a new piece of string.
- Discuss how to use the string and a ruler to find the perimeter of a circular object that has a perimeter greater than 12 inches.
- Remind students that they are working with a partner and that they need to be sure the work is done cooperatively.



**NOTES ON  
MULTIPLE MEANS  
OF ACTION AND  
EXPRESSION:**

Support English language learners as they construct their written responses on the Problem Set. Provide sentence starters and a word bank.

Sentence starters may include  
“I agree/don’t agree because ...”

Possible words for the word bank may include the following:

first	then	next	finally
stretch	string	perimeter	
measure	length	long	because

## Problem Set (10 minutes)

Students should do their personal best to complete the Problem Set within the allotted 10 minutes. For some classes, it may be appropriate to modify the assignment by specifying which problems they work on first. Some problems do not specify a method for solving. Students should solve these problems using the RDW approach used for Application Problems.

## Student Debrief (10 minutes)

**Lesson Objective:** Use string to measure the perimeter of various circles to the nearest quarter inch.

The Student Debrief is intended to invite reflection and active processing of the total lesson experience.

Invite students to review their solutions for the Problem Set. They should check work by comparing answers with a partner before going over answers as a class. Look for misconceptions or misunderstandings that can be addressed in the Debrief. Guide students in a conversation to debrief the Problem Set and process the lesson. Any combination of the questions below may be used to lead the discussion.

- Look at your answers in the chart in Problem 1. Which circular object has the smallest perimeter? The greatest perimeter?
- Discuss your answer to Problem 1(b) with a partner. Can you use just a ruler to find the perimeter of this shape? Why or why not? Can you use your ruler to measure some of the side lengths? Which ones? Then, how would you find the total perimeter?
- Talk to a partner: Do you think the method we used today to find the perimeter of a circle gives the exact perimeter? Why or why not?
- Describe the steps you used to find the perimeter of the circle in Problem 3.
- Share your answers to Problem 4.

MP.6

Name Gina Date \_\_\_\_\_

1. Find the perimeter of 10 circular objects to the nearest quarter inch using string. Record the name and perimeter of each object in the chart below.

Object	Perimeter (to the nearest quarter inch)
Roll of tape	$10\frac{1}{4}$ in
Can of soup	8 in
Top of cup	$11\frac{1}{4}$ in
Pie Pan	$26\frac{3}{4}$ in
Paper plate	$28\frac{3}{4}$ in
Plastic lid	$15\frac{1}{2}$ in
Water bottle	$11\frac{3}{4}$ in
CD	$15\frac{1}{2}$ in
Glue stick	2 $\frac{1}{4}$ in
Flashlight	$7\frac{1}{4}$ in

a. Explain the steps you used to find the perimeter of the circular objects in the chart above.

First I wrapped the string around the perimeter of an object. Then I marked where the string met. Finally, I used a ruler to measure the length of the string to the mark.

b. Could the same process be used to find the perimeter of the shape below? Why or why not?

Yes, the same process could be used to find the perimeter of this shape because I could wrap the string around the perimeter. Then I could mark the string and measure it.



2. Can you find the perimeter of the shape below using just your ruler? Explain your answer.

No, I can't find the perimeter of this shape using just my ruler. The boundary of the shape has curved lines and I can't measure curved lines with just a ruler.

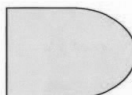

3. Molly says the perimeter of the shape below is  $6\frac{1}{4}$  inches. Use your string to check her work. Do you agree with her? Why or why not?

No, I don't agree with Molly. I used my string and ruler to find the perimeter and it's about  $5\frac{3}{4}$  inches.

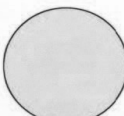

4. Is the process you used to find the perimeter of a circular object an efficient method to find the perimeter of a rectangle? Why or why not?

No, I don't think this is an efficient method to find the perimeter of a rectangle. I can just use my ruler to measure the side lengths. Using the string adds an extra step and the answer is only an estimate.

- Extend the discussion by having students compare the distance across the middle of a circle to the circle's perimeter. They can then estimate to see that the circle's perimeter is about 3 times greater.

### Exit Ticket (3 minutes)

After the Student Debrief, instruct students to complete the Exit Ticket. A review of their work will help with assessing students' understanding of the concepts that were presented in today's lesson and planning more effectively for future lessons. The questions may be read aloud to the students.

Multiply.

$9 \times 1 = \underline{\quad\quad\quad}$      $9 \times 2 = \underline{\quad\quad\quad}$      $9 \times 3 = \underline{\quad\quad\quad}$      $9 \times 4 = \underline{\quad\quad\quad}$

$9 \times 5 = \underline{\quad\quad\quad}$      $9 \times 6 = \underline{\quad\quad\quad}$      $9 \times 7 = \underline{\quad\quad\quad}$      $9 \times 8 = \underline{\quad\quad\quad}$

$9 \times 9 = \underline{\quad\quad\quad}$      $9 \times 10 = \underline{\quad\quad\quad}$      $9 \times 5 = \underline{\quad\quad\quad}$      $9 \times 6 = \underline{\quad\quad\quad}$

$9 \times 5 = \underline{\quad\quad\quad}$      $9 \times 7 = \underline{\quad\quad\quad}$      $9 \times 5 = \underline{\quad\quad\quad}$      $9 \times 8 = \underline{\quad\quad\quad}$

$9 \times 5 = \underline{\quad\quad\quad}$      $9 \times 9 = \underline{\quad\quad\quad}$      $9 \times 5 = \underline{\quad\quad\quad}$      $9 \times 10 = \underline{\quad\quad\quad}$

$9 \times 6 = \underline{\quad\quad\quad}$      $9 \times 5 = \underline{\quad\quad\quad}$      $9 \times 6 = \underline{\quad\quad\quad}$      $9 \times 7 = \underline{\quad\quad\quad}$

$9 \times 6 = \underline{\quad\quad\quad}$      $9 \times 8 = \underline{\quad\quad\quad}$      $9 \times 6 = \underline{\quad\quad\quad}$      $9 \times 9 = \underline{\quad\quad\quad}$

$9 \times 6 = \underline{\quad\quad\quad}$      $9 \times 7 = \underline{\quad\quad\quad}$      $9 \times 6 = \underline{\quad\quad\quad}$      $9 \times 7 = \underline{\quad\quad\quad}$

$9 \times 8 = \underline{\quad\quad\quad}$      $9 \times 7 = \underline{\quad\quad\quad}$      $9 \times 9 = \underline{\quad\quad\quad}$      $9 \times 7 = \underline{\quad\quad\quad}$

$9 \times 8 = \underline{\quad\quad\quad}$      $9 \times 6 = \underline{\quad\quad\quad}$      $9 \times 8 = \underline{\quad\quad\quad}$      $9 \times 7 = \underline{\quad\quad\quad}$

$9 \times 8 = \underline{\quad\quad\quad}$      $9 \times 9 = \underline{\quad\quad\quad}$      $9 \times 9 = \underline{\quad\quad\quad}$      $9 \times 6 = \underline{\quad\quad\quad}$

$9 \times 9 = \underline{\quad\quad\quad}$      $9 \times 7 = \underline{\quad\quad\quad}$      $9 \times 9 = \underline{\quad\quad\quad}$      $9 \times 8 = \underline{\quad\quad\quad}$

$9 \times 9 = \underline{\quad\quad\quad}$      $9 \times 8 = \underline{\quad\quad\quad}$      $9 \times 6 = \underline{\quad\quad\quad}$      $9 \times 9 = \underline{\quad\quad\quad}$

$9 \times 7 = \underline{\quad\quad\quad}$      $9 \times 9 = \underline{\quad\quad\quad}$      $9 \times 6 = \underline{\quad\quad\quad}$      $9 \times 8 = \underline{\quad\quad\quad}$

$9 \times 9 = \underline{\quad\quad\quad}$      $9 \times 7 = \underline{\quad\quad\quad}$      $9 \times 6 = \underline{\quad\quad\quad}$      $9 \times 8 = \underline{\quad\quad\quad}$

multiply by 9 (6–10)

Name \_\_\_\_\_

Date \_\_\_\_\_

1. Find the perimeter of 10 circular objects to the nearest quarter inch using string. Record the name and perimeter of each object in the chart below.

Object	Perimeter (to the nearest quarter inch)

- a. Explain the steps you used to find the perimeter of the circular objects in the chart above.

- b. Could the same process be used to find the perimeter of the shape below? Why or why not?

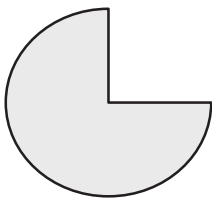

2. Can you find the perimeter of the shape below using just your ruler? Explain your answer.

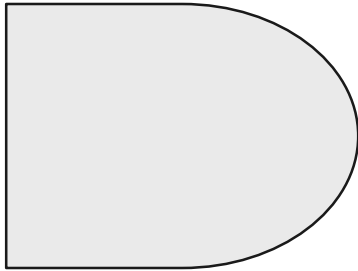

3. Molly says the perimeter of the shape below is  $6\frac{1}{4}$  inches. Use your string to check her work. Do you agree with her? Why or why not?

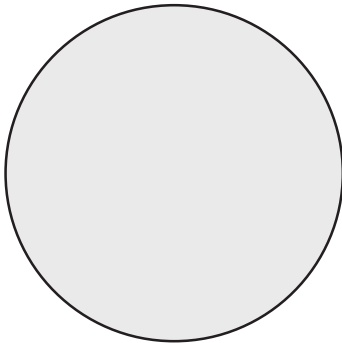

4. Is the process you used to find the perimeter of a circular object an efficient method to find the perimeter of a rectangle? Why or why not?

Name \_\_\_\_\_

Date \_\_\_\_\_

Use your string to find the perimeter of the shape below to the nearest quarter inch.

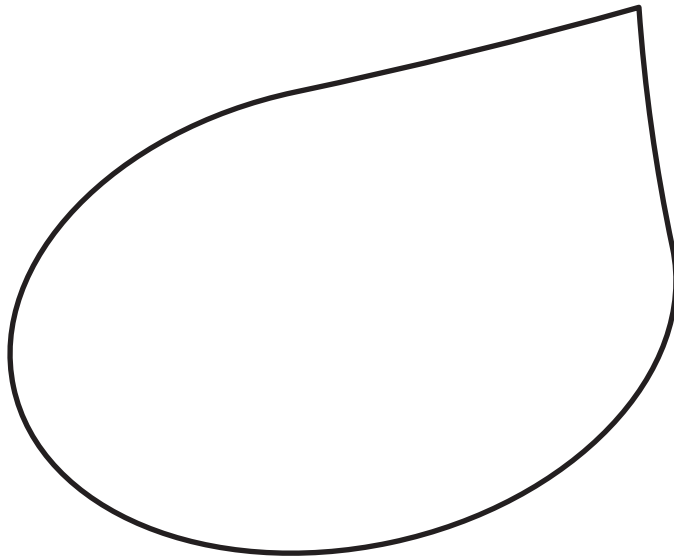



Name \_\_\_\_\_

Date \_\_\_\_\_

1. a. Find the perimeter of 5 circular objects from home to the nearest quarter inch using string. Record the name and perimeter of each object in the chart below.

Object	Perimeter (to the nearest quarter inch)
Example: Peanut Butter Jar Cap	$9\frac{1}{2}$ inches

- b. Explain the steps you used to find the perimeter of the circular objects in the chart above.

2. Use your string and ruler to find the perimeter of the two shapes below to the nearest quarter inch.

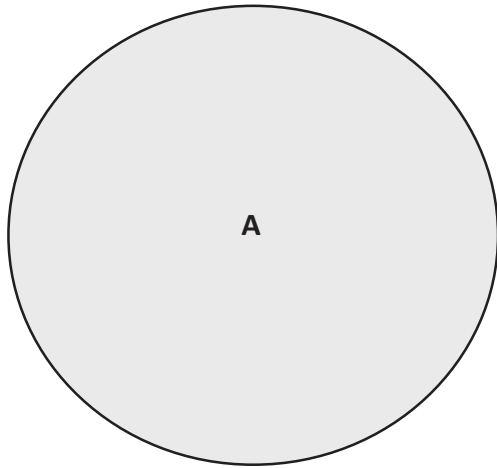

Perimeter = \_\_\_\_\_

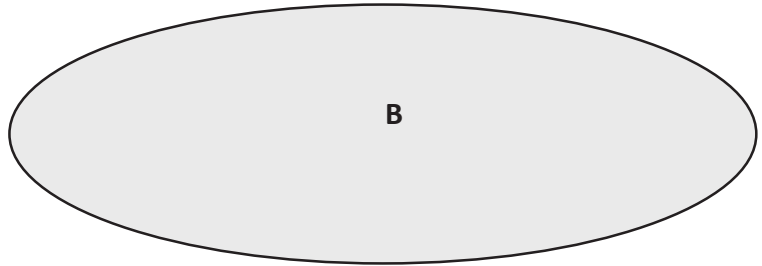

Perimeter = \_\_\_\_\_

- a. Which shape has a greater perimeter?
- b. Find the difference between the two perimeters.
3. Describe the steps you took to find the perimeter of the objects in Problem 2. Would you use this method to find the perimeter of a square? Explain why or why not.

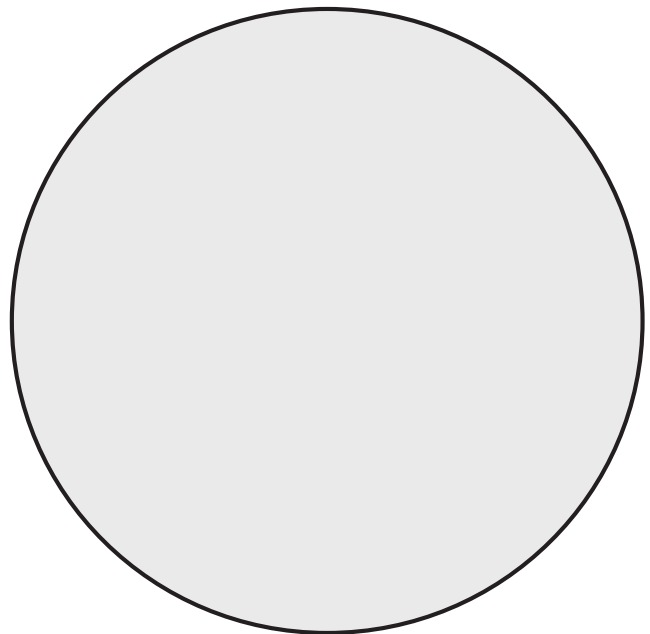
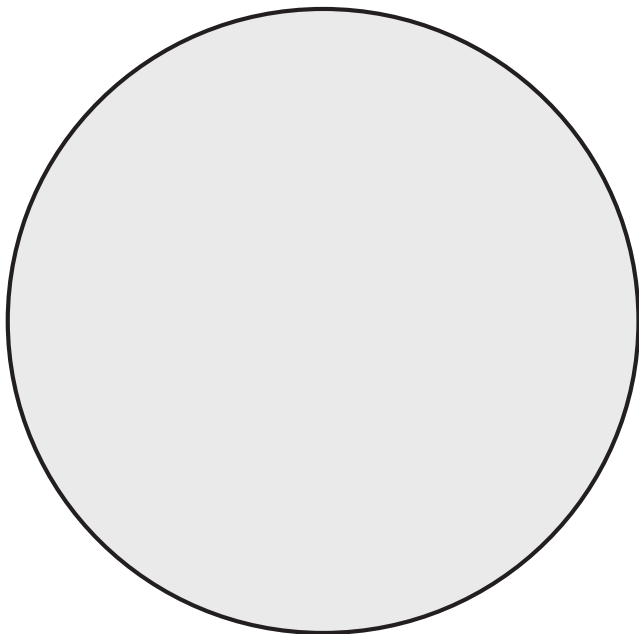
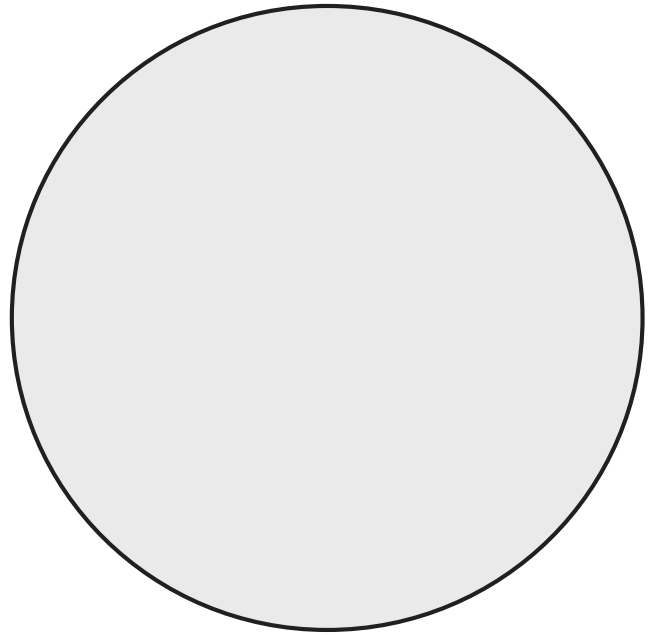
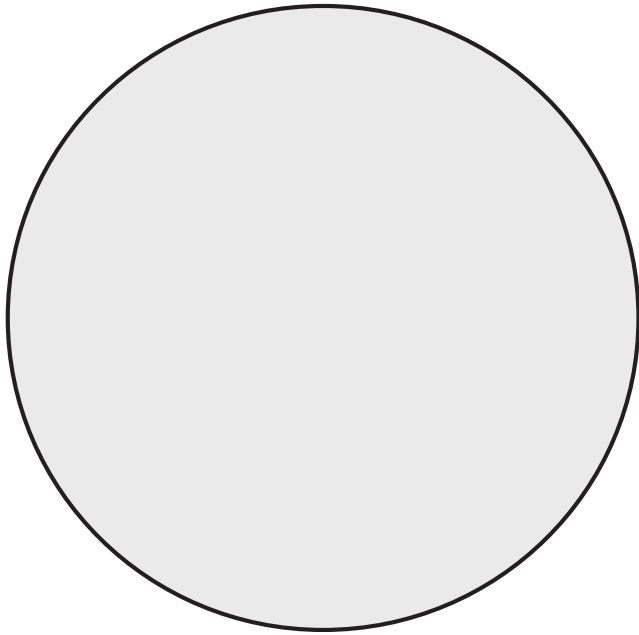

---

circles

## Lesson 17

**Objective:** Use all four operations to solve problems involving perimeter and unknown measurements.

### Suggested Lesson Structure

■ Fluency Practice	(12 minutes)
■ Application Problem	(5 minutes)
■ Concept Development	(33 minutes)
■ Student Debrief	(10 minutes)
<b>Total Time</b>	<b>(60 minutes)</b>

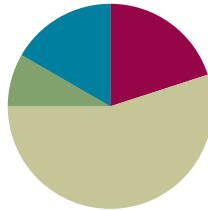

#### NOTES ON MULTIPLE MEANS OF REPRESENTATION:

If using the Marilyn Burns text and lesson listed below, teach it after today's lesson and before the Mid-Module Assessment. Because it explores the relationship between perimeter and area, the lesson works well as a culmination of Topic C while anticipating Topic D, which incorporates area.

Burns, Marilyn. *Spaghetti and Meatballs for All! A Mathematical Story*. New York: Scholastic Press, 1997.

### Fluency Practice (12 minutes)

- Factors **3.MD.4** (4 minutes)
- Equivalent Counting with Units of 8 **3.OA.7** (4 minutes)
- Find the Perimeter **3.MD.8** (4 minutes)

### Factors (4 minutes)

Materials: (S) Personal white board

Note: This activity builds fluency with multiplication and division facts.

T: (Write  $8 \times \underline{\quad} = 8$ .) Say the equation, filling in the unknown factor.

S:  $8 \times 1 = 8$ .

T: (Write  $2 \times \underline{\quad} = 8$ .) Say the equation, filling in the unknown factor.

S:  $2 \times 4 = 8$ .

T: (Write  $\underline{\quad} \times 2 = 8$ .) Write the equation, filling in the unknown factor.

S: (Write  $4 \times 2 = 8$ .)

Continue with the following possible sequence of products: 12, 15, and 24.

### Equivalent Counting with Units of 8 (4 minutes)

Note: This activity builds fluency with multiplication facts using units of 8.

T: Count by eights to 80. (Write as students count.)

S: 8, 16, 24, 32, 40, 48, 56, 64, 72, 80.

T: (Write 1 eight beneath the 8.) Count to 10 eights. (Write as students count.)

8	16	24	32	40	48	56	64	72	80
1 eight	2 eights	3 eights	4 eights	5 eights	6 eights	7 eights	8 eights	9 eights	10 eights

S: 1 eight, 2 eights, 3 eights, 4 eights, 5 eights, 6 eights, 7 eights, 8 eights, 9 eights, 10 eights.

T: Let's count to 10 eights again. This time, stop when I raise my hand.

S: 1 eight, 2 eights, 3 eights.

T: (Raise hand.) Say the multiplication sentence.

S:  $3 \times 8 = 24$ .

T: Continue.

S: 4 eights, 5 eights.

T: (Raise hand.) Say the multiplication sentence.

S:  $5 \times 8 = 40$ .

T: Continue.

S: 6 eights, 7 eights, 8 eights.

T: (Raise hand.) Say the multiplication sentence.

S:  $8 \times 8 = 64$ .

T: Continue.

S: 9 eights, 10 eights.

T: (Raise hand.) Say the multiplication sentence.

S:  $10 \times 8 = 80$ .

T: Let's count back down, starting at 10 eights.

S: 10 eights, 9 eights.

T: (Raise hand.) Say the multiplication sentence.

S:  $9 \times 8 = 72$ .

Continue the process going back down to 1 eight.

### Find the Perimeter (4 minutes)

Materials: (S) Personal white board

Note: This activity reviews Lesson 15.

T: (Project the triangle with a given side length of 4 cm. Write  $P = \underline{\quad}$  cm.) Each shape that I show you is a regular polygon. Say the given side length of the triangle.

S: 4 centimeters.

T: (Write  $P = \underline{\quad} \times \underline{\quad}$  cm.) Fill in the factors. Below, write the perimeter of the triangle.

S: (Write  $P = 3 \times 4$  cm and  $P = 12$  cm below it.)

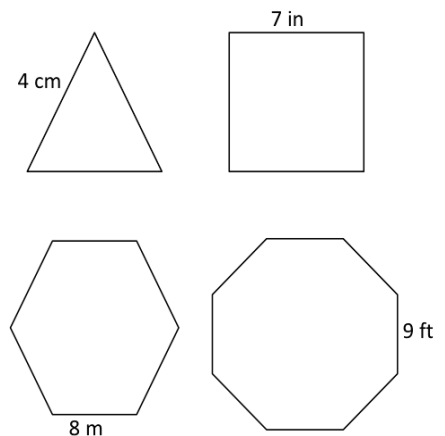

Repeat the process for the other shapes.

### Application Problem (5 minutes)

Gil places two regular hexagons side by side as shown to make a new shape. Each side measures 6 centimeters. Find the perimeter of his new shape.

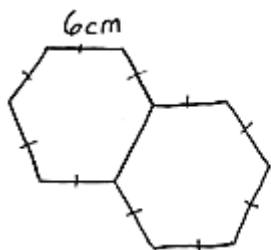

There are 10 sides  
in Gil's new shape.  
 $10 \times 6 = 60$   
The perimeter of  
the shape is 60 cm.

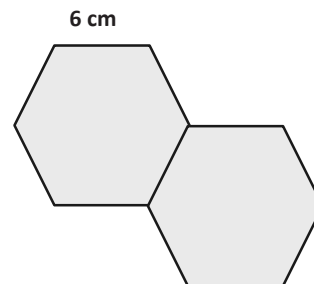

Note: Today's Application Problem reviews finding the perimeter of regular shapes from Lesson 15. Students may also choose to represent their equations as repeated addition.

### Concept Development (33 minutes)

Materials: (S) Personal white board

- T: (Project the image to the right.) Can you visualize the rectangles that make up this shape? Tell your partner about them.
- S: I see one long one that goes from the top all the way to the bottom and then a smaller one stuck on the bottom right.  
→ I see a long skinny one across the bottom and a thicker one on top of it to the left.
- T: Let's find the perimeter of the shape. Say the side length as I point to it. (Point to the labeled side lengths. Students say them.)
- T: (Point to the shorter, unknown side length.)
- S: That side length isn't labeled!
- T: (Write  $a$  cm next to it.) Let's call this side length  $a$  and label the unit with centimeters.
- T: (Point to the longer, unknown side length.)
- S: That one isn't labeled either!
- T: (Write  $b$  cm next to it.) Let's call this side length  $b$  and label the unit with centimeters.
- T: Think back to how you visualized rectangles fitting together to make this shape. (Draw a dashed line as shown.) This is one way to visualize the rectangles. How does the line help you find the unknown side lengths?

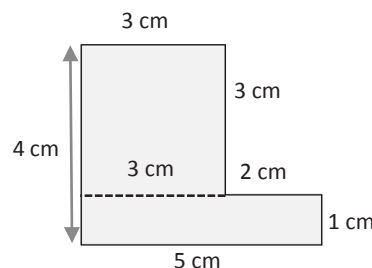
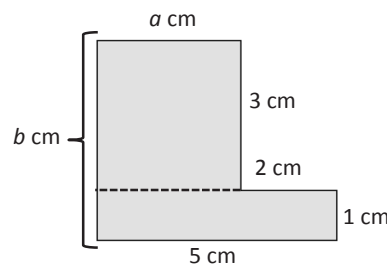
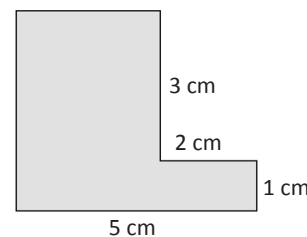

MP.3

S: Now we can see two rectangles. → We can use what we know about rectangles and the given side lengths to find the unknown side lengths. → Yeah. We know that opposite side lengths are equal, which will help us find the unknown side lengths.

T: Work with a partner. Use the bottom rectangle to find the length of the dashed line.

S: If the whole bottom is 5 centimeters, then we have to subtract the 2 centimeters that we know.  
 $5\text{ cm} - 2\text{ cm} = 3\text{ cm}$ . The dashed line is 3 centimeters.

T: (Label the length of the dashed line.) How does this help us find the value of  $a$ ?

S: The dashed line is the side opposite of  $a$ , so  $a$  is 3, too!

T: (Label 3 for  $a$ .) Look at the side lengths for the top rectangle. We know that three side lengths are 3 centimeters. What does that tell us about the fourth side length?

S: It has to be 3 centimeters, too! → It's a square!

T: Does that mean that  $b$  is 3, too?

S: No! → We have to add on the side length from the bottom rectangle to find the total length of  $b$ .

T: Work with a partner to find the total length of  $b$ . (Allow students time to work.) What is the value of  $b$ ?

S: 4.

T: (Label 4 for  $b$ , and draw an arrow as shown on the previous page.) I drew an arrow to show that the length of this entire side is 4 centimeters. Write a number sentence, including units, that shows the perimeter of this shape.

S: (Possible number sentences include the following:  $5\text{ cm} + 1\text{ cm} + 2\text{ cm} + 3\text{ cm} + 3\text{ cm} + 4\text{ cm} = 18\text{ cm}$  or  $(3 \times 3\text{ cm}) + 4\text{ cm} + 5\text{ cm} = 18\text{ cm}$ .)

T: What is the perimeter of the shape?

S: 18 centimeters!

T: (Erase the dashed line and draw the new dashed line as shown.) Discuss with a partner how you would solve by visualizing the rectangles this way instead.

S: (Discuss.)

Continue with the following possible shapes.

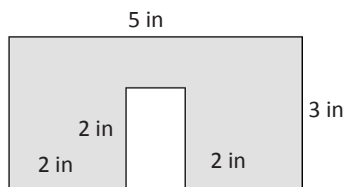

Possible solution path: Draw a dotted line connecting the 2-inch sides to make one large rectangle as shown.

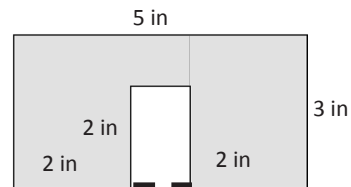
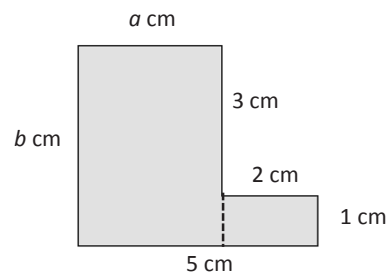

### NOTES ON MULTIPLE MEANS OF ACTION AND EXPRESSION:

Magnifying the composite figure and drawing brackets may make it easier for students to match the measures with the correct sides. In addition, consider marking ticks to show equal sides. If technology is available, consider using color to highlight the two rectangles. Alternate between a one-colored composite figure and the two-colored rectangles.

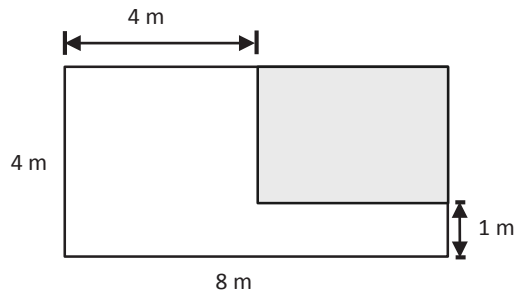

Students might find the perimeter of the shaded rectangle, the unshaded shape, and/or the large rectangle.

### Problem Set (10 minutes)

Students should do their personal best to complete the Problem Set within the allotted 10 minutes. For some classes, it may be appropriate to modify the assignment by specifying which problems they work on first. Some problems do not specify a method for solving. Students should solve these problems using the RDW approach used for Application Problems.

### Student Debrief (10 minutes)

**Lesson Objective:** Use all four operations to solve problems involving perimeter and unknown measurements.

The Student Debrief is intended to invite reflection and active processing of the total lesson experience.

Invite students to review their solutions for the Problem Set. They should check work by comparing answers with a partner before going over answers as a class. Look for misconceptions or misunderstandings that can be addressed in the Debrief. Guide students in a conversation to debrief the Problem Set and process the lesson.

Any combination of the questions below may be used to lead the discussion.

- Compare strategies for finding the unknown side lengths in Problem 1.
- How was finding the unknown side lengths in Problem 1(b) different from finding the unknown side lengths in the rest of the shapes in Problem 1?
- Do the sizes of the shapes in Problem 1 accurately reflect the given units for each side length? Why or why not?
- Explain to your partner how you solved Problem 2. What strategy did you use to find the unknown side lengths? What strategy did you use to add the side lengths?

Name Gina Date \_\_\_\_\_

1. The shapes below are made up of rectangles. Label the unknown side lengths. Then, write and solve an equation to find the perimeter of each shape.

a. 
$$P = (3 \times 2\text{ cm}) + 1\text{ cm} + 3\text{ cm} + 4\text{ cm}$$

$$= 6\text{ cm} + 4\text{ cm} + 4\text{ cm}$$

$$= 14\text{ cm}$$

b. 
$$P = (4 \times 2\text{ ft}) + (3 \times 1\text{ ft}) + 5\text{ ft}$$

$$= 8\text{ ft} + 3\text{ ft} + 5\text{ ft}$$

$$= 16\text{ ft}$$

c. 
$$P = (5 \times 2\text{ m}) + (2 \times 4\text{ m}) + 6\text{ m}$$

$$= 10\text{ m} + 8\text{ m} + 6\text{ m}$$

$$= 10\text{ m} + 14\text{ m}$$

$$= 24\text{ m}$$

d. 
$$P = (7 \times 2\text{ yd}) + 7\text{ yd} + 1\text{ yd} + 4\text{ yd}$$

$$= 14\text{ yd} + 12\text{ yd}$$

$$= 26\text{ yd}$$



- What is the perimeter of the unshaded shape in Problem 3? The large rectangle?
- What attribute about rectangles helped you find the perimeters of the shapes today?

### Exit Ticket (3 minutes)

After the Student Debrief, instruct students to complete the Exit Ticket. A review of their work will help with assessing students' understanding of the concepts that were presented in today's lesson and planning more effectively for future lessons. The questions may be read aloud to the students.

2. Nathan draws and labels the square and rectangle below. Find the perimeter of the new shape.

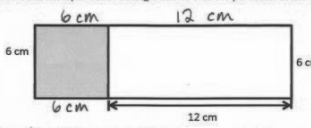

$$P = (4 \times 6 \text{ cm}) + 12 \text{ cm} + 12 \text{ cm}$$

$$= 24 \text{ cm} + 24 \text{ cm}$$

$$= 48 \text{ cm}$$

The perimeter of the shape is 48 cm.

3. Label the unknown side lengths. Then, find the perimeter of the shaded rectangle.

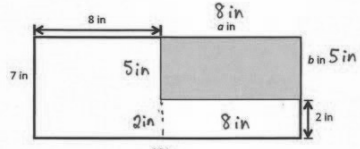

$$P = 8 \text{ in} + 8 \text{ in} + 5 \text{ in} + 5 \text{ in}$$

$$= 16 \text{ in} + 10 \text{ in}$$

$$= 26 \text{ in}$$

The perimeter of the shaded rectangle is 26 inches.

Name \_\_\_\_\_

Date \_\_\_\_\_

1. The shapes below are made up of rectangles. Label the unknown side lengths. Then, write and solve an equation to find the perimeter of each shape.

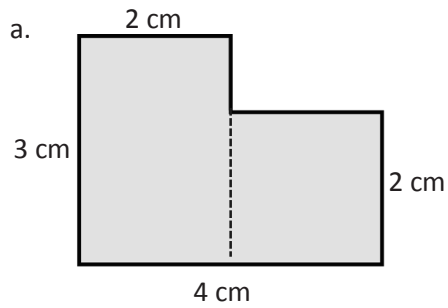

P =

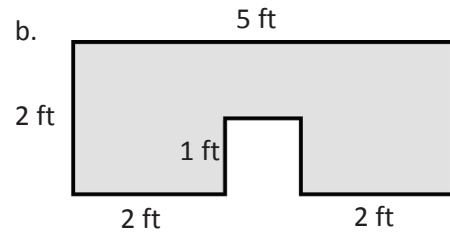

P =

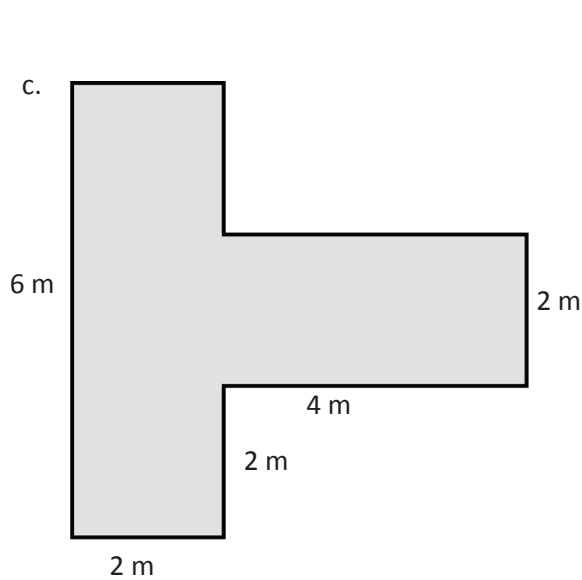

P =

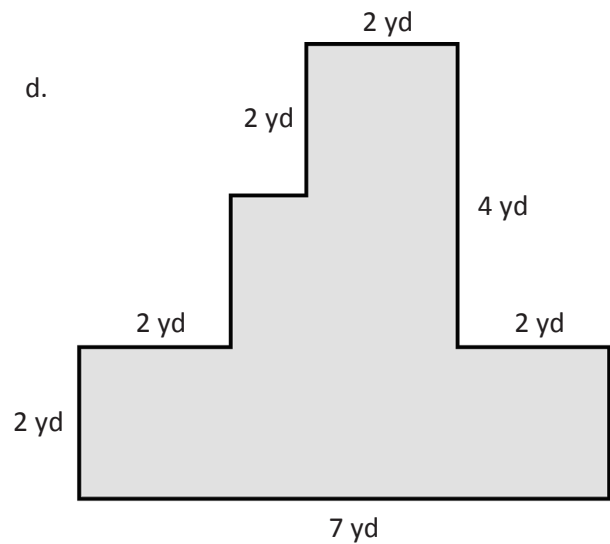

P =

2. Nathan draws and labels the square and rectangle below. Find the perimeter of the new shape.

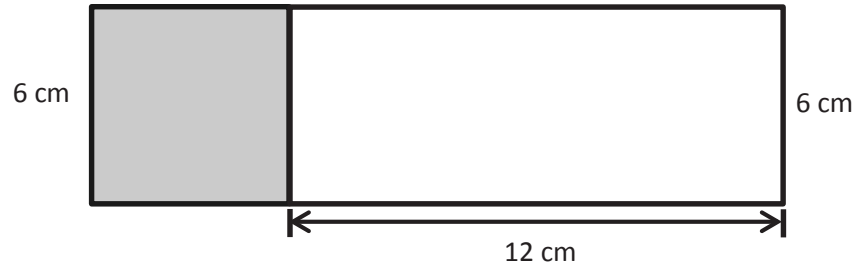

3. Label the unknown side lengths. Then, find the perimeter of the shaded rectangle.

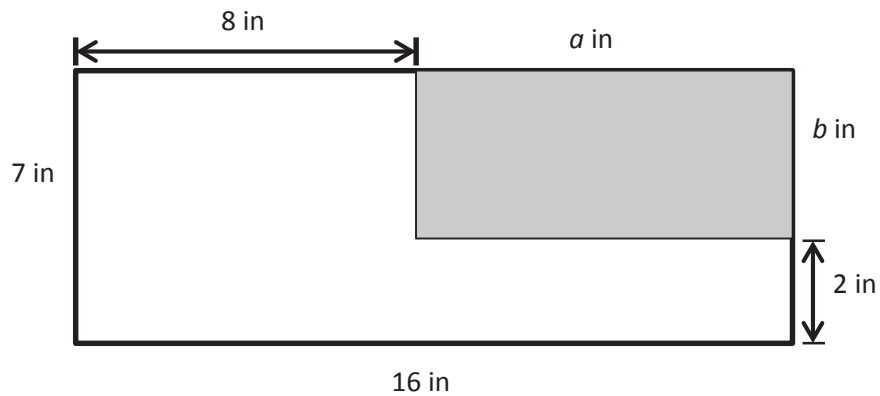

Name \_\_\_\_\_

Date \_\_\_\_\_

Label the unknown side lengths. Then, find the perimeter of the shaded rectangle.

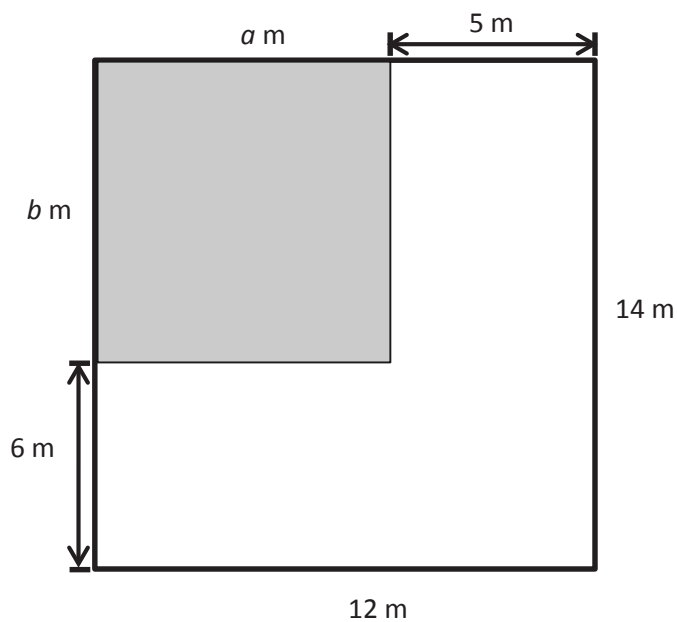

Name \_\_\_\_\_

Date \_\_\_\_\_

1. The shapes below are made up of rectangles. Label the unknown side lengths. Then, write and solve an equation to find the perimeter of each shape.

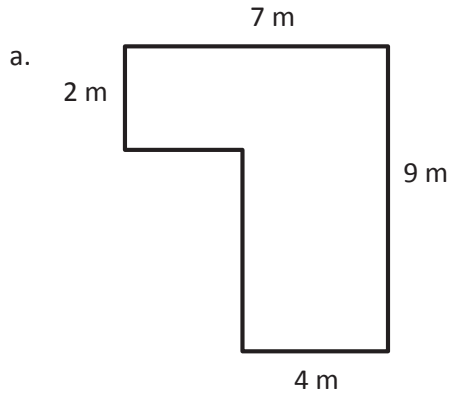

P =

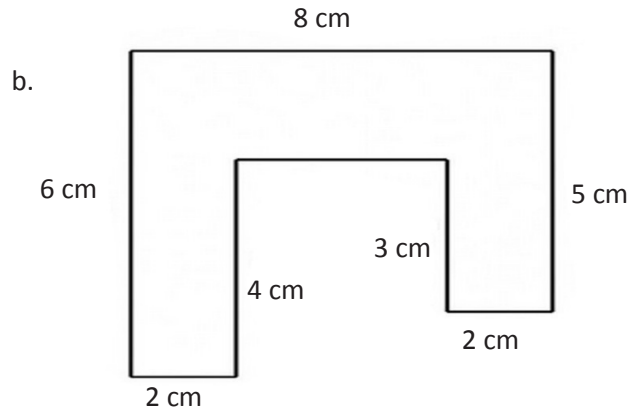

P =

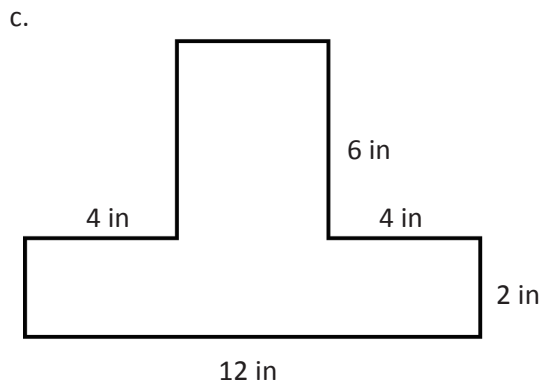

P =

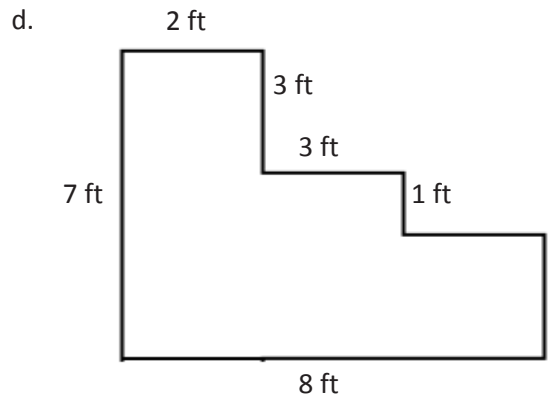

P =

2. Sari draws and labels the squares and rectangle below. Find the perimeter of the new shape.

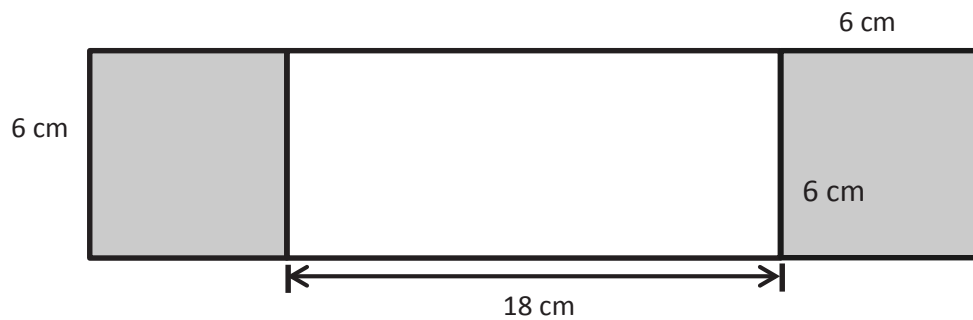

3. Label the unknown side lengths. Then, find the perimeter of the shaded rectangle.

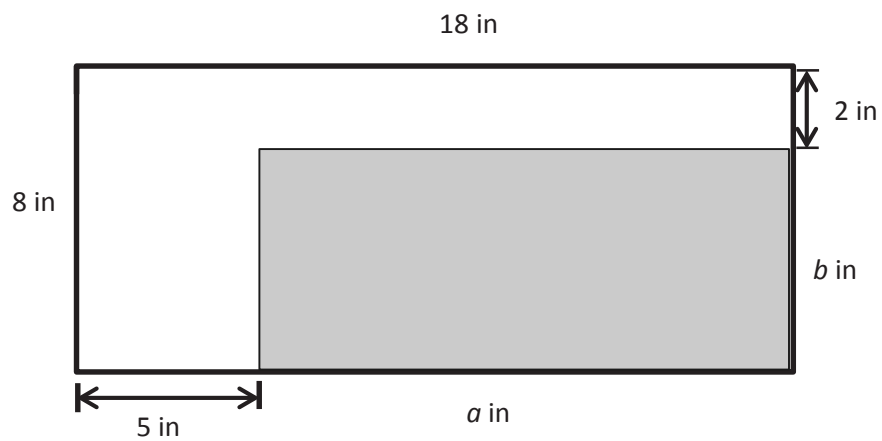

Name \_\_\_\_\_

Date \_\_\_\_\_

1. Three shapes are shown below.
  - a. Circle the shape(s) with only one pair of parallel sides.
  - b. Cross out the shape(s) with two pairs of parallel sides.

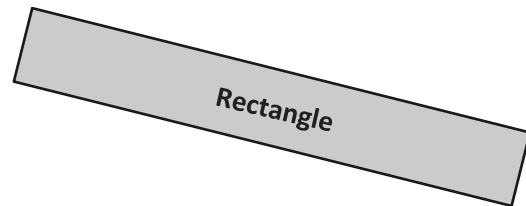
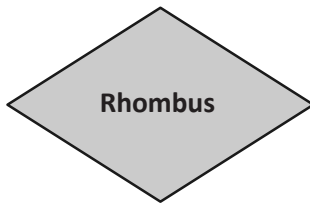

- c. Which of the three shapes are quadrilaterals? Explain how you know.





3. Mr. Cooper builds a fence to make a rectangular horse stall. The stall is 5 meters long and 7 meters wide. How many meters of fence does Mr. Cooper use? Draw a picture and write an equation to show your thinking.

4. Jamal wants to put wood trim around his rectangular bedroom and square closet. His bedroom is 10 feet wide and 8 feet long. His closet is 3 feet wide and 3 feet long.

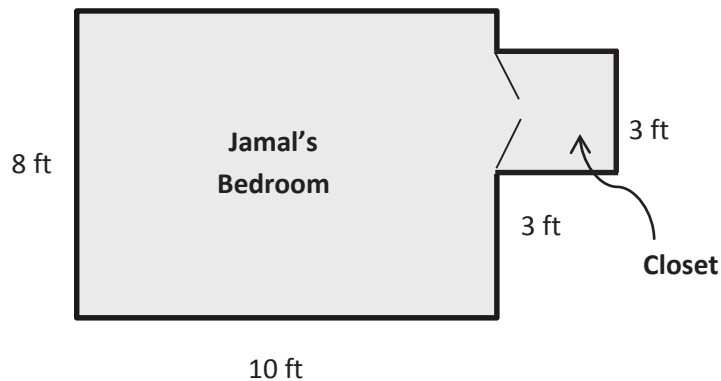

- a. Wood trim is sold by the foot. How many feet of wood trim does Jamal need to go around his bedroom and closet? Show your work.
- b. How much more wood trim does Jamal need for his bedroom than his closet? Write and solve an equation. Use a letter to represent the unknown.

5. The figure below is composed of rectangles. Use the picture and the descriptions to find the perimeter of the shape. Show your work.

- Each side labeled with **A** is 6 inches.
- Each side labeled with **B** is 3 inches.
- Each side labeled with **C** is 8 inches.

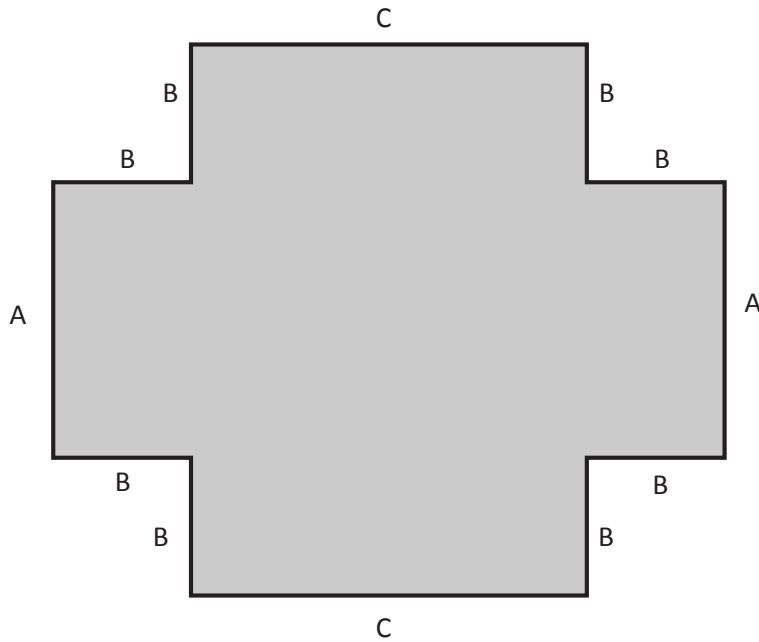

6. Mrs. Gomez builds a fence around her backyard. Her plan shows the fence as a dotted line below.

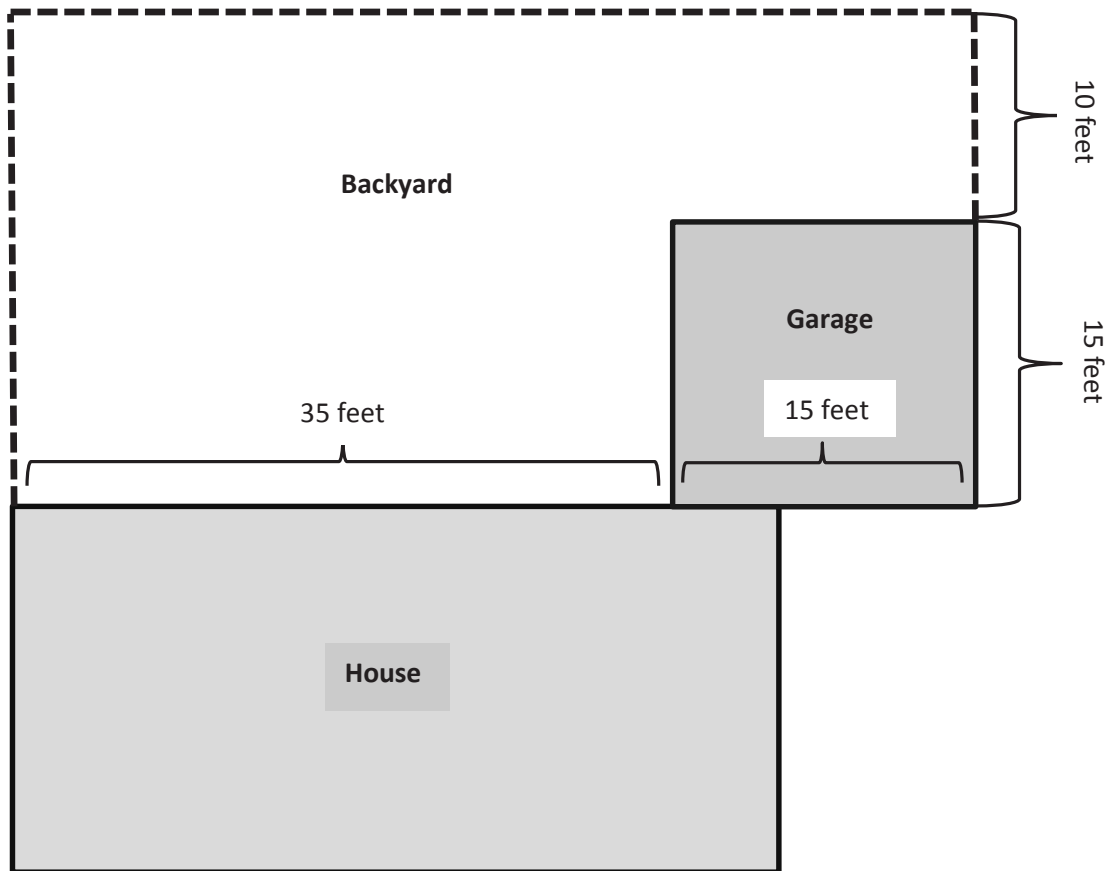

Together, the garage and backyard make a rectangle. The fence goes only where there is a dotted line. How many feet of fence does Mrs. Gomez need to build? Show your work.

**Mid-Module Assessment Task  
Standards Addressed**

Topics A–C

**Solve problems involving the four operations, and identify and explain patterns in arithmetic.**

- 3.OA.8** Solve two-step word problems using the four operations. Represent these problems using equations with a letter standing for the unknown quantity. Assess the reasonableness of answers using mental computation and estimation strategies including rounding. (This standard is limited to problems posed with whole numbers and having whole number answers; students should know how to perform operations in the conventional order when there are no parentheses to specify a particular order [Order of Operations].)

**Geometric measurement: recognize perimeter as an attribute of plane figures and distinguish between linear and area measures.**

- 3.MD.8** Solve real world and mathematical problems involving perimeters of polygons, including finding the perimeter given the side lengths, finding an unknown side length, and exhibiting rectangles with the same perimeter and different areas or with the same area and different perimeters.

**Reason with shapes and their attributes.**

- 3.G.1** Understand that shapes in different categories (e.g., rhombuses, rectangles, and others) may share attributes (e.g., having four sides), and that the shared attributes can define a larger category (e.g., quadrilaterals). Recognize rhombuses, rectangles, and squares as examples of quadrilaterals, and draw examples of quadrilaterals that do not belong to any of these subcategories.

## Evaluating Student Learning Outcomes

A Progression Toward Mastery is provided to describe steps that illuminate the gradually increasing understandings that students develop *on their way to proficiency*. In this chart, this progress is presented from left (Step 1) to right (Step 4). The learning goal for students is to achieve Step 4 mastery. These steps are meant to help teachers and students identify and celebrate what the students CAN do now and what they need to work on next.

A Progression Toward Mastery				
Assessment Task Item and Standards Assessed	STEP 1 Little evidence of reasoning without a correct answer.  (1 Point)	STEP 2 Evidence of some reasoning without a correct answer.  (2 Points)	STEP 3 Evidence of some reasoning with a correct answer or evidence of solid reasoning with an incorrect answer.  (3 Points)	STEP 4 Evidence of solid reasoning with a correct answer.  (4 Points)
1  3.G.1	Student answers one part correctly.	Student answers two parts correctly. OR Student answers all parts correctly, but there is no explanation in part (c).	Student answers all parts correctly, including explanations in part (c). Explanation in part (c) may include information that reveals a possible misconception about the properties of quadrilaterals (e.g., a statement that each shape has at least one set of sides that do not intersect).	Student answers all parts correctly. a. The trapezoid is circled. b. The rhombus and rectangle are crossed out. c. All three shapes are quadrilaterals. Explanation includes that they each have four sides.
2  3.G.1	Student answers one or fewer parts correctly.	Student answers two parts correctly.	Student correctly draws all three shapes and names the shape in part (a). Side lengths in parts (b) and (c) may or may not be labeled.	All answers are correct, and appropriate work is shown. Student: a. Draws and names a shape with four right angles (e.g., a rectangle). b. Draws and labels side lengths of a four-sided shape with no right angles and no equal sides. c. Draws and labels side lengths of a rhombus using triangles (may use more than two triangles).



## A Progression Toward Mastery

<p style="text-align: center;"><b>3</b></p> <p style="text-align: center;"><b>3.MD.8</b></p>	<p>Student answer is incorrect, and work demonstrates an entirely incorrect strategy (e.g., <math>5 \times 7</math>).</p> <p>OR</p> <p>Student gives only a correct answer with no other work shown.</p>	<p>Student answer may or may not be correct. Student work shows a strategy for solving that is unclear.</p>	<p>Student work demonstrates a strategy for solving that makes sense for the problem, but the answer may be incorrect because of a calculation error.</p>	<p>Student answers that Mr. Cooper uses 24 meters of fence. Student work demonstrates a strategy for solving that makes sense for the problem (e.g., a rectangular picture of the stall with side lengths appropriately labeled and an equation like <math>5 + 5 + 7 + 7 = 24</math> or <math>10 + 14 = 24</math>).</p>
<p style="text-align: center;"><b>4</b></p> <p style="text-align: center;"><b>3.OA.8</b></p>	<p>Student may or may not have a correct answer. Student work is missing in one or both parts.</p> <p>OR</p> <p>Student may or may not have a correct answer. Student work in both parts demonstrates a strategy or an equation that is inappropriate for the problem.</p>	<p>Student may or may not have a correct answer.</p> <p>a. Strategy may be unclear or inappropriate for the problem.</p> <p>b. Student answer may or may not include a letter for the unknown, and equation may not entirely match the problem.</p>	<p>Student answers at least one part correctly; an incorrect answer in one part is the result of a calculation error.</p> <p>AND</p> <p>a. Student work demonstrates a strategy appropriate to the problem.</p> <p>b. Student writes an appropriate equation(s) including a letter for the unknown.</p>	<p>Student answers are all correct, and appropriate work is shown.</p> <p>a. Student answers 42 feet of wood trim. Student work demonstrates a strategy appropriate to the problem (e.g., <math>10 + 10 + 8 + 8 + 3 + 3</math>.)</p> <p>b. Student answers that 24 more feet of wood trim are needed for the bedroom than for the closet. Student writes an appropriate equation(s) including a letter for the unknown (e.g., <math>8 + 10 + 10 + 5 = 33</math>, <math>33 - (3 + 3 + 3) = w</math>).</p>



## A Progression Toward Mastery

<p style="text-align: center;"><b>5</b></p> <p style="text-align: center;"><b>3.MD.8</b></p>	<p>Student answer is correct, but there is no work. OR Student work demonstrates an inappropriate strategy for the problem, and the answer is incorrect.</p>	<p>Student work demonstrates a strategy appropriate to the problem, but several calculation errors result in an incorrect answer.</p>	<p>Student answer may be incorrect due to a calculation error; however, the work demonstrates a strategy appropriate to the problem.</p>	<p>Student correctly answers that the perimeter is 52 inches. Student work demonstrates a strategy appropriate to the problem (e.g., student may use a combination of multiplication and addition to calculate the perimeter).</p>
<p style="text-align: center;"><b>6</b></p> <p style="text-align: center;"><b>3.MD.8</b></p>	<p>Student answer is correct, but there is no work. OR Student work demonstrates an inappropriate strategy for the problem, and the answer is incorrect.</p>	<p>Student work demonstrates a strategy appropriate to the problem, but several calculation errors result in an incorrect answer.</p>	<p>Student answer may be incorrect because of a calculation error. Student work demonstrates a strategy appropriate to the problem.</p>	<p>Student answers that Mrs. Gomez needs to build 85 feet of fence. Student work demonstrates a strategy appropriate to the problem (e.g., <math>10\text{ ft} + 15\text{ ft} = 25\text{ ft}</math> and <math>25\text{ ft} + 35\text{ ft} + 15\text{ ft} + 10\text{ ft} = 85\text{ feet}</math>, or <math>25\text{ ft} + 50\text{ ft} + 10\text{ ft} = 85\text{ feet}</math>).</p>

Name Gina

Date \_\_\_\_\_

1. Three shapes are shown below.
  - a. Circle the shape(s) with only one pair of parallel sides.
  - b. Cross out the shape(s) with two pairs of parallel sides.

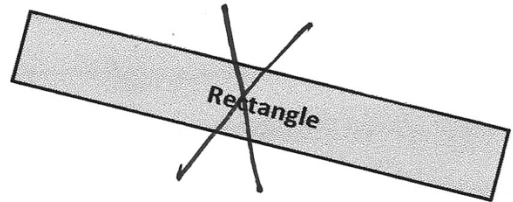
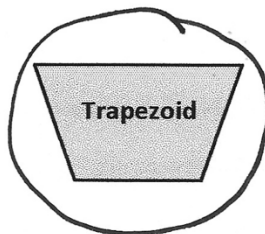
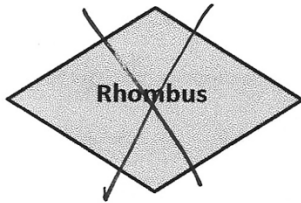

- c. Which of the three shapes are quadrilaterals? Explain how you know.

All three shapes are quadrilaterals because they each have four sides.



2. Use your ruler and right angle tool to draw the following shapes.
- a. Draw and name a shape with four right angles.

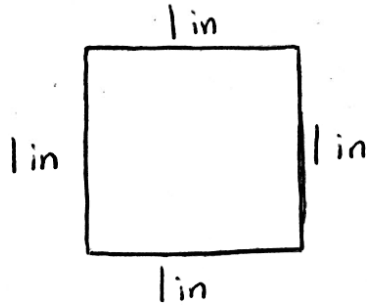

4 right angles and 4 equal sides

This is a square.

- b. Draw a four-sided shape with no right angles and no equal sides. Label the side lengths.

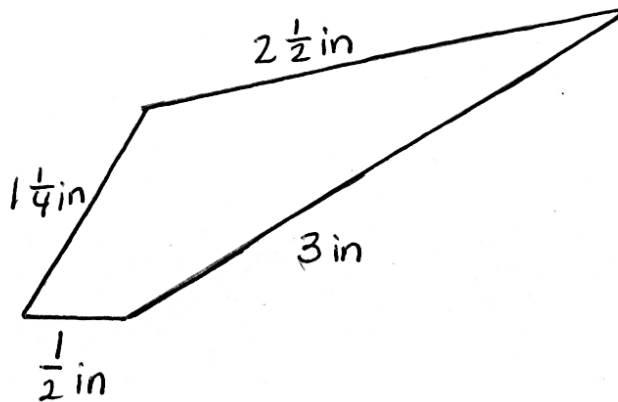

- c. Draw triangles to create a rhombus. Label the side lengths.

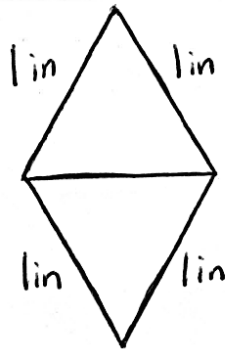

3. Mr. Cooper builds a fence to make a rectangular horse stall. The stall is 5 meters long and 7 meters wide. How many meters of fence does Mr. Cooper use? Draw a picture and write an equation to show your thinking.

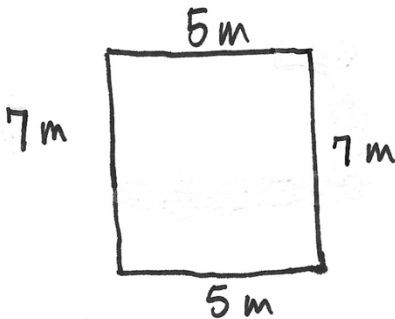

$$P = 5m + 5m + 7m + 7m$$

$$P = 24m$$

Mr. Cooper uses 24 meters of fence.

4. Jamal wants to put wood trim around his rectangular bedroom and square closet. His bedroom is 10 feet wide and 8 feet long. His closet is 3 feet wide and 3 feet long.

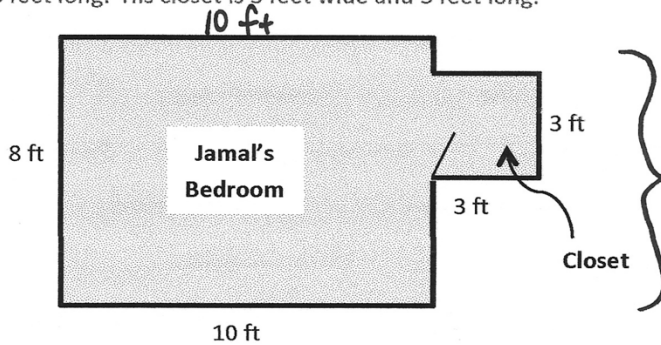

$$8\text{ ft} - 3\text{ ft} = 5\text{ ft}$$

- a. Wood trim is sold by the foot. How many feet of wood trim does Jamal need to go around his bedroom and closet? Show your work.

$$P = 8\text{ ft} + 10\text{ ft} + 10\text{ ft} + 8\text{ ft} + 3\text{ ft} + 3\text{ ft}$$

$\underbrace{10\text{ ft} + 10\text{ ft}}_{20\text{ ft}} \quad \underbrace{3\text{ ft} + 3\text{ ft}}_{6\text{ ft}}$

$$P = 16\text{ ft} + 20\text{ ft} + 6\text{ ft}$$

$$P = 42\text{ ft}$$

Jamal needs 42 feet of wood trim.

- b. How much more wood trim does Jamal need for his bedroom than his closet? Write and solve an equation. Use a letter to represent the unknown.

$$\text{Bedroom: } 8\text{ ft} + 10\text{ ft} + 10\text{ ft} + 5\text{ ft} = 33\text{ ft}$$

$$\text{Closet: } 3\text{ ft} + 3\text{ ft} + 3\text{ ft} = 9\text{ ft}$$

$$33\text{ ft} - 9\text{ ft} = W \quad W = 24\text{ ft}$$

He needs 24 more feet for the bedroom.

5. The figure below is composed of rectangles. Use the picture and the descriptions to find the perimeter of the shape. Show your work.

- Each side labeled with **A** is 6 inches.
- Each side labeled with **B** is 3 inches.
- Each side labeled with **C** is 8 inches.

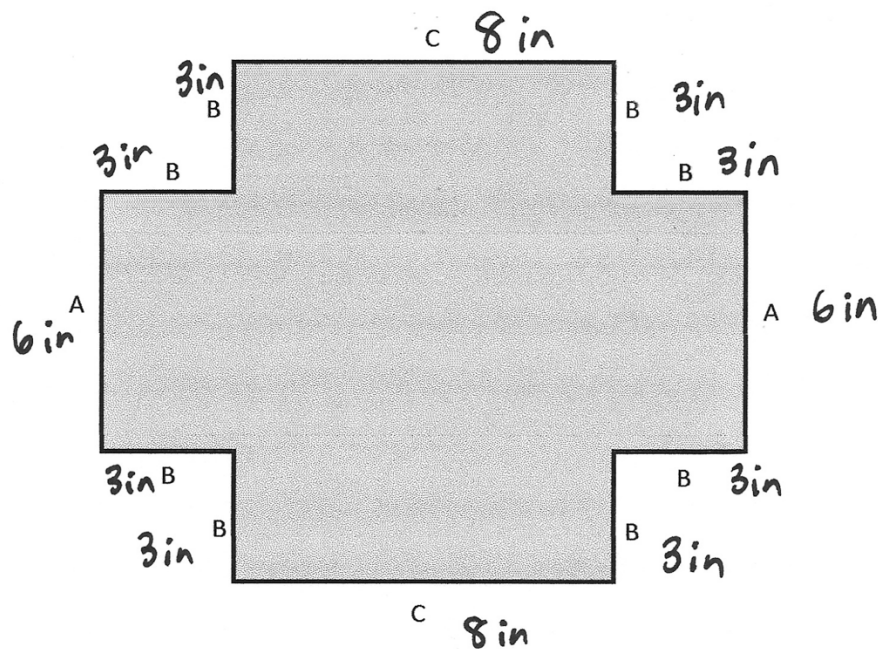

$$8 \text{ B's} = 8 \times 3 \text{ in} = 24 \text{ inches}$$

$$2 \text{ C's} = 2 \times 8 \text{ in} = 16 \text{ inches}$$

$$2 \text{ A's} = 2 \times 6 \text{ in} = 12 \text{ inches}$$

$$P = 24 \text{ in} + 16 \text{ in} + 12 \text{ in}$$

$$P = 52 \text{ in}$$

The perimeter is 52 inches.

6. Mrs. Gomez builds a fence around her backyard. Her plan shows the fence as a dotted line below.

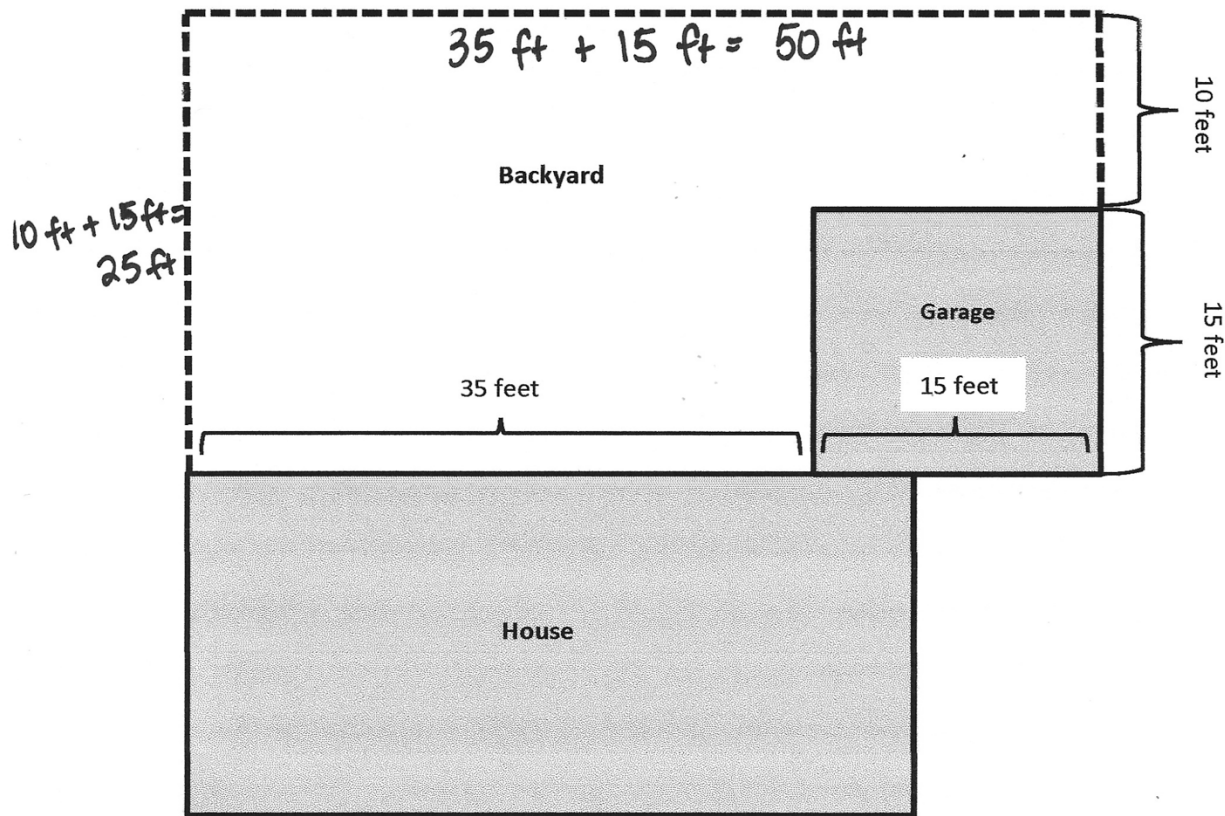

Together, the garage and backyard make a rectangle. The fence goes only where there is a dotted line. How many feet of fence does Mrs. Gomez need to build? Show your work.

$$25\text{ ft} + \underbrace{50\text{ ft} + 10\text{ ft}}_{60\text{ ft}} = 85\text{ ft}$$

Mrs. Gomez needs to build 85 feet of fence.



## Topic D

# Recording Perimeter and Area Data on Line Plots

**3.MD.4, 3.MD.8, 3.G.1**

<b>Focus Standards:</b>	3.MD.4	Generate measurement data by measuring lengths using rulers marked with halves and fourths of an inch. Show the data by making a line plot, where the horizontal scale is marked off in appropriate units—whole numbers, halves, or quarters.
	3.MD.8	Solve real world and mathematical problems involving perimeters of polygons, including finding the perimeter given the side lengths, finding an unknown side length, and exhibiting rectangles with the same perimeter and different areas or with the same area and different perimeters.
<b>Instructional Days:</b>	5	
<b>Coherence -Links from:</b>	G2–M6	Foundations of Multiplication and Division
	G3–M6	Collecting and Displaying Data
<b>-Links to:</b>	G4–M3	Multi-Digit Multiplication and Division

In Topic D, students utilize a line plot to draw conclusions about perimeter and area measurements.

Students use a given number of unit squares to build and determine different perimeters of rectangles in Lesson 18. For example, given a rectangle composed of 24 unit squares, students find there are four possible perimeters: 50, 28, 22, and 20 length units. They draw their rectangles on grid paper and discuss the fact that rectangles with side lengths that are equal or almost equal (squares or square-like rectangles) have smaller perimeters than rectangles whose side lengths are very different (long and narrow rectangles). Students continue to explore with different numbers of unit squares and record the number of possibilities, noting when they have found all the possible combinations. They recognize that area and perimeter are measured in different units and conclude that, in general, there is no way of knowing an exact perimeter for any number of unit squares without more information about the side lengths.

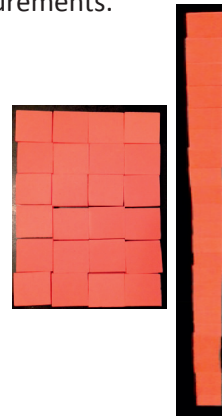

In Lesson 19, students use a given number of unit squares to make all possible rectangles. They construct line plots showing the number of rectangles they constructed for each number of unit squares. Students analyze the line plot and draw conclusions based on the data. They discuss why some numbers of unit squares, such as 13, produce only one possible perimeter.

Number of Rectangles Made with Unit Squares

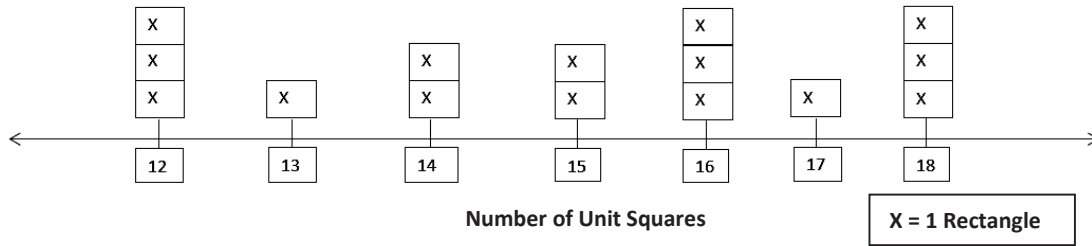

Using the understanding that perimeter is double the sum of the length and width, in Lessons 20 and 21, students find the different areas of rectangles made with unit squares and a given perimeter. For example, they are asked to build rectangles with a perimeter of 12 unit squares and divide 12 by 2 to find that the sum of the length and width is 6. Students then determine that they can make three rectangles whose lengths and widths add up to 6, which results in rectangles made with 5, 8, and 9 unit squares. Students discuss differences in the areas of rectangles with the same perimeter. They record their findings for use in Lesson 22, when they again construct a line plot and draw conclusions about the data.

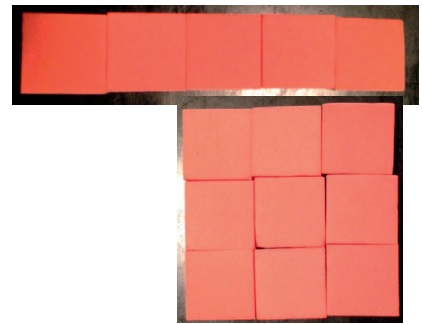

Number of Rectangles Made with a Given Perimeter

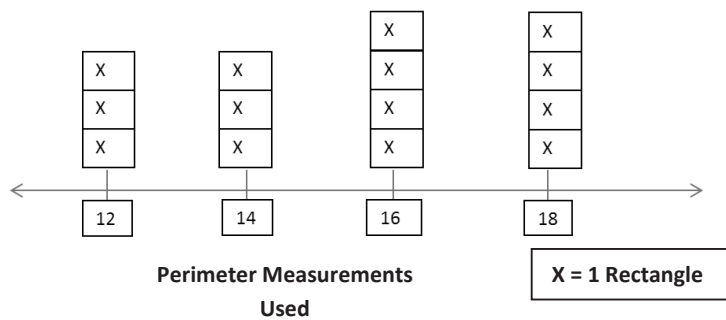

**A Teaching Sequence Toward Mastery of Recording Perimeter and Area Data on Line Plots**

**Objective 1:** Construct rectangles from a given number of unit squares and determine the perimeters.  
(Lesson 18)

**Objective 2:** Use a line plot to record the number of rectangles constructed from a given number of unit squares.  
(Lesson 19)

**Objective 3:** Construct rectangles with a given perimeter using unit squares and determine their areas.  
(Lessons 20–21)

**Objective 4:** Use a line plot to record the number of rectangles constructed in Lessons 20 and 21.  
(Lesson 22)

## Lesson 18

**Objective:** Construct rectangles from a given number of unit squares and determine the perimeters.

### Suggested Lesson Structure

■ Fluency Practice	(12 minutes)
■ Application Problem	(8 minutes)
■ Concept Development	(30 minutes)
■ Student Debrief	(10 minutes)
<b>Total Time</b>	<b>(60 minutes)</b>

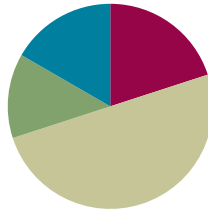

### Fluency Practice (12 minutes)

- Find the Unknown Factors **3.MD.7** (4 minutes)
- Draw Tape Diagrams **3.MD.7** (4 minutes)
- Find the Area and Perimeter **3.MD.8** (4 minutes)

### Find the Unknown Factors (4 minutes)

Materials: (S) Personal white board

Note: This activity prepares students for today's lesson.

T: (Project the unknown factor multiplication equations equaling 6, shown to the right.) On your personal white board, complete the unknown factors to create four different multiplication equations.

S: (Write  $1 \times 6 = 6$ ,  $2 \times 3 = 6$ ,  $3 \times 2 = 6$ ,  $6 \times 1 = 6$ .)

$$1 \times \underline{\quad} = 6$$

$$2 \times \underline{\quad} = 6$$

$$3 \times \underline{\quad} = 6$$

$$6 \times \underline{\quad} = 6$$

Continue with the following possible sequence of products: 8, 9, and 12.

### Draw Tape Diagrams (4 minutes)

Materials: (S) Personal white board

Note: This activity prepares students for today's lesson.

T: (Project a tape diagram with one small unit on the left and an open end on the right. Write 2 inside the small unit.) On your board, copy the diagram.

S: (Draw the diagram, and write 2 inside the small unit.)

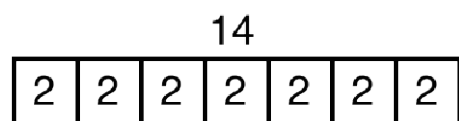



- T: (Write 14 at the top of the tape diagram.) Complete your diagram with equal units. Close the tape diagram when the total value of your units reaches 14.
- S: (Draw 6 more units of 2.)
- T: (Write  $\_\_ \times 2 = 14$ .) Say the multiplication sentence.
- S:  $7 \times 2 = 14$ .
- T: (Write  $2 \times \_\_ = 14$ .) Say the multiplication sentence.
- S:  $2 \times 7 = 14$ .

Continue with the following possible sequence: 8 units of 3, 4 units of 7, and 6 units of 9.

### Find the Area and Perimeter (4 minutes)

Materials: (S) Grid paper, personal white board

Note: This activity reviews Lesson 13.

- T: (Project a 2-unit by 4-unit rectangle.) What's the length of the rectangle?
- S: 4 units.
- T: (Write 4 units below the rectangle.) What's the width of the rectangle?
- S: 2 units.
- T: (Write 2 units to the right of the rectangle. Beneath it, write  $A = \_\_$ .) On your board, write the area.
- S: (Write  $A = 8$  square units.)
- T: (Write  $A = 8$  square units. Write  $P = \_\_$ .) Write the perimeter of the rectangle.
- S: (Write  $P = 12$  units.)

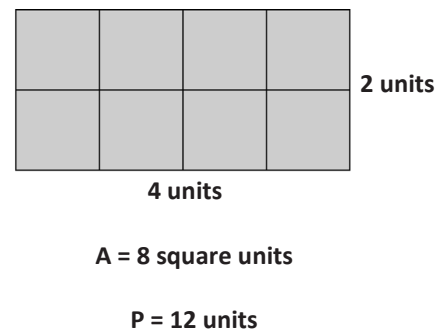

Continue with the following possible sequence: 4-unit by 3-unit rectangle, 2-unit by 6-unit rectangle, 4-unit by 4-unit square, 8-unit by 2-unit rectangle, and 3-unit by 6-unit rectangle.

### Application Problem (8 minutes)

Rita says that since 15 is larger than 12, she can draw more arrays to show 15 than she can to show 12. Is she correct? Model to solve.

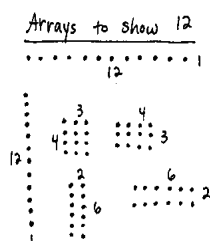
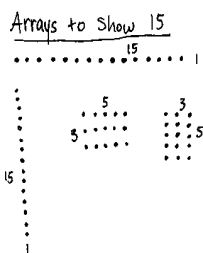

Rita is not correct. You can draw 6 arrays for 12, but only 4 arrays for 15. There are more arrays for 12 than 15.



#### NOTES ON MULTIPLE MEANS OF REPRESENTATION:

Students who find making dot arrays challenging may be supported by using grid paper to organize and track dots.

Note: This problem activates prior knowledge about determining factors that equal a specific product. This skill is needed in the Concept Development as students list all factors and then draw rectangles for a given area.

### Concept Development (30 minutes)

Materials: (S) Personal white board, grid paper (Template), 18 unit square tiles (per pair of students)

- T: With your partner, use unit square tiles to build as many rectangles as you can that have an area of 18 square units. Shade unit squares on your grid paper to represent each rectangle you build, and label the side lengths.
- S: (Build and shade the rectangles.)
- T: Talk to your partner. Can you build any other rectangles with your unit squares that have an area of 18 square units? How can you be sure?
- S: I think we got them all. We're really just building arrays, so we can think about multiplication facts. → We can list all the pairs of factors that make 18 when you multiply them. Then, we can check to make sure we have a rectangle for each pair of factors.
- T: Work with your partner to write all the multiplication facts you know for 18.
- S: (Write  $1 \times 18$ ,  $2 \times 9$ ,  $3 \times 6$ ,  $6 \times 3$ ,  $9 \times 2$ ,  $18 \times 1$ .)
- T: How many facts did you come up with, and what are they? (As students share facts, list them on the board.)
- S: 6 facts!
- T: How can you be sure you found them all?
- S: We started at 1 and thought, "1 times what equals 18?" We wrote down facts when we found ones that worked. We did that for every number up to 18. It's kind of like our Find the Unknown Factors fluency activity.
- T: Which of these facts are related through commutativity?
- S:  $1 \times 18$  and  $18 \times 1$ ,  $2 \times 9$  and  $9 \times 2$ ,  $3 \times 6$  and  $6 \times 3$ .
- T: If you ignore duplicates, how many rectangles can you build using these facts?
- S: 3.
- T: Check your work to be sure you found all the possible rectangles that you can make with your unit square tiles that have an area of 18 square units.
- S: (Check work and make adjustments, if necessary.)
- T: Your three rectangles look different. How do you know they have the same area?
- S: I used 18 unit squares to make each one. → When I multiply the side lengths, I get 18 for each of them.



#### NOTES ON MULTIPLE MEANS OF ACTION AND EXPRESSION:

Support English language learners by providing a word bank and allowing students to discuss their thoughts before writing on their Problem Sets.

Here is a possible sentence starter:  
"To find the perimeter, we need to know..."

Possible words for the word bank are given below:

length	width	rectangle
different	area	perimeter

T: Talk to a partner. Do you think our three rectangles also have the same perimeter?

S: (Discuss with partner.)

T: Find the perimeter for each rectangle.

S: (The perimeter of the 1 by 18 rectangle is 38 units, the perimeter of the 2 by 9 rectangle is 22 units, and the perimeter of the 3 by 6 rectangle is 18 units.)

T: Talk to your partner. Why do you think these rectangles have different perimeters?

S: The sides of the rectangles are all different lengths. → But why does that matter? They all have the same total number of square units! → But the squares are arranged differently. In the 1 by 18 rectangle, a lot of the sides on each unit square are part of the perimeter. That makes this rectangle have the greatest perimeter. → But in the 2 by 9 rectangle, most unit squares have only one side that is part of the perimeter. → I get it now. Like on the 3 by 6 rectangle, some unit squares aren't part of the perimeter at all because they're just stuck in the middle. That's why it has the smallest perimeter.

T: What is the relationship between the shape of the rectangle and the size of its perimeter?

S: Rectangles that are long and skinny have greater perimeters because more sides of each square are part of the perimeter. → You mean more sides of each square are counted as part of the perimeter. → Yeah, and that makes the numbers you add up greater. And that means a greater perimeter. → The ones that are wider and closer to being squares have some unit squares in the middle that don't have *any* sides that are part of the perimeter.

T: Compare the areas and perimeters of your rectangles. Do you see a connection between them?

S: The 3 by 6 rectangle has a perimeter of 18 units and an area of 18 square units. → But the other ones don't match at all, so area and perimeter don't go together all the time. → Yeah. That must've just been a coincidence that it matched up for the 18-square-unit rectangle.

MP.3

### Problem Set (10 minutes)

Students should do their personal best to complete the Problem Set within the allotted 10 minutes. For some classes, it may be appropriate to modify the assignment by specifying which problems they work on first. Some problems do not specify a method for solving. Students should solve these problems using the RDW approach used for Application Problems.

Example of Problem 1 Grid Paper

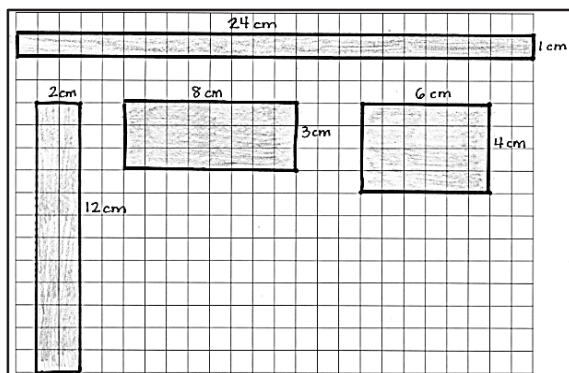

Note: Students need 24 unit square tiles and grid paper to complete the Problem Set.

## Student Debrief (10 minutes)

**Lesson Objective:** Construct rectangles from a given number of unit squares and determine the perimeters.

The Student Debrief is intended to invite reflection and active processing of the total lesson experience.

Invite students to review their solutions for the Problem Set. They should check work by comparing answers with a partner before going over answers as a class. Look for misconceptions or misunderstandings that can be addressed in the Debrief. Guide students in a conversation to debrief the Problem Set and process the lesson.

Any combination of the questions below may be used to lead the discussion.

- Explain your strategy for finding rectangles with an area of 24 square units in Problem 1.
- Why were you able to find more rectangles using 24 square units than you were using 18 square units?
- What do you notice about the relationship between a rectangle's shape and its perimeter in Problem 1(a)?
- Why were you able to find a square in Problem 2 but not in Problem 1?
- Share your answers to Problem 3.
- Why do you think a square has a smaller perimeter than any other rectangle with the same area?
- How did the Application Problem relate to today's lesson?
- How did today's Fluency Practice prepare you for today's lesson?

## Exit Ticket (3 minutes)

After the Student Debrief, instruct students to complete the Exit Ticket. A review of their work will help with assessing students' understanding of the concepts that were presented in today's lesson and planning more effectively for future lessons. The questions may be read aloud to the students.

Name Gina Date \_\_\_\_\_

1. Use unit squares to build as many rectangles as you can with an area of 24 square units. Shade in squares on your grid paper to represent each rectangle that you made with an area of 24 square units.

a. Estimate to draw and label the side lengths of each rectangle you built in Problem 1. Then find the perimeter of each rectangle. One rectangle is done for you.

24 units

1 unit

$P = 24 \text{ units} + 1 \text{ unit} + 24 \text{ units} + 1 \text{ unit} = 50 \text{ units}$

2 units

12 units

$P = 2 \text{ units} + 12 \text{ units} + 2 \text{ units} + 12 \text{ units}$   
 $P = 28 \text{ units}$

3 units

8 units

$P = 3 \text{ units} + 8 \text{ units} + 3 \text{ units} + 8 \text{ units}$   
 $P = 22 \text{ units}$

6 units

4 units

$P = 4 \text{ units} + 6 \text{ units} + 4 \text{ units} + 6 \text{ units}$   
 $P = 20 \text{ units}$

b. The areas of the rectangles in Problem 1(a) are all the same. What do you notice about the perimeters?  
Even though the areas are all the same, the perimeters are all different!

2. Use unit square tiles to build as many rectangles as you can with an area of 16 square units. Estimate to draw each rectangle below. Label the side lengths.

16 units

1 unit

$P = 16 \text{ units} + 1 \text{ unit} + 16 \text{ units} + 1 \text{ unit} = 34 \text{ units}$

2 units

8 units

$P = 2 \text{ units} + 8 \text{ units} + 2 \text{ units} + 8 \text{ units} = 20 \text{ units}$

4 units

4 units

$P = 4 \times 4 \text{ units}$   
 $P = 16 \text{ units}$

✓ a. Find the perimeters of the rectangles you built.

b. What is the perimeter of the square? Explain how you found your answer.  
The perimeter of the square is 16 units because the side lengths are all 4 units and a rectangle with 4 equal side lengths is a square.

3. Doug uses square unit tiles to build rectangles with an area of 35 square units. He draws the rectangles as shown below, but forgets to label the side lengths. Doug says that Rectangle A has a greater perimeter than Rectangle B. Do you agree? Why or why not?

Rectangle A

Rectangle B

Yes, I agree that Rectangle A has a greater perimeter because when rectangles have the same areas, the longer, skinnier rectangle has a greater perimeter.

Name \_\_\_\_\_

Date \_\_\_\_\_

1. Use unit squares to build as many rectangles as you can with an area of 24 square units. Shade in squares on your grid paper to represent each rectangle that you made with an area of 24 square units.
  - a. Estimate to draw and label the side lengths of each rectangle you built in Problem 1. Then, find the perimeter of each rectangle. One rectangle is done for you.

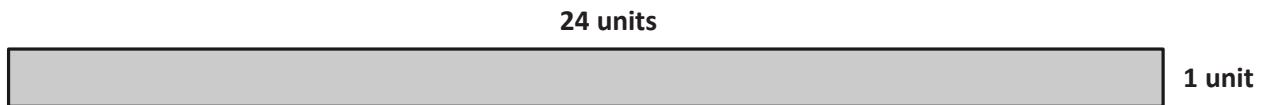

$$P = 24 \text{ units} + 1 \text{ unit} + 24 \text{ units} + 1 \text{ unit} = \underline{50 \text{ units}}$$

- b. The areas of the rectangles in part (a) above are all the same. What do you notice about the perimeters?

2. Use unit square tiles to build as many rectangles as you can with an area of 16 square units. Estimate to draw each rectangle below. Label the side lengths.

- a. Find the perimeters of the rectangles you built.
- b. What is the perimeter of the square? Explain how you found your answer.

3. Doug uses square unit tiles to build rectangles with an area of 15 square units. He draws the rectangles as shown below but forgets to label the side lengths. Doug says that Rectangle A has a greater perimeter than Rectangle B. Do you agree? Why or why not?



Name \_\_\_\_\_

Date \_\_\_\_\_

Tessa uses square-centimeter tiles to build rectangles with an area of 12 square centimeters. She draws the rectangles as shown below. Label the unknown side lengths of each rectangle. Then, find the perimeter of each rectangle.

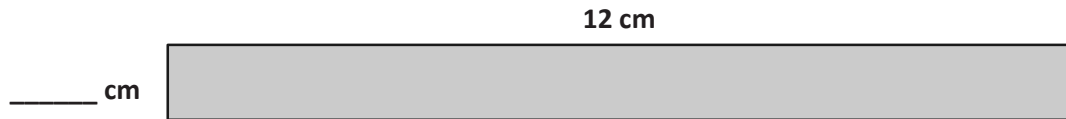

P = \_\_\_\_\_

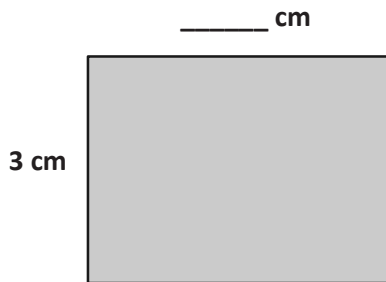

P = \_\_\_\_\_



P = \_\_\_\_\_

Name \_\_\_\_\_

Date \_\_\_\_\_

1. Shade in squares on the grid below to create as many rectangles as you can with an area of 18 square centimeters.

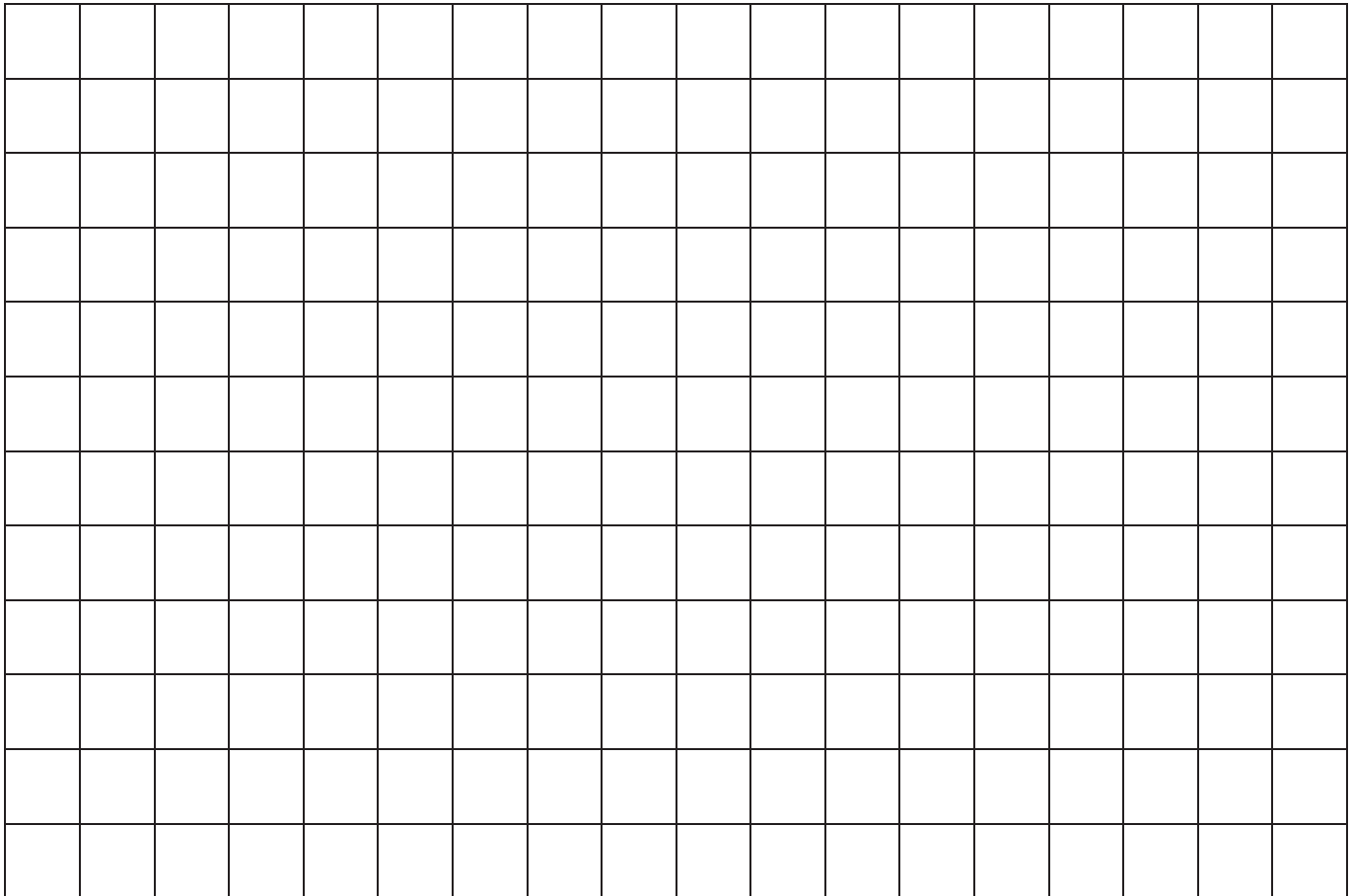

2. Find the perimeter of each rectangle in Problem 1 above.



3. Estimate to draw as many rectangles as you can with an area of 20 square centimeters. Label the side lengths of each rectangle.

a. Which rectangle above has the greatest perimeter? How do you know just by looking at its shape?

b. Which rectangle above has the smallest perimeter? How do you know just by looking at its shape?

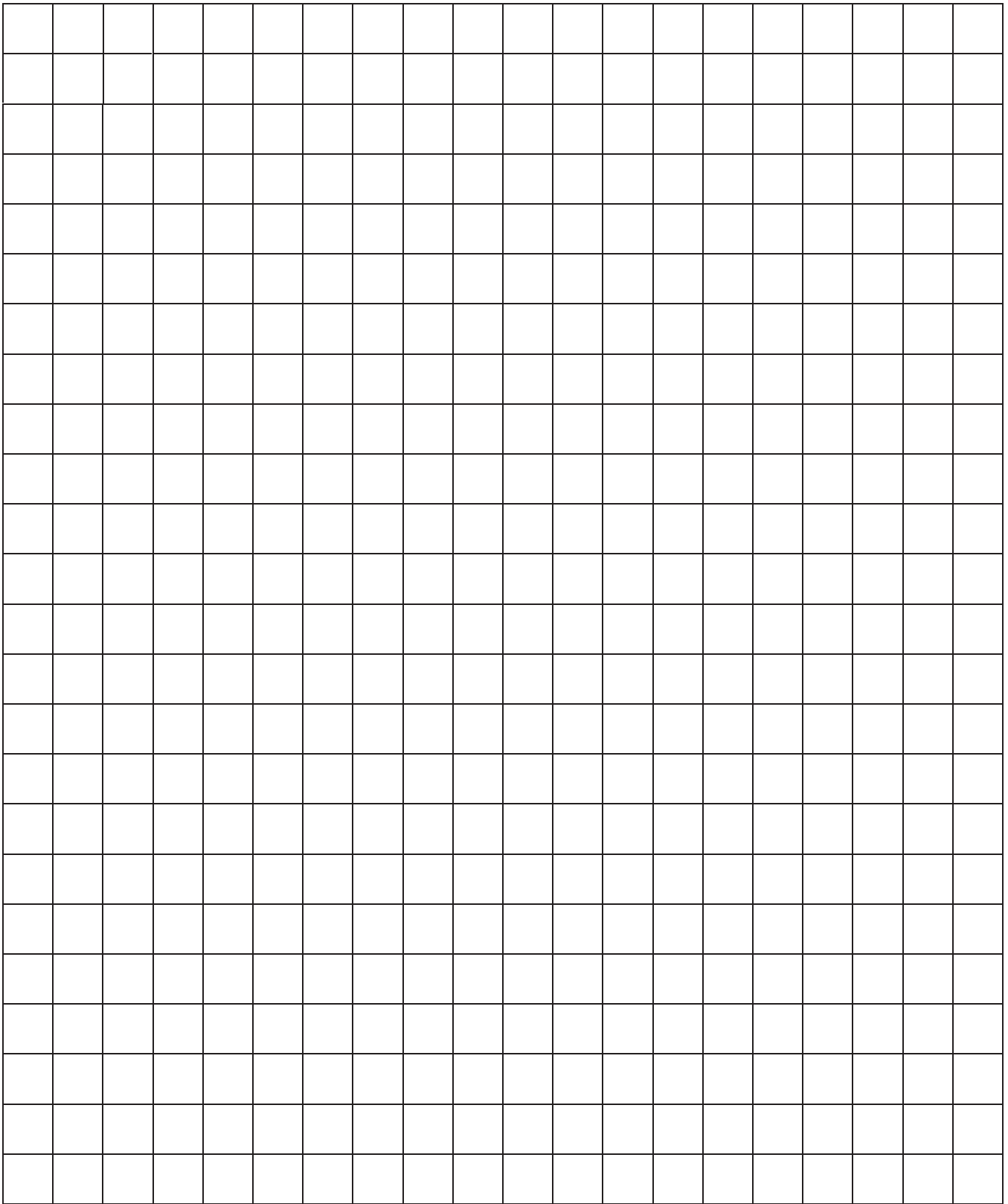

---

grid paper

## Lesson 19

**Objective:** Use a line plot to record the number of rectangles constructed from a given number of unit squares.

### Suggested Lesson Structure

■ Fluency Practice	(12 minutes)
■ Application Problem	(8 minutes)
■ Concept Development	(30 minutes)
■ Student Debrief	(10 minutes)
<b>Total Time</b>	<b>(60 minutes)</b>

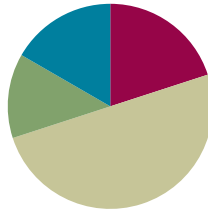

### Fluency Practice (12 minutes)

- Draw Tape Diagrams **3.MD.7** (6 minutes)
- Find the Perimeter **3.MD.8** (6 minutes)

### Draw Tape Diagrams (6 minutes)

Materials: (S) Personal white board

Note: This activity prepares students for today's lesson.

T: (Project a tape diagram that has a whole of 14 and a given part of 4.)  
What is the value of the whole?

S: 14.

T: (Point to the unknown part.) What's the value of the unknown part?

S: 10.

T: (Write 10 beneath the unknown part. Partition the unit of 10 into 2 equal parts.) Write the value of each unknown unit as a division sentence.

S: (Write  $10 \div 2 = 5$ .)

T: (Write 5 inside each unit.)

Repeat the process for the other tape diagrams.

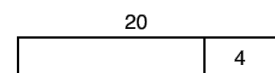
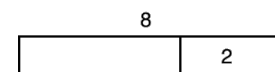
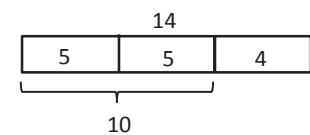
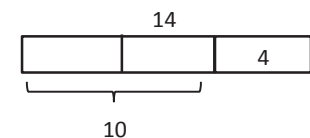
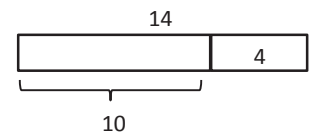

**Find the Perimeter (6 minutes)**

Materials: (S) Grid paper

Note: This activity reviews Lesson 18.

T: Shade rectangles that have an area of 6 square units.

S: (Shade a  $1 \times 6$  rectangle and a  $2 \times 3$  rectangle.)

T: Next to each rectangle, write the perimeter.

S: (Next to the  $1 \times 6$  rectangle, write  $P = 14$  units. Next to the  $2 \times 3$  rectangle, write  $P = 10$  units.)



Continue with the following possible sequence: 8 square units and 12 square units.

**Application Problem (8 minutes)**

Marci says, “If a rectangle has a greater area than another rectangle, it must have a larger perimeter.” Do you agree or disagree? Show an example to prove your thinking.

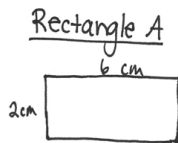

$$A = 2 \text{ cm} \times 6 \text{ cm}$$

$$A = 12 \text{ sq cm}$$

$$P = 2 \text{ cm} + 2 \text{ cm} + 6 \text{ cm} + 6 \text{ cm}$$

$$P = 4 \text{ cm} + 12 \text{ cm}$$

$$P = 16 \text{ cm}$$

I disagree with Marci. Rectangle A's area is greater than Rectangle B's area. But, Rectangle B has a greater perimeter than Rectangle A.

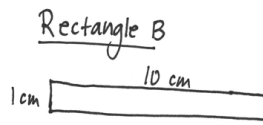

$$A = 1 \text{ cm} \times 10 \text{ cm}$$

$$A = 10 \text{ sq cm}$$

$$P = 1 \text{ cm} + 1 \text{ cm} + 10 \text{ cm} + 10 \text{ cm}$$

$$P = 2 \text{ cm} + 20 \text{ cm}$$

$$P = 22 \text{ cm}$$



**NOTES ON  
MULTIPLE MEANS  
OF ACTION AND  
EXPRESSION:**

Students working below grade level may find success manipulating unit square tiles to solve the Application Problem.

Note: This problem contributes to the growing number of examples that help students conclude that there is no relationship between area and perimeter. It also reviews using multiplication to calculate area, which students use in today's lesson.

## Concept Development (30 minutes)

Materials: (S) Personal white board, Problem Set, unit square tiles

Note: Save students' Problem Sets for use in Lesson 22.

### Part 1: Use unit square tiles to make rectangles with a given number of unit squares.

- T: Read the directions for Problem 1 on your Problem Set.
- S: (Read: Use unit square tiles to make rectangles for each given number of unit squares. Complete the charts to show how many rectangles you can make for each given number of unit squares. [12, 13, 14, 15, 16, 17, 18.] The first one is done for you. You might not use all the spaces in each chart.)
- T: Look at the completed chart for 12 unit squares. It shows a 1 by 12 rectangle. Talk to a partner. Why doesn't the chart also list a 12 by 1 rectangle?
- S: They're really the same rectangle, just turned.
- T: How do we know the chart shows all the rectangles that we can make with our 12 unit square tiles?
- S: We can list the multiplication facts that equal 12 and check to make sure they're on the chart.
- T: Work with a partner and use your unit square tiles to make as many rectangles as you can for each given number of unit squares. Record the widths and lengths of the rectangles in the charts.

Once students have completed Problem 1, take a few minutes to review the data to be sure that everyone has the correct information because it is used in Part 2 of this lesson.

### Part 2: Create a line plot to display how many rectangles can be made with a given number of unit squares.

- T: Let's record our data on the line plot in Problem 2. (Create a line plot with the data collected in Problem 1.)
- T: What symbol will we use to represent a rectangle on our line plot? How do you know?
- S: We'll use an X. I know because the key says an X equals 1 rectangle.
- T: Is the number line in Problem 2 fully labeled and ready to have data plotted?
- S: No!
- T: What's missing?
- S: The numbers between 12 and 18.
- T: Which numbers do we need to add?
- S: We need to add 13, 14, 15, 16, and 17.
- T: Add those numbers to the number line. Estimate to make equal spaces between numbers.
- S: (Add the missing numbers.)

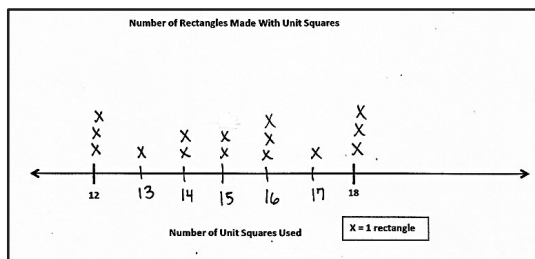

#### NOTES ON MULTIPLE MEANS OF ACTION AND EXPRESSION:

Ease the task of estimating to make equal spaces between numbers on the number line for students working below grade level and others. Direct students to estimate and draw the midpoint first, if helpful. Use of grid paper and colored pencils may also be helpful.

- T: Tell your partner how you'll record the data for 12 unit squares on the line plot.
- S: There were three possible rectangles for 12 unit squares, so I'll draw 3 X's above the number 12.
- T: Go ahead and do that now. Then, plot the data for each of the other numbers of unit squares, too. (Allow students time to work.)
- T: Study your line plot, and think about a true statement to share with others about the data. (Allow students time to think of a statement.)
- S: 13 and 17 had the least number of rectangles. 12, 16, and 18 had the most. → 14 and 15 had the same number of possible rectangles. → You can make 15 total rectangles using the given numbers of unit squares. → None of the odd numbers had the greatest number of rectangles.
- T: Why do you think 12, 16, and 18 unit squares have the largest possible number of rectangles?
- S: Because there are more factor pairs that make those numbers than the other ones.
- T: Talk to a partner. Why do you think 13 and 17 unit squares have the least possible rectangles?
- S: 13 and 17 had the least because they can both make only one rectangle. → The only two numbers that multiply to get 13 are 1 and 13. And the only two numbers that multiply to get 17 are 1 and 17.
- T: Record your thinking on Problems 3 and 4 of your Problem Set.

Consider extending the activity by asking students to find and then plot data for numbers greater than 18 unit squares.

### Student Debrief (10 minutes)

**Lesson Objective:** Use a line plot to record the number of rectangles constructed from a given number of unit squares.

The Student Debrief is intended to invite reflection and active processing of the total lesson experience.

Invite students to review their solutions for the Problem Set. They should check work by comparing answers with a partner before going over answers as a class. Look for misconceptions or misunderstandings that can be addressed in the Debrief. Guide students in a conversation to debrief the Problem Set and process the lesson.

Any combination of the questions below may be used to lead the discussion.

- For which number of unit squares in Problem 1 can a square be drawn? How do you know? Can you brainstorm other numbers of unit squares from which a square can be drawn? Can you think of other numbers of unit squares, like 13 and 17, that only have one possible rectangle? How did you come up with them?

Name: Gina Date: \_\_\_\_\_

1. Use unit square tiles to make rectangles for each given number of unit squares. Complete the charts to show how many rectangles you can make for each given number of unit squares. The first one is done for you. You might not use all the spaces in each chart.

Number of unit squares = 12	
Number of rectangles I made: <u>3</u>	
Width	Length
1	12
2	6
3	4

Number of unit squares = 13	
Number of rectangles I made: <u>1</u>	
Width	Length
1	13

Number of unit squares = 14	
Number of rectangles I made: <u>2</u>	
Width	Length
1	14
2	7

Number of unit squares = 15	
Number of rectangles I made: <u>2</u>	
Width	Length
1	15
3	5

Number of unit squares = 16	
Number of rectangles I made: <u>3</u>	
Width	Length
1	16
2	8
4	4

Number of unit squares = 17	
Number of rectangles I made: <u>1</u>	
Width	Length
1	17

Number of unit squares = 18	
Number of rectangles I made: <u>3</u>	
Width	Length
1	18
2	9
3	6

- Can you think of a number of unit squares that would allow us to make four rectangles? What's the smallest number for which this is true?
- How is the number of unit squares used to make a rectangle related to the rectangle's area? How do you know?

### Exit Ticket (3 minutes)

After the Student Debrief, instruct students to complete the Exit Ticket. A review of their work will help with assessing students' understanding of the concepts that were presented in today's lesson and planning more effectively for future lessons. The questions may be read aloud to the students.

2. Create a line plot with the data you collected in Problem 1.

Number of Rectangles Made With Unit Squares

Number of Unit Squares Used	Number of Rectangles (X's)
12	3
13	1
14	2
15	2
16	3
17	1
18	3

3. Which numbers of unit squares produce 3 rectangles?

*12, 16, and 18 unit squares all produce 3 rectangles.*

4. Why do some numbers of unit squares, such as 13, only produce one rectangle?

*Some numbers of unit squares only produce 1 rectangle because there is only one pair of factors that can multiply to make that number. Like 13 only has 1 and 13.*

Name \_\_\_\_\_

Date \_\_\_\_\_

1. Use unit square tiles to make rectangles for each given number of unit squares. Complete the charts to show how many rectangles you can make for each given number of unit squares. The first one is done for you. You might not use all the spaces in each chart.

Number of unit squares = <b>12</b>	
Number of rectangles I made: <u>3</u>	
Width	Length
1	12
2	6
3	4

Number of unit squares = <b>13</b>	
Number of rectangles I made: ____	
Width	Length

Number of unit squares = <b>14</b>	
Number of rectangles I made: ____	
Width	Length

Number of unit squares = <b>15</b>	
Number of rectangles I made: ____	
Width	Length

Number of unit squares = <b>16</b>	
Number of rectangles I made: ____	
Width	Length

Number of unit squares = <b>17</b>	
Number of rectangles I made: ____	
Width	Length

Number of unit squares = <b>18</b>	
Number of rectangles I made: ____	
Width	Length



2. Create a line plot with the data you collected in Problem 1.

**Number of Rectangles Made with Unit Squares**

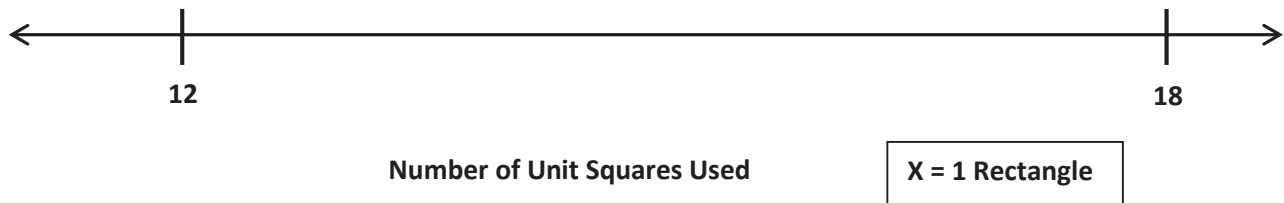

3. Which numbers of unit squares produce three rectangles?
4. Why do some numbers of unit squares, such as 13, only produce one rectangle?

Name \_\_\_\_\_

Date \_\_\_\_\_

Use unit square tiles to make rectangles for the given number of unit squares. Complete the chart to show how many rectangles you made for the given number of unit squares. You might not use all the spaces in the chart.

Number of unit squares = <b>20</b>	
Number of rectangles I made: ____	
Width	Length

Name \_\_\_\_\_

Date \_\_\_\_\_

1. Cut out the unit squares at the bottom of the page. Then, use them to make rectangles for each given number of unit squares. Complete the charts to show how many rectangles you can make for each given number of unit squares. You might not use all the spaces in each chart.

Number of unit squares = <b>6</b>	
Number of rectangles I made: _____	
Width	Length

Number of unit squares = <b>7</b>	
Number of rectangles I made: _____	
Width	Length

Number of unit squares = <b>8</b>	
Number of rectangles I made: _____	
Width	Length

Number of unit squares = <b>9</b>	
Number of rectangles I made: _____	
Width	Length

Number of unit squares = <b>10</b>	
Number of rectangles I made: _____	
Width	Length

Number of unit squares = <b>11</b>	
Number of rectangles I made: _____	
Width	Length

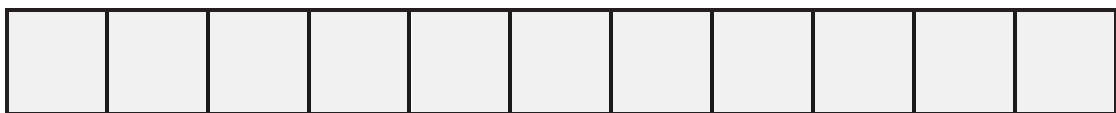

2. Create a line plot with the data you collected in Problem 1.

**Number of Rectangles Made with Unit Squares**



- a. Luke looks at the line plot and says that all odd numbers of unit squares produce only 1 rectangle. Do you agree? Why or why not?
- b. How many X's would you plot for 4 unit squares? Explain how you know.

## Lesson 20

**Objective:** Construct rectangles with a given perimeter using unit squares and determine their areas.

### Suggested Lesson Structure

■ Fluency Practice	(10 minutes)
■ Application Problem	(7 minutes)
■ Concept Development	(33 minutes)
■ Student Debrief	(10 minutes)
<b>Total Time</b>	<b>(60 minutes)</b>

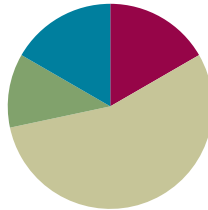

### Fluency Practice (10 minutes)

- Sprint: Multiply or Divide by 2 **3.OA.7** (10 minutes)

### Sprint: Multiply or Divide by 2 (10 minutes)

Materials: (S) Multiply or Divide by 2 Sprint

Note: This Sprint builds fluency with multiplication and division facts using units of 2.

### Application Problem (7 minutes)

Molly builds a rectangular playpen for her pet rabbit. The playpen has an area of 15 square yards.

- Estimate to draw and label as many possibilities as you can for the playpen.
- Find the perimeters of the rectangles in part (a).
- What other information do you need in order to re-create Molly's playpen?

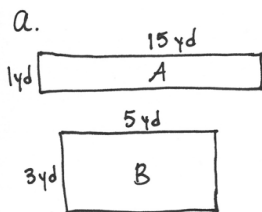

b.

$$\begin{aligned} \text{Perimeter of A} &= 1\text{ yd} + 1\text{ yd} + 15\text{ yd} + 15\text{ yd} \\ &= 2\text{ yd} + 30\text{ yd} \\ &= 32\text{ yd} \\ \text{Perimeter of B} &= 5\text{ yd} + 5\text{ yd} + 3\text{ yd} + 3\text{ yd} \\ &= 10\text{ yd} + 6\text{ yd} \\ &= 16\text{ yd} \end{aligned}$$

c. I would need to know one of the side lengths to know which playpen Molly built. Or, I could use my answers to part (b) to figure out which playpen she built if she told me the playpen's perimeter.

Note: This reviews the concepts learned in Lessons 18 and 19. Consider inviting students to discuss whether or not one of the rectangles from part (a) would be preferred as an outdoor playpen for a rabbit.

### Concept Development (33 minutes)

Materials: (S) Problem Set, personal white board, square unit tiles

Note: Today's lesson includes two strategies for finding the length and width of a rectangle when the perimeter is known. One strategy is written into the vignette, and the other is explained after the vignette. Before delivering the lesson, read through both, and decide which is most appropriate for the class. Depending on the class, both may be taught.

- T: Read the first sentence in Problem 1.
- S: (Read: Use your square unit tiles to build as many rectangles as you can with a perimeter of 12 units.)
- T: How is this problem different from the work we've been doing the past few days?
- S: Before, we knew the area of the rectangle and had to find length and width. Now we need to use the perimeter to find the length and width.
- T: When we knew the area, we used pairs of factors to help us find length and width. What strategy might we use to help us when we know the perimeter?
- S: We have to build or draw rectangles with different lengths and widths and see if the perimeter is 12 units.  
→ That could take a long time.
- T: Let's see what we can figure out. (Project the labeled rectangle and equation shown to the right.) Discuss with a partner how this equation represents the perimeter of the rectangle.
- S: (Discuss.)
- T: Solve the addition fact, and rewrite the equation using the sum.
- S: (Write  $P = 2 \times 11$  cm.)
- T: When we multiply a number by 2, what are we doing to that number?
- S: Doubling it!
- T: So, this equation shows perimeter as double the sum of the width and length. Talk to a partner. Can the perimeter of all rectangles be written as double the sum of the width and length?
- S: Yes, because all rectangles have opposite sides that are equal.
- T: Let's see how knowing that helps with Problem 1. It asks us to use unit squares to build as many rectangles as we can that have a perimeter of 12 units. We know that the perimeter, 12 units, is double the sum of the width and length. What is the opposite of doubling a number?
- S: Dividing a number by 2. → Halving a number.



#### NOTES ON MULTIPLE MEANS OF ACTION AND EXPRESSION:

Offer students the option of using a 12-centimeter or 12-inch piece of string or wire (rather than square tiles) to build rectangles with a perimeter of 12 units in Problem 1 of the Problem Set.

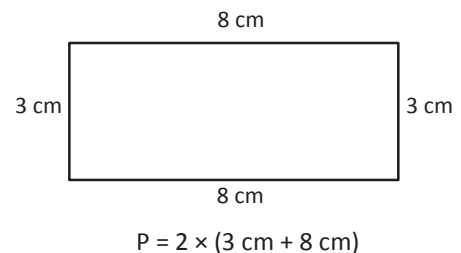

MP.5

MP.5

- T: (Write the equation  $12 \div 2 = 6$ .) What does the 6 in this equation represent in relation to a rectangle with a perimeter of 12?
- S: You divided the perimeter by 2, so 6 is the sum of the width and length.  $\rightarrow$  You halved the perimeter, and 6 is the sum of the width and length.
- T: Now that we know the sum of the width and length, we can find pairs of numbers that add up to 6. Start at 1, and work with a partner to write number sentences that have a sum of 6. You only need to include a combination once.
- S: (Write  $1 + 5 = 6$ ,  $2 + 4 = 6$ , and  $3 + 3 = 6$ .)
- T: (Write the number sentences.) Check your work with mine, and make changes, if necessary. (Allow students time to check work.) What do these combinations represent?
- S: They're the possible widths and lengths for a rectangle with a perimeter of 12 units!  $\rightarrow$  Wait. How do we know which is width and which is length?
- T: Sketch a rectangle one way, and then trade the numbers that go with width and length, and sketch again. What happens?
- S: Oh! It's the same rectangle, just flipped.  $\rightarrow$  I guess it doesn't matter which is which for now.
- T: Use your unit squares to build each rectangle with the widths and lengths that we found. Confirm that the perimeter is 12 units each time. Then, complete Problem 1 on the Problem Set.
- S: (Build rectangles and then complete Problem 1.)
- T: At the beginning of our lesson, we wondered which strategy we could use to find the width and length of a rectangle when we know the perimeter. Retell this strategy to your partner.
- S: (Discuss.)

## Sample Teacher's Board:

$$12 \div 2 = 6$$

$$1 + 5 = 6$$

$$2 + 4 = 6$$

$$3 + 3 = 6$$



### NOTES ON MULTIPLE MEANS OF REPRESENTATION:

When using square tiles to build rectangles of a certain perimeter, clarify the unit being counted. Students count unit squares to find area and count unit side lengths to find perimeter.

#### Alternative (or Additional) Strategy:

If appropriate for the class, consider teaching the following strategy instead of, or in addition to, the strategy demonstrated above. While this strategy has more steps than the strategy in the vignette, it does not require students to know or figure out half of the perimeter. Finding half of the perimeter can become tricky when students start to work with larger perimeters. As noted above, use discretion when deciding which strategy is appropriate for the class.

- Start with the same 3 cm by 8 cm rectangle as in the vignette.
- Show the equation  $P = (2 \times 3 \text{ cm}) + (2 \times 8 \text{ cm})$ . Ask students how the equation represents the perimeter of the rectangle.
- Students see that the equation shows the perimeter as the sum of double the width and double the length.
- Knowing that, students can start at 1 and double numbers until they get to the given perimeter. Then, they can find pairs of doubles that add up to the perimeter.

- These pairs of doubles represent double the widths and lengths, so students have to divide each number by 2 to get the widths and lengths.

For example, given a perimeter of 22 centimeters, students could find possible side lengths as shown below.

P = 22 cm	
Doubles: 2, 4, 6, 8, 10, 12, 14, 16, 18, 20, 22	
Pairs of Doubles That Add to 22:	Half of These Doubles:
2 + 20	w = 1, l = 10
4 + 18	w = 2, l = 9
6 + 16	w = 3, l = 8
8 + 14	w = 4, l = 7
10 + 12	w = 5, l = 6

### Problem Set (10 minutes)

Students should do their personal best to complete the Problem Set within the allotted 10 minutes. For some classes, it may be appropriate to modify the assignment by specifying which problems they work on first. Some problems do not specify a method for solving. Students should solve these problems using the RDW approach used for Application Problems.

To prepare for Lesson 22, students should add their data from today's lesson to the sheet shown to the right. (A master copy is included at the end of this lesson.) Data will need to be collected on the same sheet again at the end of Lesson 21. An extra five minutes is built into the time allotted for the Concept Development to accommodate this. However, choose when the data collection might happen most smoothly for the class, perhaps at the end of the Problem Set or the Student Debrief or after completing the Exit Ticket.

Name \_\_\_\_\_ Date \_\_\_\_\_

Use the data you gathered from Problem Sets 20 and 21 to complete the charts to show how many rectangles you can create with a given perimeter. You might not use all the spaces in the charts.

Perimeter = 10 units			Perimeter = 12 units		
Number of rectangles you made: _____			Number of rectangles you made: _____		
Width	Length	Area	Width	Length	Area
1 unit	4 units	4 square units			

Perimeter = 14 units			Perimeter = 16 units		
Number of rectangles you made: _____			Number of rectangles you made: _____		
Width	Length	Area	Width	Length	Area

Perimeter = 18 units			Perimeter = 20 units		
Number of rectangles you made: _____			Number of rectangles you made: _____		
Width	Length	Area	Width	Length	Area



## Student Debrief (10 minutes)

**Lesson Objective:** Construct rectangles with a given perimeter using unit squares and determine their areas.

The Student Debrief is intended to invite reflection and active processing of the total lesson experience.

Invite students to review their solutions for the Problem Set. They should check work by comparing answers with a partner before going over answers as a class. Look for misconceptions or misunderstandings that can be addressed in the Debrief. Guide students in a conversation to debrief the Problem Set and process the lesson.

Any combination of the questions below may be used to lead the discussion.

- Share your answers to Problem 1 (c) and (d). Why are the areas of the rectangles different, even though the perimeters are the same?
- What are the widths and lengths of the rectangles you drew in Problem 2(a)? Explain to a partner how you found the widths and lengths.
- Share your answer to Problem 2(c) with a partner. Why can't you find the area of a rectangle when you only know the rectangle's perimeter?
- Look at the rectangles you drew in Problems 1(a) and 2(a). Which perimeter allowed you to draw a square? How do you know?

## Exit Ticket (3 minutes)

After the Student Debrief, instruct students to complete the Exit Ticket. A review of their work will help with assessing students' understanding of the concepts that were presented in today's lesson and planning more effectively for future lessons. The questions may be read aloud to the students.

Name Gina Date \_\_\_\_\_

1. Use your square unit tiles to build as many rectangles as you can with a perimeter of 12 units.

a. Estimate to draw your rectangles below. Label the side lengths of each rectangle.

b. Explain your strategy for finding rectangles with a perimeter of 12 units.  
First I divided the perimeter by 2 to get 6. Then I found pairs of numbers that added to 6. These pairs of numbers are the possible widths and lengths.

c. Find the areas of all the rectangles in Part (a) above.

Area of Rectangle A = 1 unit  $\times$  5 units = 5 sq units

Area of Rectangle B = 3 units  $\times$  3 units = 9 sq units

Area of Rectangle C = 2 units  $\times$  4 units = 8 sq units

d. The perimeters of all the rectangles are the same. What do you notice about their areas?  
The areas of the rectangles are different!

2. Use your square unit tiles to build as many rectangles as you can with a perimeter of 14 units.

a. Estimate to draw your rectangles below. Label the side lengths of each rectangle.

b. Find the areas of all the rectangles in Part (a) above.

Area of Rectangle A = 1 unit  $\times$  6 units = 6 sq units

Area of Rectangle B = 2 units  $\times$  5 units = 10 sq units

Area of Rectangle C = 3 units  $\times$  4 units = 12 sq units

c. Given a rectangle's perimeter, what other information do you need to know about the rectangle to find its area?  
Given a rectangle's perimeter, you also need to know the width or length of the rectangle to find its area. For example, in the rectangles above, the perimeters are all the same, 14 units, but the areas are different.

## A

Number Correct: \_\_\_\_\_

Multiply or Divide by 2

1.	$2 \times 2 =$	
2.	$3 \times 2 =$	
3.	$4 \times 2 =$	
4.	$5 \times 2 =$	
5.	$1 \times 2 =$	
6.	$4 \div 2 =$	
7.	$6 \div 2 =$	
8.	$10 \div 2 =$	
9.	$2 \div 1 =$	
10.	$8 \div 2 =$	
11.	$6 \times 2 =$	
12.	$7 \times 2 =$	
13.	$8 \times 2 =$	
14.	$9 \times 2 =$	
15.	$10 \times 2 =$	
16.	$16 \div 2 =$	
17.	$14 \div 2 =$	
18.	$18 \div 2 =$	
19.	$12 \div 2 =$	
20.	$20 \div 2 =$	
21.	$\underline{\quad} \times 2 = 10$	
22.	$\underline{\quad} \times 2 = 12$	

23.	$\underline{\quad} \times 2 = 20$	
24.	$\underline{\quad} \times 2 = 4$	
25.	$\underline{\quad} \times 2 = 6$	
26.	$20 \div 2 =$	
27.	$10 \div 2 =$	
28.	$2 \div 1 =$	
29.	$4 \div 2 =$	
30.	$6 \div 2 =$	
31.	$\underline{\quad} \times 2 = 12$	
32.	$\underline{\quad} \times 2 = 14$	
33.	$\underline{\quad} \times 2 = 18$	
34.	$\underline{\quad} \times 2 = 16$	
35.	$14 \div 2 =$	
36.	$18 \div 2 =$	
37.	$12 \div 2 =$	
38.	$16 \div 2 =$	
39.	$11 \times 2 =$	
40.	$22 \div 2 =$	
41.	$12 \times 2 =$	
42.	$24 \div 2 =$	
43.	$14 \times 2 =$	
44.	$28 \div 2 =$	

## B

Number Correct: \_\_\_\_\_

Improvement: \_\_\_\_\_

Multiply or Divide by 2

1.	$1 \times 2 =$	
2.	$2 \times 2 =$	
3.	$3 \times 2 =$	
4.	$4 \times 2 =$	
5.	$5 \times 2 =$	
6.	$6 \div 2 =$	
7.	$4 \div 2 =$	
8.	$8 \div 2 =$	
9.	$2 \div 1 =$	
10.	$10 \div 2 =$	
11.	$10 \times 2 =$	
12.	$6 \times 2 =$	
13.	$7 \times 2 =$	
14.	$8 \times 2 =$	
15.	$9 \times 2 =$	
16.	$14 \div 2 =$	
17.	$12 \div 2 =$	
18.	$16 \div 2 =$	
19.	$20 \div 2 =$	
20.	$18 \div 2 =$	
21.	$\underline{\quad} \times 2 = 12$	
22.	$\underline{\quad} \times 2 = 10$	

23.	$\underline{\quad} \times 2 = 4$	
24.	$\underline{\quad} \times 2 = 20$	
25.	$\underline{\quad} \times 2 = 6$	
26.	$4 \div 2 =$	
27.	$2 \div 1 =$	
28.	$20 \div 2 =$	
29.	$10 \div 2 =$	
30.	$6 \div 2 =$	
31.	$\underline{\quad} \times 2 = 12$	
32.	$\underline{\quad} \times 2 = 16$	
33.	$\underline{\quad} \times 2 = 18$	
34.	$\underline{\quad} \times 2 = 14$	
35.	$16 \div 2 =$	
36.	$18 \div 2 =$	
37.	$12 \div 2 =$	
38.	$14 \div 2 =$	
39.	$11 \times 2 =$	
40.	$22 \div 2 =$	
41.	$12 \times 2 =$	
42.	$24 \div 2 =$	
43.	$13 \times 2 =$	
44.	$26 \div 2 =$	

Name \_\_\_\_\_

Date \_\_\_\_\_

1. Use your square unit tiles to build as many rectangles as you can with a perimeter of 12 units.
  - a. Estimate to draw your rectangles below. Label the side lengths of each rectangle.

- b. Explain your strategy for finding rectangles with a perimeter of 12 units.

- c. Find the areas of all the rectangles in part (a) above.

- d. The perimeters of all the rectangles are the same. What do you notice about their areas?



Name \_\_\_\_\_

Date \_\_\_\_\_

Use your square unit tiles to build as many rectangles as you can with a perimeter of 8 units.

- a. Estimate to draw your rectangles below. Label the side lengths of each rectangle.

- b. Find the areas of the rectangles in part (a) above.

Name \_\_\_\_\_

Date \_\_\_\_\_

1. Cut out the unit squares at the bottom of the page. Then, use them to make as many rectangles as you can with a perimeter of 10 units.
  - a. Estimate to draw your rectangles below. Label the side lengths of each rectangle.

- b. Find the areas of the rectangles in part (a) above.



2. Gino uses unit square tiles to make rectangles with a perimeter of 14 units. He draws his rectangles as shown below. Using square unit tiles, can Gino make another rectangle that has a perimeter of 14 units? Explain your answer.

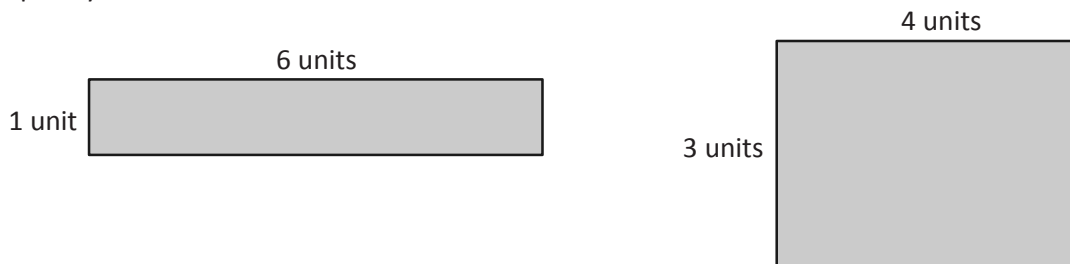

3. Katie draws a square that has a perimeter of 20 centimeters.
- Estimate to draw Katie's square below. Label the length and width of the square.
  - Find the area of Katie's square.
  - Estimate to draw a different rectangle that has the same perimeter as Katie's square.
  - Which shape has a greater area, Katie's square or your rectangle?



Name \_\_\_\_\_

Date \_\_\_\_\_

Use the data you gathered from Problem Sets 20 and 21 to complete the charts to show how many rectangles you can create with a given perimeter. You might not use all the spaces in the charts.

Perimeter = 10 units		
Number of rectangles you made: _____		
Width	Length	Area
1 unit	4 units	4 square units

Perimeter = 12 units		
Number of rectangles you made: _____		
Width	Length	Area

Perimeter = 14 units		
Number of rectangles you made: _____		
Width	Length	Area

Perimeter = 16 units		
Number of rectangles you made: _____		
Width	Length	Area

Perimeter = 18 units		
Number of rectangles you made: _____		
Width	Length	Area

Perimeter = 20 units		
Number of rectangles you made: _____		
Width	Length	Area

## Lesson 21

**Objective:** Construct rectangles with a given perimeter using unit squares and determine their areas.

### Suggested Lesson Structure

■ Fluency Practice	(10 minutes)
■ Application Problem	(5 minutes)
■ Concept Development	(35 minutes)
■ Student Debrief	(10 minutes)
<b>Total Time</b>	<b>(60 minutes)</b>

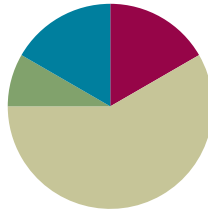

### Fluency Practice (10 minutes)

- Sprint: Multiply or Divide by 3 **3.OA.7** (10 minutes)

### Sprint: Multiply or Divide by 3 (10 minutes)

Materials: (S) Multiply or Divide by 3 Sprint

Note: This Sprint builds fluency with multiplication and division facts using units of 3.

### Application Problem (5 minutes)

Mrs. Zeck will use 14 feet of tape to mark a rectangle on the gym wall. Draw several rectangles that Mrs. Zeck could make with her tape. Label the width and length of each rectangle.

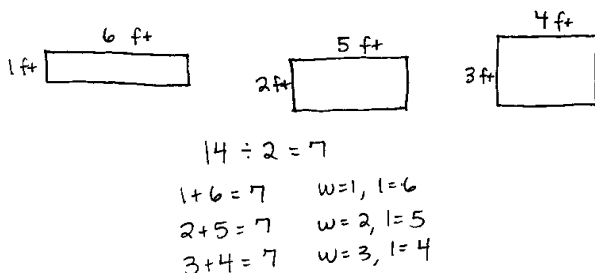

#### NOTES ON MULTIPLE MEANS OF ACTION AND EXPRESSION:

Scaffold the Application Problem for students working below grade level. One solution path (shown here) is to find half of the perimeter and list all addend pairs with a sum of 7. Set individualized goals for effort and persistence, perhaps by providing a checklist of problem-solving self-talk, such as, "What information do I know?"

Note: This problem reviews Lesson 20. If time allows, invite students to discuss which rectangular target they would want to try to hit by throwing a ball from the opposite side of the gym.

### Concept Development (35 minutes)

Materials: (S) Centimeter grid paper (Template), Problem Set, personal white board

T: Read the first sentence of Problem 1 on the Problem Set.

S: (Read: On your centimeter grid paper, shade and label as many rectangles as you can with a perimeter of 16 centimeters.)

T: Tell a partner the strategy you will use to find rectangles with a perimeter of 16 centimeters.

MP.5

S: I'll start by finding half of the perimeter, which is 8. Then, I'll write addition sentences that equal 8. The numbers in these addition sentences are the widths and lengths of the rectangles.

T: Work with a partner to find the widths and lengths for rectangles with a perimeter of 16 centimeters. (Sample student work is shown to the right.)

T: Share your work with another pair of students. If your answers are different, figure out why, and come to an agreement.

S: (Share with another pair and make adjustments.)

T: How many different rectangles did you find with a perimeter of 16 centimeters?

S: 4 rectangles!

T: Talk to a partner: Are any of your rectangles squares? How do you know?

S: Yes. The rectangle with a width of 4 and a length of 4 is a square. → That's right because all the side lengths are equal.

T: Shade each rectangle on your centimeter grid paper, and label the side lengths. Darken the perimeters of the rectangles so they stand out on the grid.

S: (Shade rectangles on the centimeter grid paper.)

$$16 \div 2 = 8$$

$$1 + 7 = 8 \quad w=1, l=7$$

$$2 + 6 = 8 \quad w=2, l=6$$

$$3 + 5 = 8 \quad w=3, l=5$$

$$4 + 4 = 8 \quad w=4, l=4$$

When students finish shading, facilitate a class discussion using the following suggested questions.

- How can you be sure that all of the rectangles have a perimeter of 16 centimeters?
- Do you think the rectangles all have the same area? Why or why not?
- Which rectangle do you think has the smallest area? The greatest area? Why?

After the discussion, ask students to finish Problem 1, which includes sketching each rectangle, labeling the side lengths, and finding the areas. Repeat the process for Problem 2 on the Problem Set, releasing students to work independently as they are ready.

### Problem Set (10 minutes)

Students should do their personal best to complete Problems 3 and 4 on the Problem Set within the allotted 10 minutes. For some classes, it may be appropriate to modify the assignment by specifying which problems they work on first. Some problems do not specify a method for solving. Students should solve these problems using the RDW approach used for Application Problems.

To prepare for Lesson 22, students should add their data from today's lesson to the sheet shown to the right. (A master copy is included at the end of this lesson.) An extra five minutes is built into the time allotted for the Concept Development to accommodate this. However, choose when the data collection might happen most smoothly for the class, perhaps at the end of the Problem Set or the Student Debrief or after completing the Exit Ticket.

Name \_\_\_\_\_ Date \_\_\_\_\_

Use the data you gathered from Problem Sets 20 and 21 to complete the charts to show how many rectangles you can create with a given perimeter. You might not use all the spaces in the charts.

Perimeter = 10 units		
Number of rectangles you made: _____		
Width	Length	Area
1 unit	4 units	4 square units

Perimeter = 12 units		
Number of rectangles you made: _____		
Width	Length	Area

Perimeter = 14 units		
Number of rectangles you made: _____		
Width	Length	Area

Perimeter = 16 units		
Number of rectangles you made: _____		
Width	Length	Area

Perimeter = 18 units		
Number of rectangles you made: _____		
Width	Length	Area

Perimeter = 20 units		
Number of rectangles you made: _____		
Width	Length	Area

### Student Debrief (10 minutes)

**Lesson Objective:** Construct rectangles with a given perimeter using unit squares and determine their areas.

The Student Debrief is intended to invite reflection and active processing of the total lesson experience.

Invite students to review their solutions for the Problem Set. They should check work by comparing answers with a partner before going over answers as a class. Look for misconceptions or misunderstandings that can be addressed in the Debrief. Guide students in a conversation to debrief the Problem Set and process the lesson.

Any combination of the questions below may be used to lead the discussion.

- Compare the rectangles you drew on your grid paper for Problems 1 and 2. What patterns do you see in the side lengths?
- Look at the charts in Problem 3. Can a rectangle with a perimeter of 10 units have a greater area than a rectangle with a perimeter of 20 units? How do you know?
- Share your answers to Problem 4. Do you know for sure what Macy's and Gavin's rectangles look like? Why or why not?

- Look at the number of rectangles you made with the given perimeters in Problems 1, 2, and 3. Why do you think you can make more rectangles with some perimeters than with others?

**Exit Ticket (3 minutes)**

After the Student Debrief, instruct students to complete the Exit Ticket. A review of their work will help with assessing students' understanding of the concepts that were presented in today's lesson and planning more effectively for future lessons. The questions may be read aloud to the students.

Name Gina Date \_\_\_\_\_

1. On your centimeter grid paper, shade and label as many rectangles as you can with a perimeter of 16 centimeters.

a. Sketch the rectangles below and label the side lengths.

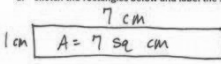
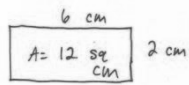
1 cm   2 cm

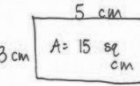
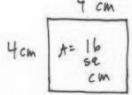
3 cm   4 cm

✓b. Find the area of each rectangle you drew above.

2. On your centimeter grid paper, shade and label as many rectangles as you can with a perimeter of 18 centimeters.

a. Sketch the rectangles below and label the side lengths.

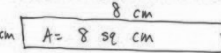
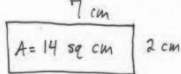
1 cm   2 cm

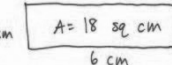
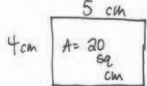
3 cm   4 cm

✓b. Find the area of each rectangle you drew above.

3. Use centimeter grid paper to shade in as many rectangles as you can with the given perimeters.

a. Use the charts below to show how many rectangles you shaded for each given perimeter. You might not use all the spaces in the charts.

Perimeter = 10 cm		
Width	Length	Area
1 cm	4 cm	4 square cm
2 cm	3 cm	6 sq cm

Perimeter = 20 cm		
Width	Length	Area
1 cm	9 cm	9 square cm
2 cm	8 cm	16 sq cm
3 cm	7 cm	21 sq cm
4 cm	6 cm	24 sq cm
5 cm	5 cm	25 sq cm

b. Did you make a square with either of the given perimeters? How do you know?

Yes, I made a square with the given perimeter of 20 cm. I know because one rectangle had side lengths all equal to 5 cm and a rectangle with 4 equal sides is a square.

4. Macy and Gavin both draw rectangles with perimeters of 16 centimeters. Use words and pictures to explain how it is possible for Macy's and Gavin's rectangles to have the same perimeters, but different areas.

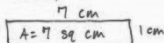
Macy:  P = 1 cm + 7 cm + 1 cm + 7 cm = 16 cm

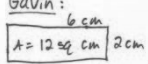
Gavin:  P = 2 cm + 6 cm + 2 cm + 6 cm = 16 cm

Macy's and Gavin's rectangles both have perimeters of 16 cm, but the areas are different because the side lengths are different and  $1 \times 7 = 7$  and  $2 \times 6 = 12$ .

## A

Number Correct: \_\_\_\_\_

Multiply or Divide by 3

1.	$2 \times 3 =$	
2.	$3 \times 3 =$	
3.	$4 \times 3 =$	
4.	$5 \times 3 =$	
5.	$1 \times 3 =$	
6.	$6 \div 3 =$	
7.	$9 \div 3 =$	
8.	$15 \div 3 =$	
9.	$3 \div 3 =$	
10.	$12 \div 3 =$	
11.	$6 \times 3 =$	
12.	$7 \times 3 =$	
13.	$8 \times 3 =$	
14.	$9 \times 3 =$	
15.	$10 \times 3 =$	
16.	$24 \div 3 =$	
17.	$21 \div 3 =$	
18.	$27 \div 3 =$	
19.	$18 \div 3 =$	
20.	$30 \div 3 =$	
21.	$\underline{\quad} \times 3 = 15$	
22.	$\underline{\quad} \times 3 = 3$	

23.	$\underline{\quad} \times 3 = 30$	
24.	$\underline{\quad} \times 3 = 6$	
25.	$\underline{\quad} \times 3 = 9$	
26.	$30 \div 3 =$	
27.	$15 \div 3 =$	
28.	$3 \div 3 =$	
29.	$6 \div 3 =$	
30.	$9 \div 3 =$	
31.	$\underline{\quad} \times 3 = 18$	
32.	$\underline{\quad} \times 3 = 21$	
33.	$\underline{\quad} \times 3 = 27$	
34.	$\underline{\quad} \times 3 = 24$	
35.	$21 \div 3 =$	
36.	$27 \div 3 =$	
37.	$18 \div 3 =$	
38.	$24 \div 3 =$	
39.	$11 \times 3 =$	
40.	$33 \div 3 =$	
41.	$12 \times 3 =$	
42.	$36 \div 3 =$	
43.	$13 \times 3 =$	
44.	$39 \div 3 =$	

## B

Number Correct: \_\_\_\_\_

Improvement: \_\_\_\_\_

Multiply or Divide by 3

1.	$1 \times 3 =$	
2.	$2 \times 3 =$	
3.	$3 \times 3 =$	
4.	$4 \times 3 =$	
5.	$5 \times 3 =$	
6.	$9 \div 3 =$	
7.	$6 \div 3 =$	
8.	$12 \div 3 =$	
9.	$3 \div 3 =$	
10.	$15 \div 3 =$	
11.	$10 \times 3 =$	
12.	$6 \times 3 =$	
13.	$7 \times 3 =$	
14.	$8 \times 3 =$	
15.	$9 \times 3 =$	
16.	$21 \div 3 =$	
17.	$18 \div 3 =$	
18.	$24 \div 3 =$	
19.	$30 \div 3 =$	
20.	$27 \div 3 =$	
21.	$\underline{\quad} \times 3 = 3$	
22.	$\underline{\quad} \times 3 = 15$	

23.	$\underline{\quad} \times 3 = 6$	
24.	$\underline{\quad} \times 3 = 30$	
25.	$\underline{\quad} \times 3 = 9$	
26.	$6 \div 3 =$	
27.	$3 \div 3 =$	
28.	$30 \div 3 =$	
29.	$15 \div 3 =$	
30.	$9 \div 3 =$	
31.	$\underline{\quad} \times 3 = 18$	
32.	$\underline{\quad} \times 3 = 24$	
33.	$\underline{\quad} \times 3 = 27$	
34.	$\underline{\quad} \times 3 = 21$	
35.	$24 \div 3 =$	
36.	$27 \div 3 =$	
37.	$18 \div 3 =$	
38.	$21 \div 3 =$	
39.	$11 \times 3 =$	
40.	$33 \div 3 =$	
41.	$12 \times 3 =$	
42.	$36 \div 3 =$	
43.	$13 \times 3 =$	
44.	$39 \div 3 =$	





3. Use centimeter grid paper to shade in as many rectangles as you can with the given perimeters.
- a. Use the charts below to show how many rectangles you shaded for each given perimeter. You might not use all the spaces in the charts.

Perimeter = 10 cm		
Number of rectangles I made: ____		
Width	Length	Area
1 cm	4 cm	4 square cm

Perimeter = 20 cm		
Number of rectangles I made: ____		
Width	Length	Area
1 cm	9 cm	9 square cm

- b. Did you make a square with either of the given perimeters? How do you know?

4. Macy and Gavin both draw rectangles with perimeters of 16 centimeters. Use words and pictures to explain how it is possible for Macy's and Gavin's rectangles to have the same perimeters but different areas.

Name \_\_\_\_\_

Date \_\_\_\_\_

On the grid below, shade and label at least two different rectangles with a perimeter of 20 centimeters.

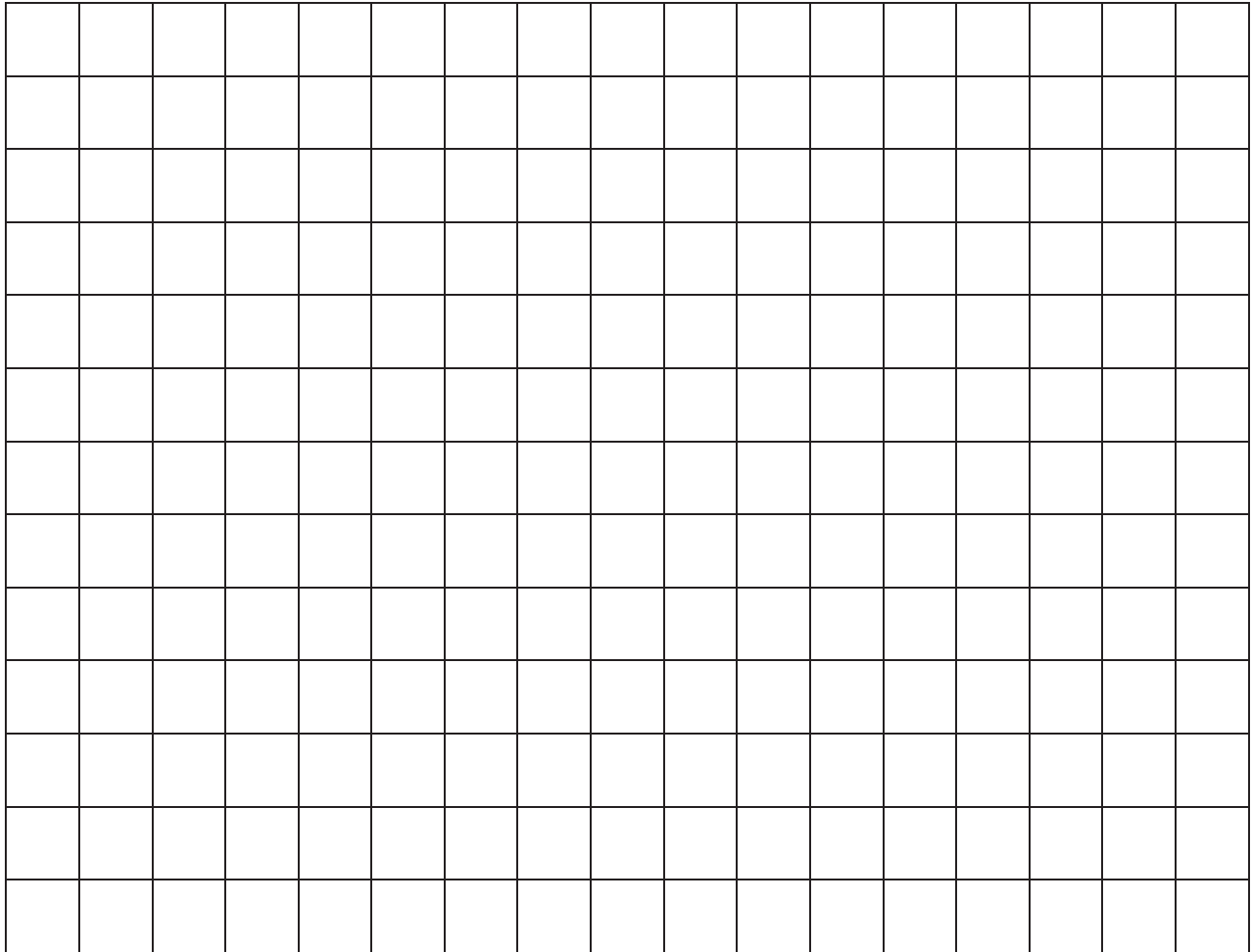

Name \_\_\_\_\_

Date \_\_\_\_\_

1. Margo finds as many rectangles as she can with a perimeter of 14 centimeters.
  - a. Shade Margo's rectangles on the grid below. Label the length and width of each rectangle.

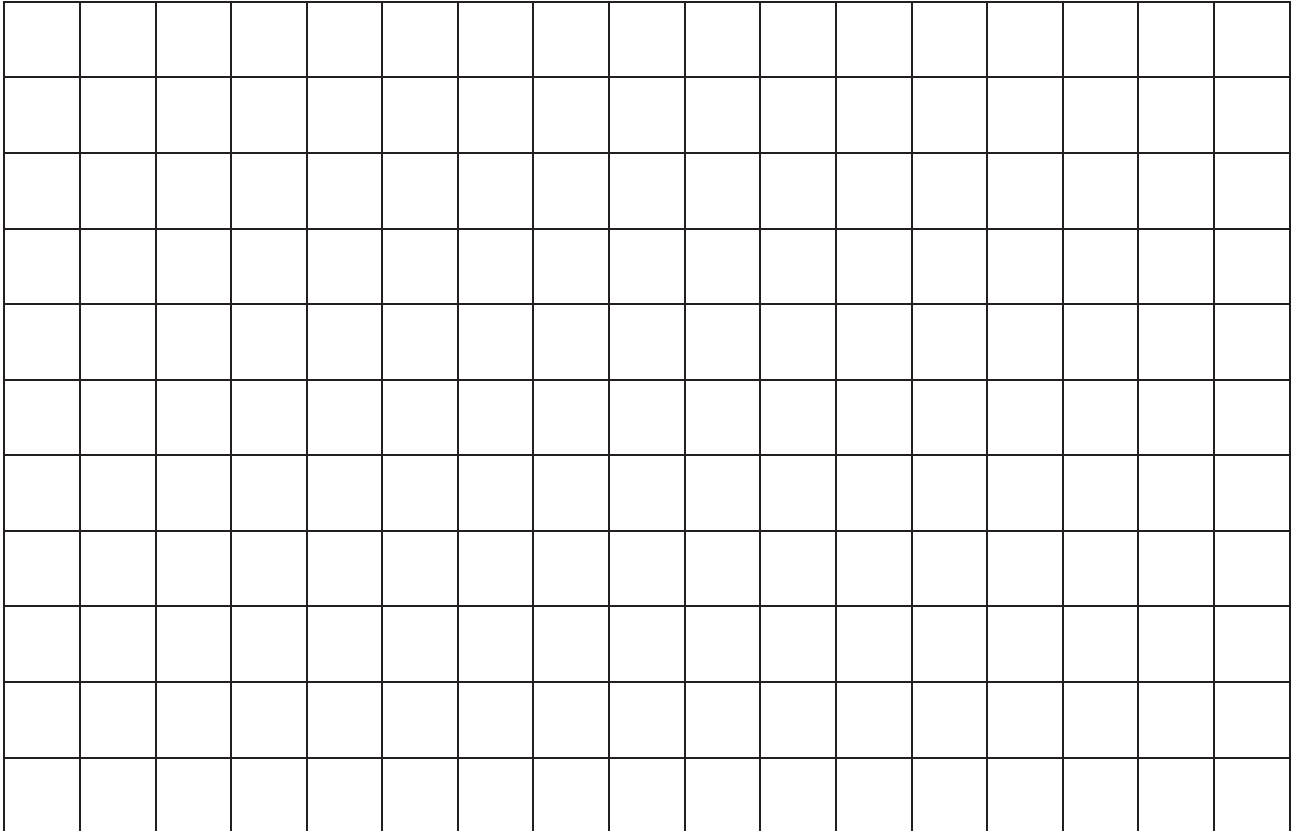

- b. Find the areas of the rectangles in part (a) above.
  - c. The perimeters of the rectangles are the same. What do you notice about the areas?

2. Tanner uses unit squares to build rectangles that have a perimeter of 18 units. He creates the chart below to record his findings.
- a. Complete Tanner's chart. You might not use all the spaces in the chart.

Perimeter = 18 units		
Number of rectangles I made: _____		
Width	Length	Area
1 unit	8 units	8 square units

- b. Explain how you found the widths and lengths in the chart above.

3. Jason and Dina both draw rectangles with perimeters of 12 centimeters, but their rectangles have different areas. Explain with words, pictures, and numbers how this is possible.

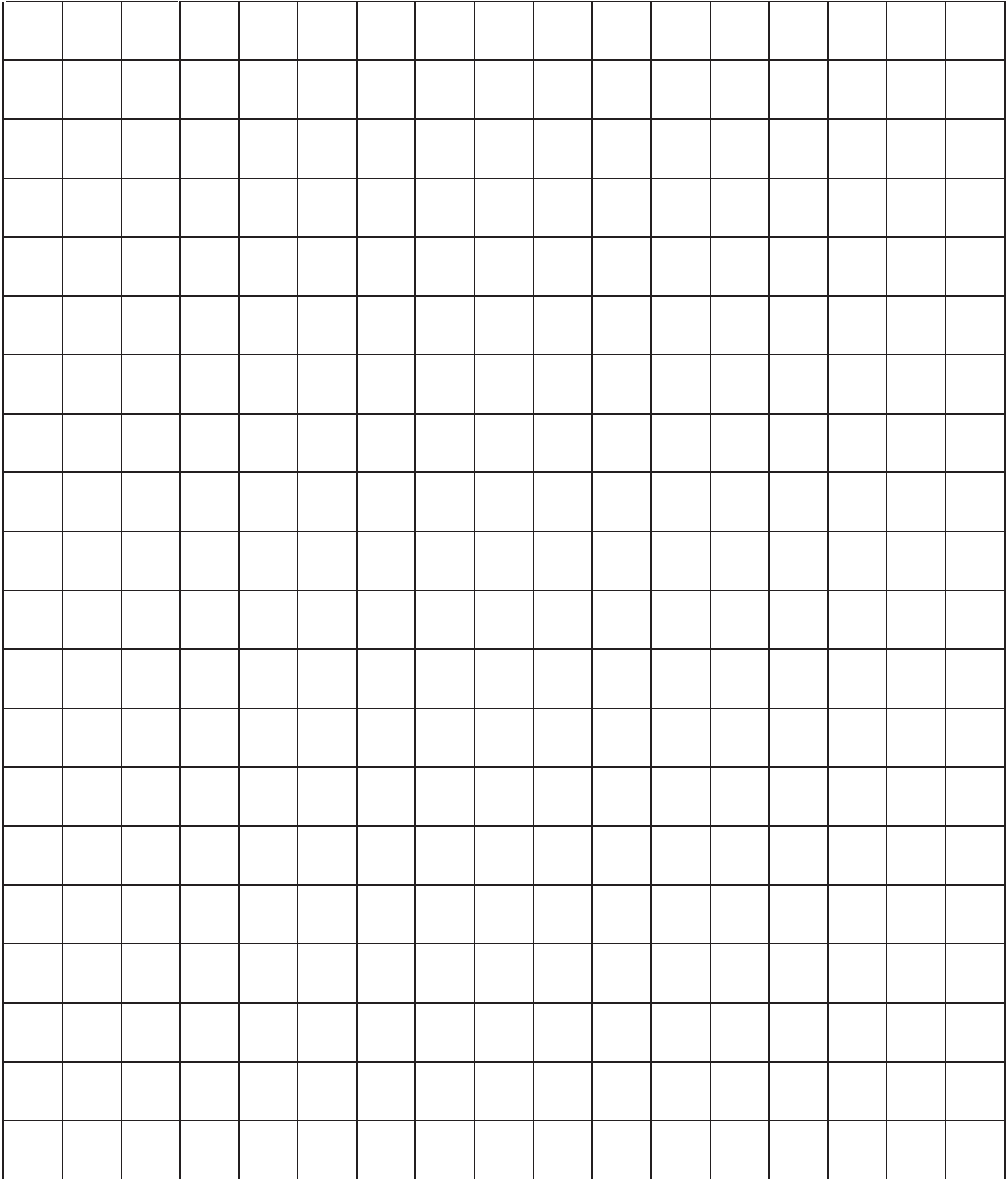

---

centimeter grid paper

Name \_\_\_\_\_

Date \_\_\_\_\_

Use the data you gathered from Problem Sets 20 and 21 to complete the charts to show how many rectangles you can create with a given perimeter. You might not use all the spaces in the charts.

Perimeter = 10 units		
Number of rectangles you made: _____		
Width	Length	Area
1 unit	4 units	4 square units

Perimeter = 12 units		
Number of rectangles you made: _____		
Width	Length	Area

Perimeter = 14 units		
Number of rectangles you made: _____		
Width	Length	Area

Perimeter = 16 units		
Number of rectangles you made: _____		
Width	Length	Area

Perimeter = 18 units		
Number of rectangles you made: _____		
Width	Length	Area

Perimeter = 20 units		
Number of rectangles you made: _____		
Width	Length	Area

## Lesson 22

**Objective:** Use a line plot to record the number of rectangles constructed in Lessons 20 and 21.

### Suggested Lesson Structure

■ Fluency Practice	(13 minutes)
■ Concept Development	(37 minutes)
■ Student Debrief	(10 minutes)
<b>Total Time</b>	<b>(60 minutes)</b>

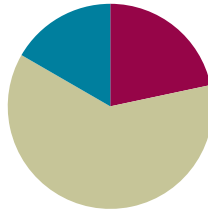

### Fluency Practice (13 minutes)

- Sprint: Multiply or Divide by 4 **3.OA.7** (10 minutes)
- Find the Perimeter and Area **3.MD.7** (3 minutes)

#### Sprint: Multiply or Divide by 4 (10 minutes)

Materials: (S) Multiply or Divide by 4 Sprint

Note: This Sprint builds fluency with multiplication and division facts using units of 4.

#### Find the Perimeter and Area (3 minutes)

Materials: (S) Personal white board

Note: This activity reviews finding perimeter and area.

- T: (Project a square with a given length of 5 cm.) This shape is a square. On your personal white board, calculate the perimeter using an addition sentence.
- S: (Write  $5\text{ cm} + 5\text{ cm} + 5\text{ cm} + 5\text{ cm} = 20\text{ cm}$ .)
- T: Calculate the area using a multiplication sentence.
- S: (Write  $5\text{ cm} \times 5\text{ cm} = 25\text{ sq cm}$ .)

Repeat this process for the remaining rectangles.



#### NOTES ON MULTIPLE MEANS OF ENGAGEMENT:

If students do not multiply and divide by 4 with fluency, review quickly or prepare students beforehand. Then, guide students to set a goal.

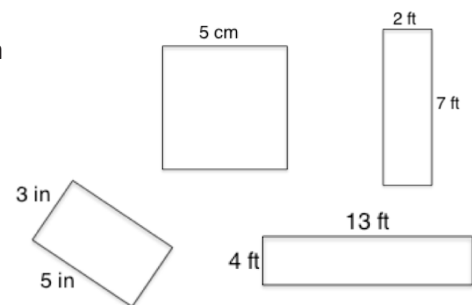

### Concept Development (37 minutes)

Materials: (T) Line plot (Template 1) (S) Problem Set, ruler, data chart from Lessons 20–21, line plot from Lesson 19, scissors, 11-inch piece of string (per pair), rectangles (Template 2) (per pair)

#### Problem 1: Draw a line plot representing measurement data.

Guide students through the process of recording the number of rectangles they made for each given perimeter on the line plot in Problem 1 of the Problem Set.

- Use a ruler to partition equal intervals.
- Label the number line to show the different perimeters.
- Record the data on the line plot using X's to represent one rectangle.

#### Problem 2: Observe and interpret data on a line plot.

T: Study the perimeter measurements on your line plot. Are they even, odd, or both?

S: They're all even!

T: Why do you think that is? Discuss with your table.

S: The teacher just made them up that way. → To get the perimeter of a rectangle, we add four sides. Maybe the totals have to be divisible by 4, so they have to be even because 4 is even? → But we don't know how to divide 10, 14, 18, or 22 by 4. → Wait. To get perimeter, we find the sum of the width and length. Then, we double it. If you double a number, I think it's always even because you have to multiply by 2. Let me try a few to check. Yep! Everything I multiply by 2 has an even product.

T: You're close! All the rectangles that we made had whole number side lengths. When we add whole number side lengths and double them, the perimeter will be even. (Pass out an 11-inch-long piece of string to each pair.) Use your ruler to measure the length of the string in inches.

S: (Measure the string.)

T: How long is the string?

S: 11 inches!

T: Work with your partner to shape your string into a rectangle.

S: (Make a rectangle with the string.)

T: What is the perimeter of your rectangle? How do you know?

S: 11 inches because it's the same as the length of the string.

T: Is 11 an odd or even number?

S: Odd!

T: So, do all rectangles have an even perimeter?

S: No!



#### NOTES ON MULTIPLE MEANS OF ACTION AND EXPRESSION:

Provide the option of wire, in addition to string, because it may be easier for students to measure and shape wire into a rectangle. However, students may need assistance cutting off an inch of wire. Gluing string or anchoring wire (so that it does not move) may decrease possible frustration as students measure side lengths. If gluing is chosen, provide additional pieces of string.



T: Use your ruler to measure the side lengths of your rectangle to the nearest quarter inch.

S: (Measure the side lengths.)

T: Are the side lengths of your rectangle whole numbers?

S: No. They have fractions of inches!

T: That's right! Your rectangle has an odd perimeter because the side lengths aren't whole numbers. Use this information to help you answer Problem 2. (Why are all of the perimeter measurements even? Do all rectangles have an even perimeter?)

S: (Answer Problem 2.)

T: Now, study the data on your line plot. Think of a true statement to share about the data. (Allow students time to think, and then invite them to share.)

S: We made the most rectangles with a perimeter of 20 units. → We made the fewest rectangles with a perimeter of 10 units. → We made the same number of rectangles with perimeters of 12 and 14 units and 16 and 18 units. → We made a total of 21 rectangles from these six perimeters. → The number of rectangles is mostly growing as the perimeter measurement gets larger.

T: Let me show you what the line plot looks like with more measurements. (Project Template 1, shown to the right.) What pattern do you notice in the data?

Template 1

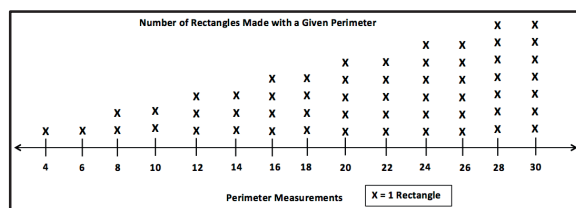

S: Starting with 8, the number of rectangles grows for every other measurement. → Not just that, but they grow in pairs. Look. 4 and 6 are the same. Then, 8 and 10 are the same, except they grow by 1 more possible rectangle. It's like that all the way to 30!

T: Using this pattern, how many rectangles do you think you could build with unit squares, given perimeters of 32 units and 34 units?

S: Both would be 8 rectangles since each pair of measurements grows by 1.

T: Use your ruler to help you cut an inch off your string. (Allow students time to cut.) How long is your string now?

S: 10 inches.

T: (Pass out Template 2, shown to the right.) Working with your partner, use your string to measure the perimeters of these rectangles. (Allow students time to measure.) What did you notice about the perimeters of these rectangles?

Template 2

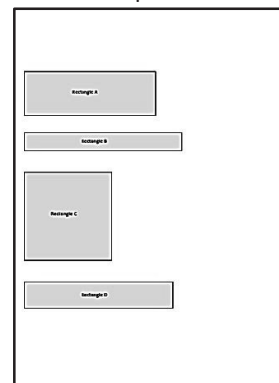

MP.6

S: They're all 10 inches!

T: Use your ruler to measure the side lengths of Rectangle A to the nearest quarter inch. (Allow students time to measure.) Are the side lengths of this rectangle whole numbers?

S: No. They have fractions of inches.

T: On your line plot, it shows that you only made two rectangles with a perimeter of 10, but here we have four rectangles with a perimeter of 10. When we have side lengths that are not whole numbers, we can find more rectangles for given perimeters than our line plot shows.

**Problem 3: Compare area and perimeter line plots.**

- T: Let's compare today's line plot with the one you created in Lesson 19. (Allow students time to take out their Lesson 19 Problem Set.) How are the line plots different?
- S: One line plot shows the number of rectangles for a given area. The other shows the number of rectangles for a given perimeter.
- T: Look at the data on both line plots for 12. What do you notice?
- S: There is an equal number of rectangles that we made for that perimeter and that area.
- T: Is that true for other numbers on your line plots?
- S: No!
- T: Do you think there's a connection between the number of rectangles you built for a given area and perimeter?
- S: Sometimes, but not always. → It only looks like there is a relationship with certain numbers, like 12. → There's not really a pattern, so I don't think there's a relationship.
- T: Right. Using our data, we can't make a general rule about a connection between perimeter and area. Take some time to record your thoughts in Problem 3. (Compare the two line plots we created. Is there any reason to think that knowing only the area of a rectangle would help you to figure out its perimeter or knowing only the perimeter of a rectangle would help you figure out its area?)
- S: (Record.)

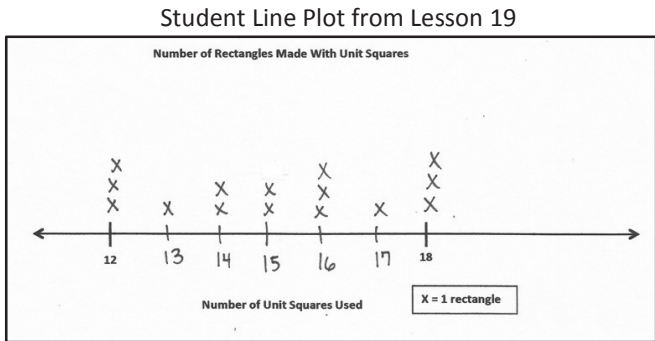
**Problem Set (10 minutes)**

Students should do their personal best to complete Problems 4 and 5 within the allotted 10 minutes. For some classes, it may be appropriate to modify the assignment by specifying which problems they work on first. Some problems do not specify a method for solving. Students should solve these problems using the RDW approach used for Application Problems.

**Student Debrief (10 minutes)**

**Lesson Objective:** Use a line plot to record the number of rectangles constructed in Lessons 20 and 21.

The Student Debrief is intended to invite reflection and active processing of the total lesson experience. Invite students to review their solutions for the Problem Set.

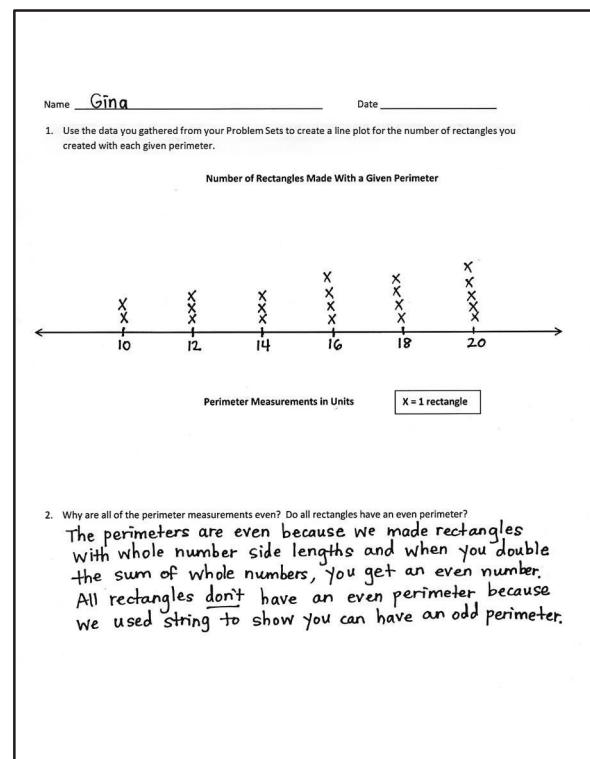

They should check work by comparing answers with a partner before going over answers as a class. Look for misconceptions or misunderstandings that can be addressed in the Debrief. Guide students in a conversation to debrief the Problem Set and process the lesson.

Any combination of the questions below may be used to lead the discussion.

- How did using a ruler help you partition your number line evenly?
- How does a line plot make data easier to read and compare?
- Share your answers to Problem 4.
- Did you agree with Alicia in Problem 5? Why or why not?
- What did using the string in today's lesson help you discover about perimeter?
- What do you notice about the connection between area and perimeter?

### Exit Ticket (3 minutes)

After the Student Debrief, instruct students to complete the Exit Ticket. A review of their work will help with assessing students' understanding of the concepts that were presented in today's lesson and planning more effectively for future lessons. The questions may be read aloud to the students.

3. Compare the two line plots we created. Is there any reason to think that knowing only the area of a rectangle would help you to figure out its perimeter or knowing only the perimeter of a rectangle would help you figure out its area?

No, there is no connection between area and perimeter. Knowing one does not help you find the other.

4. Sumi uses unit square tiles to build 3 rectangles that have an area of 32 square units. Does knowing this help her find the number of rectangles she can build for a perimeter of 32 units? Why or why not?

No, knowing the number of rectangles she built with an area of 32 sq units does not help her find the number of rectangles she can build for a perimeter of 32 units. If you halve 32 units to get 16 units, there will be more than 3 pairs of numbers that add to 16.

5. George draws 3 rectangles that have a perimeter of 14 centimeters. Alicia tells George that there are more than 3 rectangles that have a perimeter of 14 centimeters. Explain why Alicia is correct.

Alicia is correct, because George probably only drew rectangles with whole number side lengths. He could draw more rectangles if he used fractions.

## A

Number Correct: \_\_\_\_\_

Multiply or Divide by 4

1.	$2 \times 4 =$	
2.	$3 \times 4 =$	
3.	$4 \times 4 =$	
4.	$5 \times 4 =$	
5.	$1 \times 4 =$	
6.	$8 \div 4 =$	
7.	$12 \div 4 =$	
8.	$20 \div 4 =$	
9.	$4 \div 4 =$	
10.	$16 \div 4 =$	
11.	$6 \times 4 =$	
12.	$7 \times 4 =$	
13.	$8 \times 4 =$	
14.	$9 \times 4 =$	
15.	$10 \times 4 =$	
16.	$32 \div 4 =$	
17.	$28 \div 4 =$	
18.	$36 \div 4 =$	
19.	$24 \div 4 =$	
20.	$40 \div 4 =$	
21.	$\underline{\quad} \times 4 = 20$	
22.	$\underline{\quad} \times 4 = 4$	

23.	$\underline{\quad} \times 4 = 40$	
24.	$\underline{\quad} \times 4 = 8$	
25.	$\underline{\quad} \times 4 = 12$	
26.	$40 \div 4 =$	
27.	$20 \div 4 =$	
28.	$4 \div 4 =$	
29.	$8 \div 4 =$	
30.	$12 \div 4 =$	
31.	$\underline{\quad} \times 4 = 24$	
32.	$\underline{\quad} \times 4 = 28$	
33.	$\underline{\quad} \times 4 = 36$	
34.	$\underline{\quad} \times 4 = 32$	
35.	$28 \div 4 =$	
36.	$36 \div 4 =$	
37.	$24 \div 4 =$	
38.	$32 \div 4 =$	
39.	$11 \times 4 =$	
40.	$44 \div 4 =$	
41.	$12 \div 4 =$	
42.	$48 \div 4 =$	
43.	$14 \times 4 =$	
44.	$56 \div 4 =$	

## B

Number Correct: \_\_\_\_\_

Improvement: \_\_\_\_\_

Multiply or Divide by 4

1.	$1 \times 4 =$	
2.	$2 \times 4 =$	
3.	$3 \times 4 =$	
4.	$4 \times 4 =$	
5.	$5 \times 4 =$	
6.	$12 \div 4 =$	
7.	$8 \div 4 =$	
8.	$16 \div 4 =$	
9.	$4 \div 4 =$	
10.	$20 \div 4 =$	
11.	$10 \times 4 =$	
12.	$6 \times 4 =$	
13.	$7 \times 4 =$	
14.	$8 \times 4 =$	
15.	$9 \times 4 =$	
16.	$28 \div 4 =$	
17.	$24 \div 4 =$	
18.	$32 \div 4 =$	
19.	$40 \div 4 =$	
20.	$36 \div 4 =$	
21.	$\underline{\quad} \times 4 = 4$	
22.	$\underline{\quad} \times 4 = 20$	

23.	$\underline{\quad} \times 4 = 8$	
24.	$\underline{\quad} \times 4 = 40$	
25.	$\underline{\quad} \times 4 = 12$	
26.	$8 \div 4 =$	
27.	$4 \div 4 =$	
28.	$40 \div 4 =$	
29.	$20 \div 4 =$	
30.	$12 \div 4 =$	
31.	$\underline{\quad} \times 4 = 12$	
32.	$\underline{\quad} \times 4 = 16$	
33.	$\underline{\quad} \times 4 = 36$	
34.	$\underline{\quad} \times 4 = 28$	
35.	$32 \div 4 =$	
36.	$36 \div 4 =$	
37.	$24 \div 4 =$	
38.	$28 \div 4 =$	
39.	$11 \times 4 =$	
40.	$44 \div 4 =$	
41.	$12 \times 4 =$	
42.	$48 \div 4 =$	
43.	$13 \times 4 =$	
44.	$52 \div 4 =$	

Name \_\_\_\_\_

Date \_\_\_\_\_

1. Use the data you gathered from your Problem Sets to create a line plot for the number of rectangles you created with each given perimeter.

**Number of Rectangles Made with a Given Perimeter**

Perimeter Measurements in Units

X = 1 Rectangle
-----------------

2. Why are all of the perimeter measurements even? Do all rectangles have an even perimeter?



Name \_\_\_\_\_

Date \_\_\_\_\_

Suppose you have a rectangle with a perimeter of 2 cm. What can you conclude about the side lengths? Can all 4 sides of the rectangle measure a whole number of centimeters?



Name \_\_\_\_\_

Date \_\_\_\_\_

1. The following line plot shows the number of rectangles a student made using square unit tiles. Use the line plot to answer the questions below.

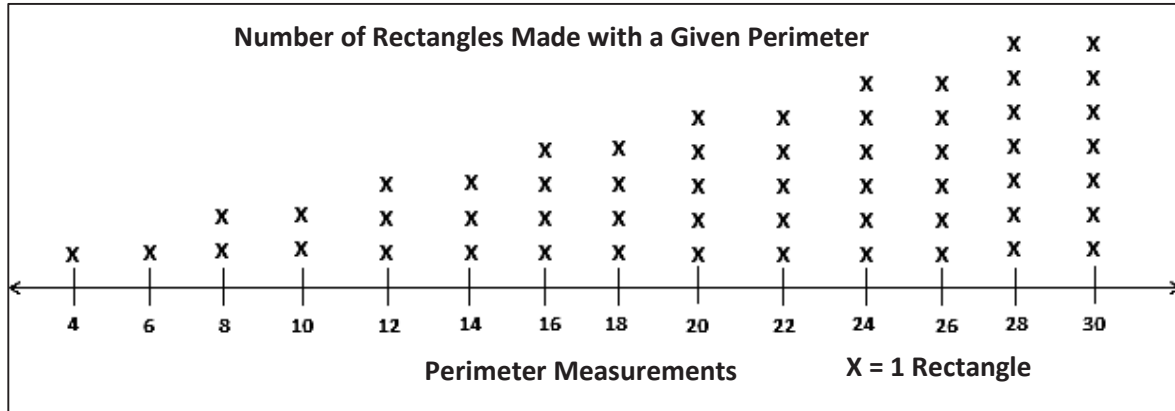

- a. Why are all of the perimeter measurements even? Do all rectangles have even perimeters?
- b. Explain the pattern in the line plot. What types of side lengths make this pattern possible?
- c. How many X's would you draw for a perimeter of 32? Explain how you know.

2. Luis uses square inch tiles to build a rectangle with a perimeter of 24 inches. Does knowing this help him find the number of rectangles he can build with an area of 24 square inches? Why or why not?
3. Esperanza makes a rectangle with a piece of string. She says the perimeter of her rectangle is 33 centimeters. Explain how it's possible for her rectangle to have an odd perimeter.

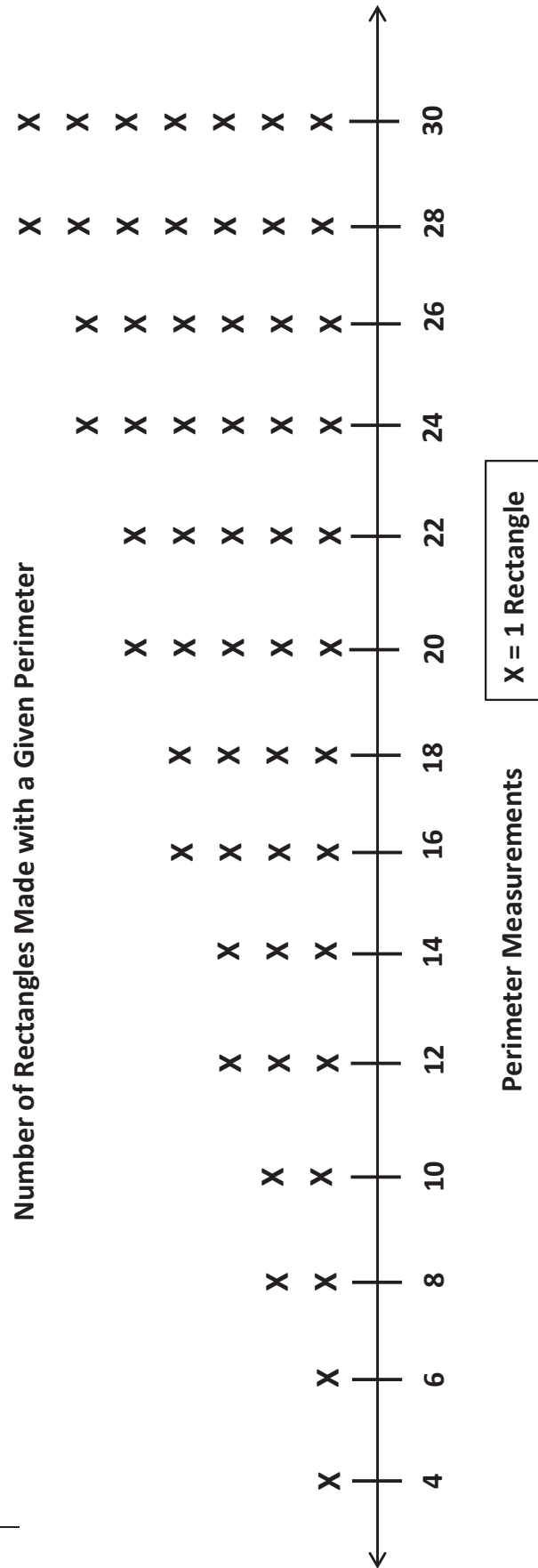

line plot

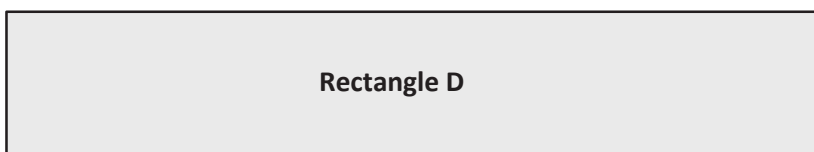
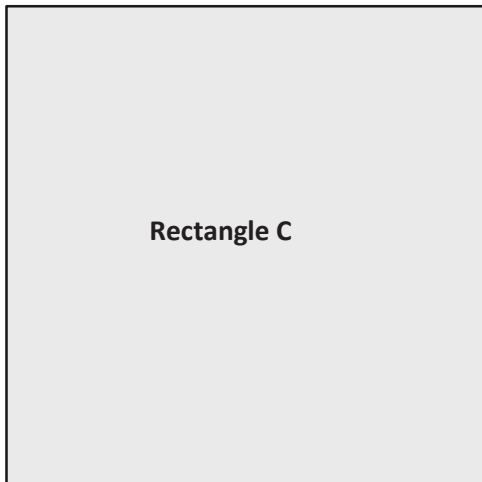
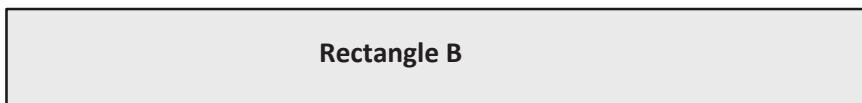
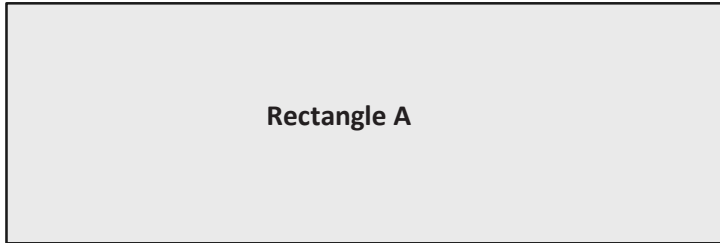

---

rectangles



## Topic E

# Problem Solving with Perimeter and Area

## 3.MD.8, 3.G.1

<b>Focus Standards:</b>	3.MD.8	Solve real world and mathematical problems involving perimeters of polygons, including finding the perimeter given the side lengths, finding an unknown side length, and exhibiting rectangles with the same perimeter and different areas or with the same area and different perimeters.
	3.G.1	Understand that shapes in different categories (e.g., rhombuses, rectangles, and others) may share attributes (e.g., having four sides), and that the shared attributes can define a larger category (e.g., quadrilaterals). Recognize rhombuses, rectangles, and squares as examples of quadrilaterals, and draw examples of quadrilaterals that do not belong to any of these subcategories.
<b>Instructional Days:</b>	8	
<b>Coherence -Links from:</b>	G2–M6	Foundations of Multiplication and Division
	G3–M3	Multiplication and Division with Units of 0, 1, 6–9, and Multiples of 10
	G3–M4	Multiplication and Area
	<b>-Links to:</b>	G4–M3

In Topic E, students solve problems with perimeter and area. Lesson 23 focuses on solving a variety of word problems involving perimeter. This provides students an opportunity to use multiplication and division strategies to solve problems about perimeter.

Students use rectangles and circles to create robots and environments for the robots using specified perimeter measurements in Lessons 24 through 27. They reason about the different whole number side lengths that may be produced for a given perimeter. For example, when given the requirement that the perimeter of the arms of the robot must be 14 inches, students experiment and draw different possibilities for rectangles to determine which ones they prefer for the robot's arms. Students cut out and assemble the parts of the robot from grid or construction paper and compare their robots with those of their peers. This comparison leads to a discussion about the different areas that are generated for their classmates' robot bodies, despite the fact that they have the same given perimeter. The final lesson in this sequence provides an opportunity for peer review and critique.

Students return to problem solving in Lessons 28 and 29, this time working with a variety of word problems involving both area and perimeter. For example, if students are given both the length and the width of a rectangular football field, they should be able to determine both the perimeter and the area of the field. In these lessons, students explore and develop strategies for solving a sequence of increasingly complex problems. In Lesson 30, students further develop analyzing and critiquing skills. They initially discuss anonymous student work samples before sharing their own work and receiving feedback in small groups.

### A Teaching Sequence Toward Mastery of Problem Solving with Perimeter and Area

**Objective 1: Solve a variety of word problems with perimeter.**  
(Lesson 23)

**Objective 2: Use rectangles to draw a robot with specified perimeter measurements, and reason about the different areas that may be produced.**  
(Lessons 24–27)

**Objective 3: Solve a variety of word problems involving area and perimeter using all four operations.**  
(Lessons 28–29)

**Objective 4: Share and critique peer strategies for problem solving.**  
(Lesson 30)

## Lesson 23

Objective: Solve a variety of word problems with perimeter.

### Suggested Lesson Structure

■ Fluency Practice	(10 minutes)
■ Concept Development	(40 minutes)
■ Student Debrief	(10 minutes)
<b>Total Time</b>	<b>(60 minutes)</b>

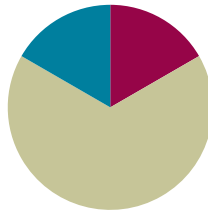

### Fluency Practice (10 minutes)

- Sprint: Multiply or Divide by 5 **3.OA.7** (10 minutes)

### Sprint: Multiply or Divide by 5 (10 minutes)

Materials: (S) Multiply or Divide by 5 Sprint

Note: This Sprint builds fluency with multiplication and division facts using units of 5.

### Concept Development (40 minutes)

Materials: (S) Problem Set

**MP.1**

In this problem-solving lesson, students work in pairs or independently to solve the six problems on the Problem Set. The teacher facilitates conversation and may provide structure for problem solving using Steps 1–3 (on the next page). Specific information about each problem follows and can be used to facilitate conversation.

### Suggested Problem-Solving Steps

For each problem, select two pairs of students to work at the class board or central space. Other students work independently or in pairs at their tables.



#### NOTES ON MULTIPLE MEANS OF ENGAGEMENT:

Give everyone a fair chance to be successful by providing appropriate scaffolds. Demonstrating students may use peer translators or sentence frames to present and respond to feedback. Models shared may include concrete manipulatives or adaptive materials.

If the pace of the lesson is a consideration, prepare presenters beforehand. Problem 4 may be most approachable for students working below grade level.

**1. Read and model.**

Review the following questions after reading the first problem:

- Can you draw something?
- What can you draw?
- What conclusions can you make from your drawing?

When most students have finished, have the pairs of students at the board share only their labeled diagrams. Have the demonstrating students receive and respond to feedback and questions from their peers.

**NOTE ON  
MULTIPLE MEANS  
OF REPRESENTATION:**

Students who have difficulty drawing an octagon to solve Problem 1 might choose instead to model with a tape diagram consisting of 8 equal parts and having a total value of 48 cm.

**2. Write an equation, calculate to solve, and write a statement.**

Allow time for students to finish work on the question. They then retrace the steps of their thinking as they share their work with a partner or another pair. Students write their equations and statements on their own Problem Sets. Demonstrating students can model this process for others.

**3. Assess the solution for reasonableness.**

Give students one to two minutes to validate and explain the reasonableness of their solutions. Two or three of the following sentence starters may be provided to guide them in this work:

- I reread the question to remind myself that it asks for \_\_\_\_\_.
- My answer matches what the question asks because \_\_\_\_\_.
- The units of my answer make sense because \_\_\_\_\_.
- I know my answer is neither too small nor too big because \_\_\_\_\_.
- My answer would not make any sense if it was \_\_\_\_\_ because \_\_\_\_\_.

**Problem 1: Gale makes a miniature stop sign, a regular octagon, with a perimeter of 48 centimeters for the town he built with blocks. What is the length of each side of the stop sign?**

Students might solve by first drawing an octagon, then labeling a side length with a letter, and dividing the perimeter (48 cm) by the number of sides on an octagon (8).

**Problem 2: Travis bends wire to make rectangles. Each rectangle measures 34 inches by 12 inches. What is the total length of the wire needed for two rectangles?**

This is a two-step problem. Students find the perimeter of one rectangle and then add to find the perimeter of two rectangles. They should recognize that the total perimeter of two rectangles is equal to the total length of wire needed. To solve the first step, students might draw a rectangle, label the side lengths, and find the perimeter. In the second step, students might use a variety of strategies to solve  $92 + 92$ , including using the standard algorithm or adding like units: 9 tens plus 9 tens equals 18 tens, and 2 ones plus 2 ones equals 4 ones, and 18 tens 4 ones equals 184.



**Problem 3: The perimeter of a rectangular bathroom is 32 feet. The width of the room is 8 feet. What is the length of the room?**

This problem presents a new complexity because it is the first time students find an unknown side length given the perimeter and one side length. This is a two-step word problem, which can be approached in a variety of ways. Knowing that opposite sides of a rectangle are equal, students might first divide the perimeter by 2 ( $32 \text{ ft} \div 2 = 16 \text{ ft}$ ) and then find the number pair that adds to 16 ( $8 \text{ ft} + \underline{\quad} \text{ ft} = 16 \text{ ft}$ ). In their problem-solving process, students might include a drawing of the rectangular room and label the unknown length with a letter.

Students may be tempted to divide the given perimeter (32 feet) by the width of the room (8 feet) since this is a fact they know. However, they should see that a 4-foot by 8-foot rectangle does not have a perimeter of 32 feet.

**Problem 4: Raj uses 6-inch square tiles to make a rectangle, as shown below [to the right]. What is the perimeter of the rectangle in inches?**

Students are not given the length or width of the rectangle but should recognize that its square tiles each have side lengths of 6 inches. This problem allows for a variety of strategies to find perimeter. Some students might first find the value of each side length, either by adding or multiplying sixes. Then, they could add or double each side length to find the perimeter. Others might realize that the perimeter is equal to 16 sixes and apply the break apart and distribute strategy to find the total. Encourage diversity with solution strategies to make for interesting conversation about the problem.

Some students might mistakenly believe that they can count the unit squares that make up the perimeter (12 unit squares) and multiply that number by 6, getting an answer of 72 inches. If students count unit squares, they need to be sure to count the sides of the unit squares that make up the perimeter.

Name Gina Date \_\_\_\_\_

1. Gale makes a miniature stop sign, a regular octagon, with a perimeter of 48 centimeters for the town he built with blocks. What is the length of each side of the stop sign?

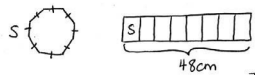

$$S = 48 \text{ cm} \div 8$$

$$S = 6 \text{ cm}$$

The length of each side is 6 cm.

2. Travis bends wire to make rectangles. Each rectangle measures 34 inches by 12 inches. What is the total length of the wire needed for two rectangles?

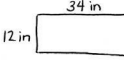
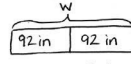
$$P = 34 \text{ in} + 34 \text{ in} + 12 \text{ in} + 12 \text{ in}$$

$$P = 92 \text{ in}$$

$$W = 92 \text{ in} + 92 \text{ in}$$

$$= 184 \text{ in}$$

The total length of the wire is 184 inches.

3. The perimeter of a rectangular bathroom is 32 feet. The width of the room is 8 feet. What is the length of the room?



$$32 \text{ ft} \div 2 = 16 \text{ ft}$$

$$8 \text{ ft} + l = 16 \text{ ft}$$

$$l = 8 \text{ ft}$$

The length of the room is 8 feet.  
It's a square!

4. Raj uses 6-inch square tiles to make a rectangle, as shown below. What is the perimeter of the rectangle in inches?

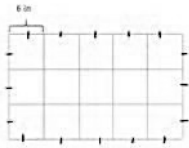

$$P = 16 \text{ sixes}$$

$$P = 10 \text{ sixes} + 6 \text{ sixes}$$

$$P = 60 + 36$$

$$P = 96$$

The perimeter of the rectangle is 96 inches.

5. Misha makes a 4-foot by 6-foot rectangular banner. She puts ribbon around the outside edges. The ribbon costs \$2 per foot. What is the total cost of the ribbon?



$$C = 20 \times 2$$

$$= 40$$

The total cost of the ribbon is \$40.

6. Colton buys a roll of wire fencing that is 120 yards long. He uses it to fence in his 18-yard by 24-yard rectangular garden. Will Colton have enough wire fencing left over to fence in a 6-yard by 8-yard rectangular play space for his pet rabbit?

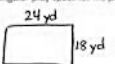
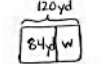
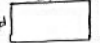
$$P = 24 \text{ yd} + 18 \text{ yd} + 24 \text{ yd} + 18 \text{ yd}$$

$$P = 42 \text{ yd} + 42 \text{ yd}$$

$$P = 84 \text{ yd}$$

$$W = 120 \text{ yd} - 84 \text{ yd}$$

$$W = 36 \text{ ydc}$$

$$P = (2 \times 8 \text{ yd}) + (2 \times 6 \text{ yd})$$

$$= 16 \text{ yd} + 12 \text{ yd}$$

$$P = 28 \text{ yd}$$

Yes, he will have enough wire because he has 36 yards but he only needs 28 yards.

**Problem 5: Mischa makes a 4-foot by 6-foot rectangular banner. She puts ribbon around the outside edges. The ribbon costs \$2 per foot. What is the total cost of the ribbon?**

Students recognize that the length of the ribbon is equal to the perimeter of the banner, so they find the perimeter of the banner (20 feet). They might calculate the cost of the ribbon by multiplying its length (20 feet) by the cost (\$2 per foot). Students can use a variety of strategies to solve, including turning it into a doubles addition fact or thinking of it as 2 tens times 2. Students might also calculate the cost of the ribbon for each side and then add to find the total cost. Encourage drawing the rectangular banner with the side lengths labeled. In the second step, encourage using a letter to represent the unknown cost of the ribbon.

**Problem 6: Colton buys a roll of wire fencing that is 120 yards long. He uses it to fence in his 18-yard by 24-yard rectangular garden. Will Colton have enough wire fencing left over to fence in a 6-yard by 8-yard rectangular play space for his pet rabbit?**

To solve, students need to find the perimeter of the garden, the difference between the length of the wire fencing and the perimeter of the garden, and the perimeter of the rabbit's play space. Students then compare the amount of leftover fencing to the perimeter of the rabbit's play space to determine whether or not Colton has enough left over.

### Student Debrief (10 minutes)

**Lesson Objective:** Solve a variety of word problems with perimeter.

The Student Debrief is intended to invite reflection and active processing of the total lesson experience.

Invite students to review their solutions for the Problem Set. They should check work by comparing answers with a partner before going over answers as a class. Look for misconceptions or misunderstandings that can be addressed in the Debrief. Guide students in a conversation to debrief the Problem Set and process the lesson.

Any combination of the questions below may be used to lead the discussion.

- How was setting up the problem to solve Problem 1 different from setting up the other problems? What did you need to know about the stop sign before you could solve?
- Explain to a partner how knowing the perimeter and the width helped you find the length of the rectangle in Problem 3.
- Explain to a partner how you were able to find the perimeter of the rectangle in Problem 4 without knowing either side length.
- How does knowing the perimeter of the banner in Problem 5 help you find the cost of the ribbon?
- You found that Colton has enough fencing to complete both projects in Problem 6. How much fencing will be left over after he fences in his garden and a play space for his rabbit?
- Which problem did you find most difficult? Why?

### Exit Ticket (3 minutes)

After the Student Debrief, instruct students to complete the Exit Ticket. A review of their work will help with assessing students' understanding of the concepts that were presented in today's lesson and planning more effectively for future lessons. The questions may be read aloud to the students.

A

Number Correct: \_\_\_\_\_

Multiply or Divide by 5

1.	$2 \times 5 =$	
2.	$3 \times 5 =$	
3.	$4 \times 5 =$	
4.	$5 \times 5 =$	
5.	$1 \times 5 =$	
6.	$10 \div 5 =$	
7.	$15 \div 5 =$	
8.	$25 \div 5 =$	
9.	$5 \div 5 =$	
10.	$20 \div 5 =$	
11.	$6 \times 5 =$	
12.	$7 \times 5 =$	
13.	$8 \times 5 =$	
14.	$9 \times 5 =$	
15.	$10 \times 5 =$	
16.	$40 \div 5 =$	
17.	$35 \div 5 =$	
18.	$45 \div 5 =$	
19.	$30 \div 5 =$	
20.	$50 \div 5 =$	
21.	$\underline{\quad} \times 5 = 25$	
22.	$\underline{\quad} \times 5 = 5$	

23.	$\underline{\quad} \times 5 = 50$	
24.	$\underline{\quad} \times 5 = 10$	
25.	$\underline{\quad} \times 5 = 15$	
26.	$50 \div 5 =$	
27.	$25 \div 5 =$	
28.	$5 \div 5 =$	
29.	$10 \div 5 =$	
30.	$15 \div 5 =$	
31.	$\underline{\quad} \times 5 = 30$	
32.	$\underline{\quad} \times 5 = 35$	
33.	$\underline{\quad} \times 5 = 45$	
34.	$\underline{\quad} \times 5 = 40$	
35.	$35 \div 5 =$	
36.	$45 \div 5 =$	
37.	$30 \div 5 =$	
38.	$40 \div 5 =$	
39.	$11 \times 5 =$	
40.	$55 \div 5 =$	
41.	$15 \div 5 =$	
42.	$60 \div 5 =$	
43.	$12 \times 5 =$	
44.	$70 \div 5 =$	

## B

Number Correct: \_\_\_\_\_

Improvement: \_\_\_\_\_

Multiply or Divide by 5

1.	$1 \times 5 =$	
2.	$2 \times 5 =$	
3.	$3 \times 5 =$	
4.	$4 \times 5 =$	
5.	$5 \times 5 =$	
6.	$15 \div 5 =$	
7.	$10 \div 5 =$	
8.	$20 \div 5 =$	
9.	$5 \div 5 =$	
10.	$25 \div 5 =$	
11.	$10 \times 5 =$	
12.	$6 \times 5 =$	
13.	$7 \times 5 =$	
14.	$8 \times 5 =$	
15.	$9 \times 5 =$	
16.	$35 \div 5 =$	
17.	$30 \div 5 =$	
18.	$40 \div 5 =$	
19.	$50 \div 5 =$	
20.	$45 \div 5 =$	
21.	$\underline{\quad} \times 5 = 5$	
22.	$\underline{\quad} \times 5 = 25$	

23.	$\underline{\quad} \times 5 = 10$	
24.	$\underline{\quad} \times 5 = 50$	
25.	$\underline{\quad} \times 5 = 15$	
26.	$10 \div 5 =$	
27.	$5 \div 5 =$	
28.	$50 \div 5 =$	
29.	$25 \div 5 =$	
30.	$15 \div 5 =$	
31.	$\underline{\quad} \times 5 = 15$	
32.	$\underline{\quad} \times 5 = 20$	
33.	$\underline{\quad} \times 5 = 45$	
34.	$\underline{\quad} \times 5 = 35$	
35.	$40 \div 5 =$	
36.	$45 \div 5 =$	
37.	$30 \div 5 =$	
38.	$35 \div 5 =$	
39.	$11 \times 5 =$	
40.	$55 \div 5 =$	
41.	$12 \times 5 =$	
42.	$60 \div 5 =$	
43.	$13 \times 5 =$	
44.	$65 \div 5 =$	



4. Raj uses 6-inch square tiles to make a rectangle, as shown below. What is the perimeter of the rectangle in inches?

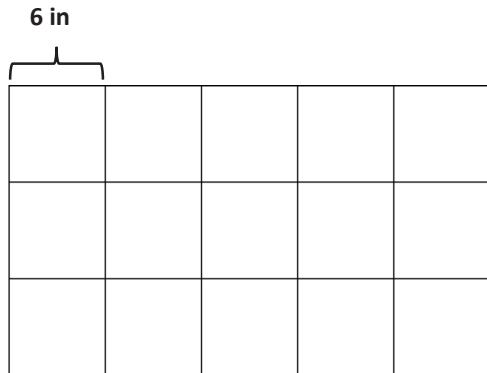

5. Mischa makes a 4-foot by 6-foot rectangular banner. She puts ribbon around the outside edges. The ribbon costs \$2 per foot. What is the total cost of the ribbon?
6. Colton buys a roll of wire fencing that is 120 yards long. He uses it to fence in his 18-yard by 24-yard rectangular garden. Will Colton have enough wire fencing left over to fence in a 6-yard by 8-yard rectangular play space for his pet rabbit?

Name \_\_\_\_\_

Date \_\_\_\_\_

Adriana traces a regular triangle to create the shape below. The perimeter of her shape is 72 centimeters. What are the side lengths of the triangle?

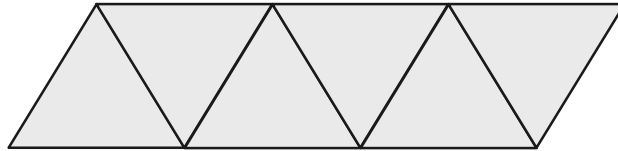





4. Manny draws 3 regular pentagons to create the shape shown below. The perimeter of 1 of the pentagons is 45 inches. What is the perimeter of Manny's new shape?

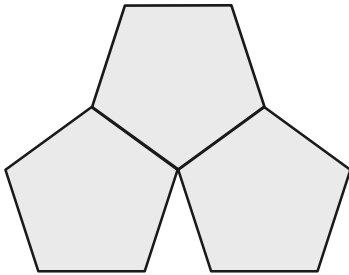

5. Johnny uses 2-inch square tiles to make a square, as shown below. What is the perimeter of Johnny's square?

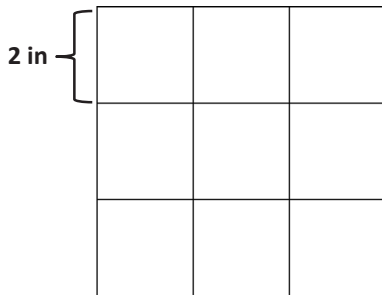

6. Lisa tapes three 7-inch by 9-inch pieces of construction paper together to make a happy birthday sign for her mom. She uses a piece of ribbon that is 144 inches long to make a border around the outside edges of the sign. How much ribbon is leftover?

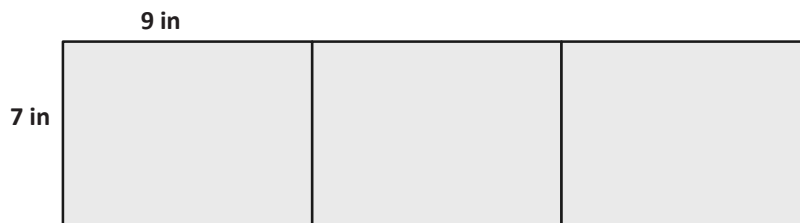

## Lesson 24

**Objective:** Use rectangles to draw a robot with specified perimeter measurements, and reason about the different areas that may be produced.

### Suggested Lesson Structure

■ Fluency Practice	(12 minutes)
■ Concept Development	(38 minutes)
■ Student Debrief	(10 minutes)
<b>Total Time</b>	<b>(60 minutes)</b>

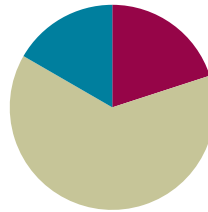

### Fluency Practice (12 minutes)

- Multiply by 6 **3.OA.7** (8 minutes)
- Find the Side Lengths **3.MD.8** (4 minutes)

### Multiply by 6 (8 minutes)

Materials: (S) Multiply by 6 (6–10) Pattern Sheet

Note: This activity builds fluency with multiplication facts using units of 6. It works toward students knowing from memory all products of two one-digit numbers. See Lesson 1 for the directions for administration of a Multiply-By Pattern Sheet.

T: (Write  $7 \times 6 = \underline{\quad}$ .) Let's skip-count up by sixes. I'll raise a finger for each six. (Raise a finger for each number to track the count.)

S: 6, 12, 18, 24, 30, 36, 42.

T: Let's skip-count up by sixes starting at 30. Why is 30 a good place to start?

S: It is a fact we already know, so we can use it to figure out a fact we do not know.

T: (Track with fingers as students say the numbers.)

S: 30 (5 fingers), 36 (6 fingers), 42 (7 fingers).

T: Let's see how we can skip-count down to find the answer, too. Start at 60 with 10 fingers, 1 for each six. (Count down with fingers as students say the numbers.)

S: 60 (10 fingers), 54 (9 fingers), 48 (8 fingers), 42 (7 fingers).

Continue with the following possible sequence:  $9 \times 6$ ,  $6 \times 6$ , and  $8 \times 6$ .

T: (Distribute the Multiply by 6 Pattern Sheet.) Let's practice multiplying by 6. Be sure to work left to right across the page.

### Find the Side Lengths (4 minutes)

Materials: (S) Personal white board

Note: This activity reviews Lesson 23.

T: (Project the triangle image. Beneath it, write \_\_\_ cm  $\div$  \_\_\_ = \_\_\_ cm.) Each side of the triangle is the same length. The perimeter of this shape is 24 cm. Find the side lengths of each triangle by filling in the missing numbers.

S: (Write  $24 \text{ cm} \div 6 = 4 \text{ cm}$ .)

Continue the process for the other images, which are composed of squares.

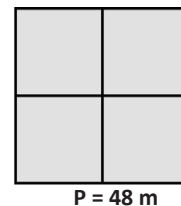
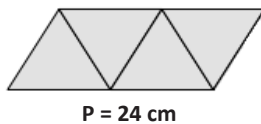

#### NOTES ON MULTIPLE MEANS OF REPRESENTATION:

Students who have difficulty seeing the projected images may construct them from pattern blocks at their desks.

### Concept Development (38 minutes)

Materials: (S) Problem Set, personal white board

Note: The whole-class portion of the Concept Development should take about 15 minutes, with the remainder of the time allotted to be used for completing the Problem Set. Save today's Problem Set for use in Lessons 25–26.

T: Today, you will use all you have learned about perimeter and area to start designing a robot and an environment for it. We'll work on this for four days, so today we will just do our planning. Read the directions for completing the chart on the first page of the Problem Set.

S: (Read: Use the given perimeters in the chart below to choose the widths and lengths of your robot's rectangular body parts. Write the widths and lengths in the chart below. Use the blank rows if you want to add extra rectangular body parts to your robot.)

T: We will not be working with fractional units, only whole numbers, throughout the project. Talk to a partner. How can you use the given perimeters to find possible widths and lengths of each robot body part?



#### NOTES ON MULTIPLE MEANS OF ACTION AND EXPRESSION:

When introducing and giving instructions for designing a robot and its environment, it may be necessary to make certain adjustments for English language learners. Speaking slower, pausing more frequently, giving an example, using visual aids or gestures while checking for understanding, and explaining in students' first languages may prove helpful.

- S: I can find half of the perimeter and then find pairs of numbers that add up to half of the perimeter. These pairs of numbers are the possible widths and lengths.
- T: Do that now for the perimeter of one of your robot's arms, 14 centimeters. (Allow time for students to work.) How many rectangles can you make for that perimeter with whole number side lengths?

S: Three rectangles!

T: Sketch the rectangles, and then compare them to decide which one to use for your robot's arm. Record the width and length of your choice in the chart.

S: (Sketch the rectangles and record choices in the chart.)

T: Look at the chart on page 2 of your Problem Set. Why are some of the width and length spaces shaded in?

S: They are circles, so they do not have length and width. → We do not know how to use the perimeter of a circle to find its width and length. → Circles do not even have a width and length.

T: So, do you have to write anything in your chart for the widths and lengths of the circular items?

S: No!

T: What is the given perimeter of the robot's house?

S: 82 centimeters.

T: What is half of 82?

S: 41.

T: Think about finding the pairs of numbers that add to 41 (or writing all the doubles to 82, depending on which strategy you taught in Lesson 20).

S: That is a lot of pairs of numbers! → It will take a long time, and it seems easy to miss one.

T: Talk to a partner: If you want a tall, skinny house for your robot, will the difference between the width and length be big or small? How do you know?

S: It will be big. A big difference between the width and length makes a tall and skinny rectangle. → That is true. When the difference is small, the rectangle starts to look like a square.

T: Keep that in mind when you plan for the robot's house. Instead of listing all the pairs of numbers that add to 41 and then deciding, think about the pairs of numbers that have a sum of 41 that will make the type of house you want.

Name Gina Date \_\_\_\_\_

Use the given perimeters in the chart below to choose the widths and lengths of your robot's rectangular body parts. Write the widths and lengths in the chart below. Use the blank rows if you want to add extra rectangular body parts to your robot.

Letter	Body Part	Perimeter	Width and Length
A	arm	14 cm	<u>2</u> cm by <u>5</u> cm
B	arm	14 cm	<u>2</u> cm by <u>5</u> cm
C	leg	18 cm	<u>2</u> cm by <u>7</u> cm
D	leg	18 cm	<u>2</u> cm by <u>7</u> cm
E	body	Double the perimeter of one arm = <u>28</u> cm	<u>6</u> cm by <u>8</u> cm
F	head	16 cm	<u>4</u> cm by <u>4</u> cm
G	neck	Half the perimeter of the head = <u>8</u> cm	<u>2</u> cm by <u>2</u> cm
H			_____ cm by _____ cm
I			_____ cm by _____ cm

My robot has 7 to 9 rectangular body parts. Number of body parts: 7

MP.5

Release students to work on their plans for their robots and their robots' environments. Circulate as students work, checking for understanding and clearing up any misconceptions.

### Problem Set (23 minutes)

Students should do their personal best to complete the Problem Set within the allotted 23 minutes. Students who do not finish planning during this time can finish for homework, possibly instead of the Homework provided. Students who finish early may begin constructing their robots.

### Student Debrief (10 minutes)

**Lesson Objective:** Use rectangles to draw a robot with specified perimeter measurements, and reason about the different areas that may be produced.

The Student Debrief is intended to invite reflection and active processing of the total lesson experience.

Invite students to review their solutions for the Problem Set. They should check work by comparing answers with a partner before going over answers as a class. Look for misconceptions or misunderstandings that can be addressed in the Debrief. Guide students in a conversation to debrief the Problem Set and process the lesson.

Any combination of the questions below may be used to lead the discussion.

- Which body part has the greatest perimeter? Why? The smallest perimeter? Why?
- The perimeter of the body is double the perimeter of an arm. Are the width and length of your robot's body double the width and length of its arm? Why or why not?
- The perimeter of the neck is half the perimeter of the head. Are the width and length of your robot's neck half the width and length of its head? Why or why not?
- Explain to a partner how you found the width and length of your robot's house. What shape house will your robot have? How do you know?
- What extra body parts or items for the environment did you plan? What shapes are your extra body parts or items?

Use the information in the chart below to plan an environment for your robot. Write the width and length for each rectangular item. Use the blank rows if you want to add extra circular or rectangular items to your robot's environment.

Letter	Item	Shape	Perimeter	Width and Length
J	sun	circle	about 25 cm	
K	house	rectangle	82 cm	26 cm by 15 cm
L	tree top	circle	about 30 cm	
M	tree trunk	rectangle	30 cm	11 cm by 4 cm
N	tree top	circle	about 20 cm	
O	tree trunk	rectangle	20 cm	7 cm by 3 cm
P				
Q				

My robot's environment has 6 to 8 items. Number of items: 6

### Exit Ticket (3 minutes)

After the Student Debrief, instruct students to complete the Exit Ticket. A review of their work will help with assessing students' understanding of the concepts that were presented in today's lesson and planning more effectively for future lessons. The questions may be read aloud to the students.

Multiply.

$6 \times 1 = \underline{\quad\quad}$      $6 \times 2 = \underline{\quad\quad}$      $6 \times 3 = \underline{\quad\quad}$      $6 \times 4 = \underline{\quad\quad}$

$6 \times 5 = \underline{\quad\quad}$      $6 \times 6 = \underline{\quad\quad}$      $6 \times 7 = \underline{\quad\quad}$      $6 \times 8 = \underline{\quad\quad}$

$6 \times 9 = \underline{\quad\quad}$      $6 \times 10 = \underline{\quad\quad}$      $6 \times 5 = \underline{\quad\quad}$      $6 \times 6 = \underline{\quad\quad}$

$6 \times 5 = \underline{\quad\quad}$      $6 \times 7 = \underline{\quad\quad}$      $6 \times 5 = \underline{\quad\quad}$      $6 \times 8 = \underline{\quad\quad}$

$6 \times 5 = \underline{\quad\quad}$      $6 \times 9 = \underline{\quad\quad}$      $6 \times 5 = \underline{\quad\quad}$      $6 \times 10 = \underline{\quad\quad}$

$6 \times 6 = \underline{\quad\quad}$      $6 \times 5 = \underline{\quad\quad}$      $6 \times 6 = \underline{\quad\quad}$      $6 \times 7 = \underline{\quad\quad}$

$6 \times 6 = \underline{\quad\quad}$      $6 \times 8 = \underline{\quad\quad}$      $6 \times 6 = \underline{\quad\quad}$      $6 \times 9 = \underline{\quad\quad}$

$6 \times 6 = \underline{\quad\quad}$      $6 \times 7 = \underline{\quad\quad}$      $6 \times 6 = \underline{\quad\quad}$      $6 \times 7 = \underline{\quad\quad}$

$6 \times 8 = \underline{\quad\quad}$      $6 \times 7 = \underline{\quad\quad}$      $6 \times 9 = \underline{\quad\quad}$      $6 \times 7 = \underline{\quad\quad}$

$6 \times 8 = \underline{\quad\quad}$      $6 \times 6 = \underline{\quad\quad}$      $6 \times 8 = \underline{\quad\quad}$      $6 \times 7 = \underline{\quad\quad}$

$6 \times 8 = \underline{\quad\quad}$      $6 \times 9 = \underline{\quad\quad}$      $6 \times 9 = \underline{\quad\quad}$      $6 \times 6 = \underline{\quad\quad}$

$6 \times 9 = \underline{\quad\quad}$      $6 \times 7 = \underline{\quad\quad}$      $6 \times 9 = \underline{\quad\quad}$      $6 \times 8 = \underline{\quad\quad}$

$6 \times 9 = \underline{\quad\quad}$      $6 \times 8 = \underline{\quad\quad}$      $6 \times 6 = \underline{\quad\quad}$      $6 \times 9 = \underline{\quad\quad}$

$6 \times 7 = \underline{\quad\quad}$      $6 \times 9 = \underline{\quad\quad}$      $6 \times 6 = \underline{\quad\quad}$      $6 \times 8 = \underline{\quad\quad}$

$6 \times 9 = \underline{\quad\quad}$      $6 \times 7 = \underline{\quad\quad}$      $6 \times 6 = \underline{\quad\quad}$      $6 \times 8 = \underline{\quad\quad}$

multiply by 6 (6–10)

Name \_\_\_\_\_

Date \_\_\_\_\_

Use the given perimeters in the chart below to choose the widths and lengths of your robot's rectangular body parts. Write the widths and lengths in the chart below. Use the blank rows if you want to add extra rectangular body parts to your robot.

Letter	Body Part	Perimeter	Width and Length
A	arm	14 cm	_____ cm by _____ cm
B	arm	14 cm	_____ cm by _____ cm
C	leg	18 cm	_____ cm by _____ cm
D	leg	18 cm	_____ cm by _____ cm
E	body	Double the perimeter of one arm = _____ cm	_____ cm by _____ cm
F	head	16 cm	_____ cm by _____ cm
G	neck	Half the perimeter of the head = _____ cm	_____ cm by _____ cm
H			_____ cm by _____ cm
I			_____ cm by _____ cm
My robot has 7 to 9 rectangular body parts. Number of body parts: _____			

Use the information in the chart below to plan an environment for your robot. Write the width and length for each rectangular item. Use the blank rows if you want to add extra circular or rectangular items to your robot's environment.

Letter	Item	Shape	Perimeter	Width and Length
J	sun	circle	about 25 cm	
K	house	rectangle	82 cm	_____ cm by _____ cm
L	tree top	circle	about 30 cm	
M	tree trunk	rectangle	30 cm	_____ cm by _____ cm
N	tree top	circle	about 20 cm	
O	tree trunk	rectangle	20 cm	_____ cm by _____ cm
P				
Q				
My robot's environment has 6 to 8 items. Number of items: _____				



Name \_\_\_\_\_

Date \_\_\_\_\_

Estimate to draw three different rectangles with a perimeter of 16 centimeters. Label the width and length of each rectangle.



3. The chart below shows the perimeters of three rectangles.
- a. Write possible widths and lengths for each given perimeter.

Rectangle	Perimeter	Width and Length
A	6 cm	_____ cm by _____ cm
B	10 cm	_____ cm by _____ cm
C	14 cm	_____ cm by _____ cm

- b. Double the perimeters of the rectangles in part (a). Then, find possible widths and lengths.

Rectangle	Perimeter	Width and Length
A	12 cm	_____ cm by _____ cm
B		_____ cm by _____ cm
C		_____ cm by _____ cm

## Lesson 25

**Objective:** Use rectangles to draw a robot with specified perimeter measurements, and reason about the different areas that may be produced.

### Suggested Lesson Structure

■ Fluency Practice	(10 minutes)
■ Concept Development	(40 minutes)
■ Student Debrief	(10 minutes)
<b>Total Time</b>	<b>(60 minutes)</b>

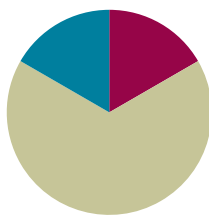

### Fluency Practice (10 minutes)

- Sprint: Multiply or Divide by 6 **3.OA.7** (10 minutes)

### Sprint: Multiply or Divide by 6 (10 minutes)

Materials: (S) Multiply or Divide by 6 Sprint

Note: This Sprint builds fluency with multiplication and division facts using units of 6.

### Concept Development (40 minutes)

Materials: (S) Problem Sets from Lessons 24 and 25, Evaluation Rubric, centimeter grid paper, glue, ruler, right angle tool, crayons, assorted colors of construction paper, 1 piece of 12" × 18" construction paper, string, scissors

Students use today's Problem Set to map out the robot in its environment. Once they have their maps completed, students create just their robots using the widths and lengths they recorded on the Problem Set in Lesson 24. Give them the option of cutting their rectangles out of centimeter grid paper or creating rectangles on construction paper with a right angle tool and ruler. Once all pieces for the robot are cut, students can glue the pieces to a 12" × 18" piece of construction paper.

Finished Robot Sample

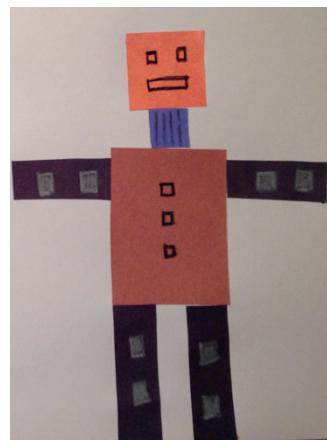

To prepare students:

- Inform students that they will sketch a map of their robot in their environment on the Problem Set. The widths, lengths, and perimeters of the rectangles need to be labeled. Circular items should be labeled with their perimeters. This map will be used again in Lesson 26 as students construct their robot’s environment.
- Inform students they may use either centimeter grid paper or a right angle tool and ruler to create their rectangular robot pieces. Those who use centimeter grid paper might color their pieces if time allows.
- Let students know that their peers will analyze their work. It is important to glue pieces on the 12" × 18" construction paper without affecting the perimeters of the objects, as in Figure A above. Demonstrate that the measurable perimeter of the tree trunk changes with the placement of the tree top in Figure B.
- Inform students that they will have time during the next lesson to put the finishing touches on their robots if they do not have enough time today.
- Share the Evaluation Rubric (pictured to the right and included at the end of the lesson) with students so they know the expectations for the finished product.

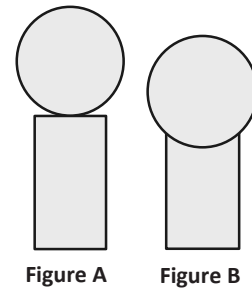

MP.6

4	3	2	1	Subtotal
Perimeter calculations for all shapes are correct, and both evaluations of a classmate’s project have been completed.	Perimeter calculations include 1 to 2 errors, and both evaluations of a classmate’s project have been completed.	Perimeter calculations include 3 to 4 errors, and at least 1 evaluation of a classmate’s project has been completed.	Perimeter calculations include 5 or more errors, and at least 1 evaluation of a classmate’s project has been completed.	____/4

Note: This Evaluation Rubric is for teacher use. Students use a different form to analyze one another’s work for accuracy in Lesson 27. If an anonymous process is preferred for the student analysis, have students identify their work with a number or other symbol, rather than by name.

### Student Debrief (10 minutes)

**Lesson Objective:** Use rectangles to draw a robot with specified perimeter measurements, and reason about the different areas that may be produced.

The Student Debrief is intended to invite reflection and active processing of the total lesson experience.

Invite students to review their solutions for the Problem Set. They should check work by comparing answers with a partner before going over answers as a class. Look for misconceptions or misunderstandings that can be addressed in the Debrief. Guide students in a conversation to debrief the Problem Set and process the lesson.

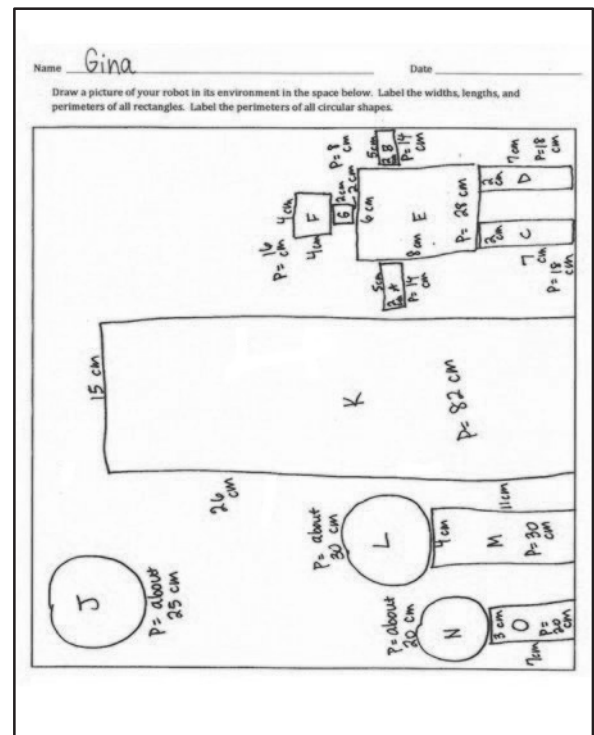

Any combination of the questions below may be used to lead the discussion.

- Compare your drawing to a partner's. What is similar? What is different?
- Which of your shapes looks most like your partner's? Why?
- Even though you all used the same perimeters for the robot's body parts, your robots all look different. How is this possible?
- What was the most difficult part of creating your robot? Why?
- If you did this again, what would you do differently? Why?

**NOTE  
TO TEACHER:**

Students should keep both the Problem Set and their robot art for use in subsequent lessons.

**Exit Ticket (3 minutes)**

After the Student Debrief, instruct students to complete the Exit Ticket. A review of their work will help with assessing students' understanding of the concepts that were presented in today's lesson and planning more effectively for future lessons. The questions may be read aloud to the students.

## A

Number Correct: \_\_\_\_\_

Multiply or Divide by 6

1.	$2 \times 6 =$	
2.	$3 \times 6 =$	
3.	$4 \times 6 =$	
4.	$5 \times 6 =$	
5.	$1 \times 6 =$	
6.	$12 \div 6 =$	
7.	$18 \div 6 =$	
8.	$30 \div 6 =$	
9.	$6 \div 6 =$	
10.	$24 \div 6 =$	
11.	$6 \times 6 =$	
12.	$7 \times 6 =$	
13.	$8 \times 6 =$	
14.	$9 \times 6 =$	
15.	$10 \times 6 =$	
16.	$48 \div 6 =$	
17.	$42 \div 6 =$	
18.	$54 \div 6 =$	
19.	$36 \div 6 =$	
20.	$60 \div 6 =$	
21.	$\underline{\quad} \times 6 = 30$	
22.	$\underline{\quad} \times 6 = 6$	

23.	$\underline{\quad} \times 6 = 60$	
24.	$\underline{\quad} \times 6 = 12$	
25.	$\underline{\quad} \times 6 = 18$	
26.	$60 \div 6 =$	
27.	$30 \div 6 =$	
28.	$6 \div 6 =$	
29.	$12 \div 6 =$	
30.	$18 \div 6 =$	
31.	$\underline{\quad} \times 6 = 36$	
32.	$\underline{\quad} \times 6 = 42$	
33.	$\underline{\quad} \times 6 = 54$	
34.	$\underline{\quad} \times 6 = 48$	
35.	$42 \div 6 =$	
36.	$54 \div 6 =$	
37.	$36 \div 6 =$	
38.	$48 \div 6 =$	
39.	$11 \times 6 =$	
40.	$66 \div 6 =$	
41.	$12 \times 6 =$	
42.	$72 \div 6 =$	
43.	$14 \times 6 =$	
44.	$84 \div 6 =$	

## B

Number Correct: \_\_\_\_\_

Improvement: \_\_\_\_\_

Multiply or Divide by 6

1.	$1 \times 6 =$	
2.	$2 \times 6 =$	
3.	$3 \times 6 =$	
4.	$4 \times 6 =$	
5.	$5 \times 6 =$	
6.	$18 \div 6 =$	
7.	$12 \div 6 =$	
8.	$24 \div 6 =$	
9.	$6 \div 6 =$	
10.	$30 \div 6 =$	
11.	$10 \times 6 =$	
12.	$6 \times 6 =$	
13.	$7 \times 6 =$	
14.	$8 \times 6 =$	
15.	$9 \times 6 =$	
16.	$42 \div 6 =$	
17.	$36 \div 6 =$	
18.	$48 \div 6 =$	
19.	$60 \div 6 =$	
20.	$54 \div 6 =$	
21.	$\underline{\quad} \times 6 = 6$	
22.	$\underline{\quad} \times 6 = 30$	

23.	$\underline{\quad} \times 6 = 12$	
24.	$\underline{\quad} \times 6 = 60$	
25.	$\underline{\quad} \times 6 = 18$	
26.	$12 \div 6 =$	
27.	$6 \div 6 =$	
28.	$60 \div 6 =$	
29.	$30 \div 6 =$	
30.	$18 \div 6 =$	
31.	$\underline{\quad} \times 6 = 18$	
32.	$\underline{\quad} \times 6 = 24$	
33.	$\underline{\quad} \times 6 = 54$	
34.	$\underline{\quad} \times 6 = 42$	
35.	$48 \div 6 =$	
36.	$54 \div 6 =$	
37.	$36 \div 6 =$	
38.	$42 \div 6 =$	
39.	$11 \times 6 =$	
40.	$66 \div 6 =$	
41.	$12 \times 6 =$	
42.	$72 \div 6 =$	
43.	$13 \times 6 =$	
44.	$78 \div 6 =$	



Name \_\_\_\_\_

Date \_\_\_\_\_

Draw a picture of your robot in its environment in the space below. Label the widths, lengths, and perimeters of all rectangles. Label the perimeters of all circular shapes.

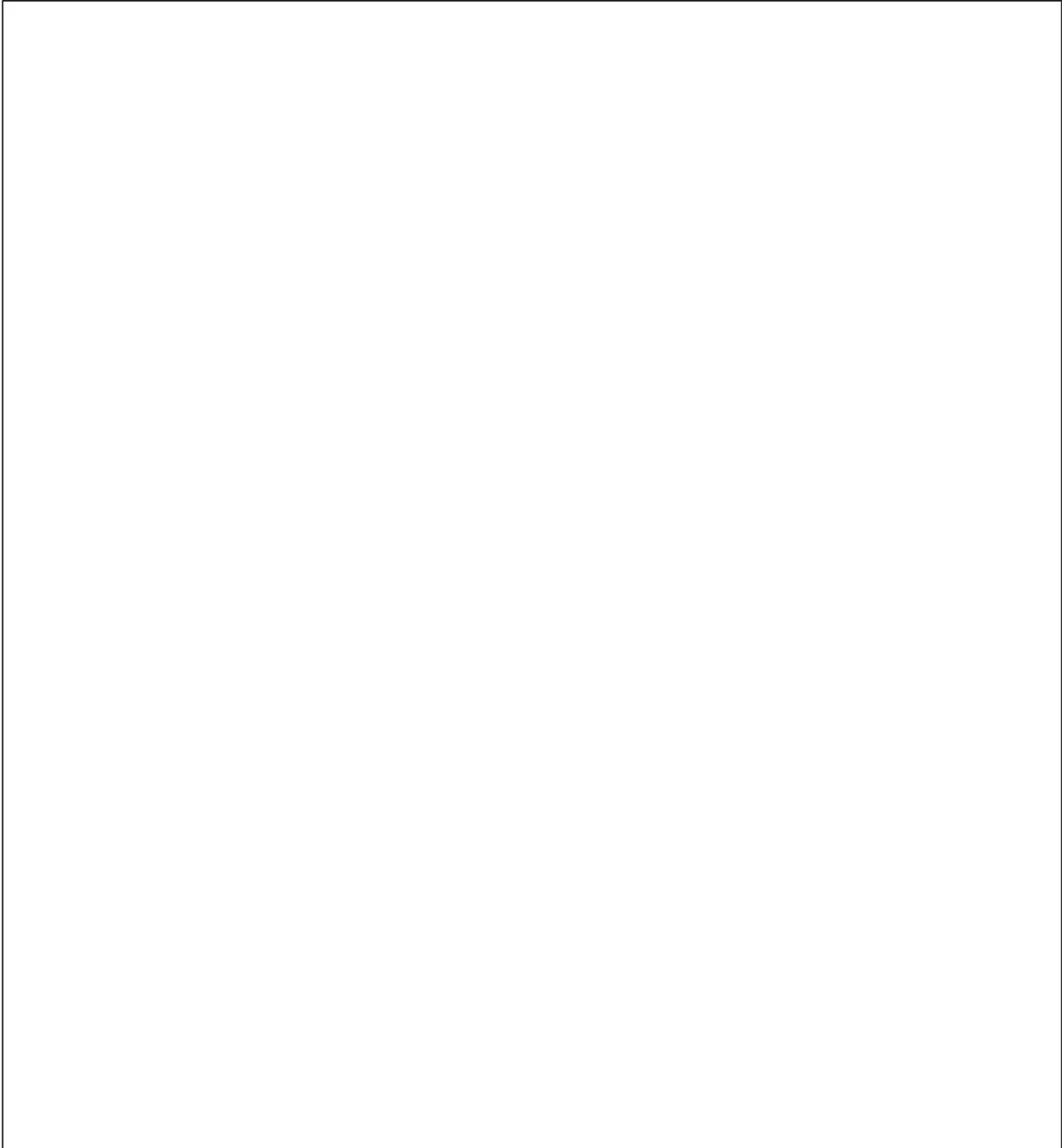

Name \_\_\_\_\_

Date \_\_\_\_\_

1. Sketch rectangles with the following perimeters. Label the side lengths.

a. 22 cm

b. 30 cm

2. Explain the steps you took to create the rectangles with the given perimeters.

Name \_\_\_\_\_

Date \_\_\_\_\_

The robot below is made of rectangles. The side lengths of each rectangle are labeled. Find the perimeter of each rectangle, and record it in the table on the next page.

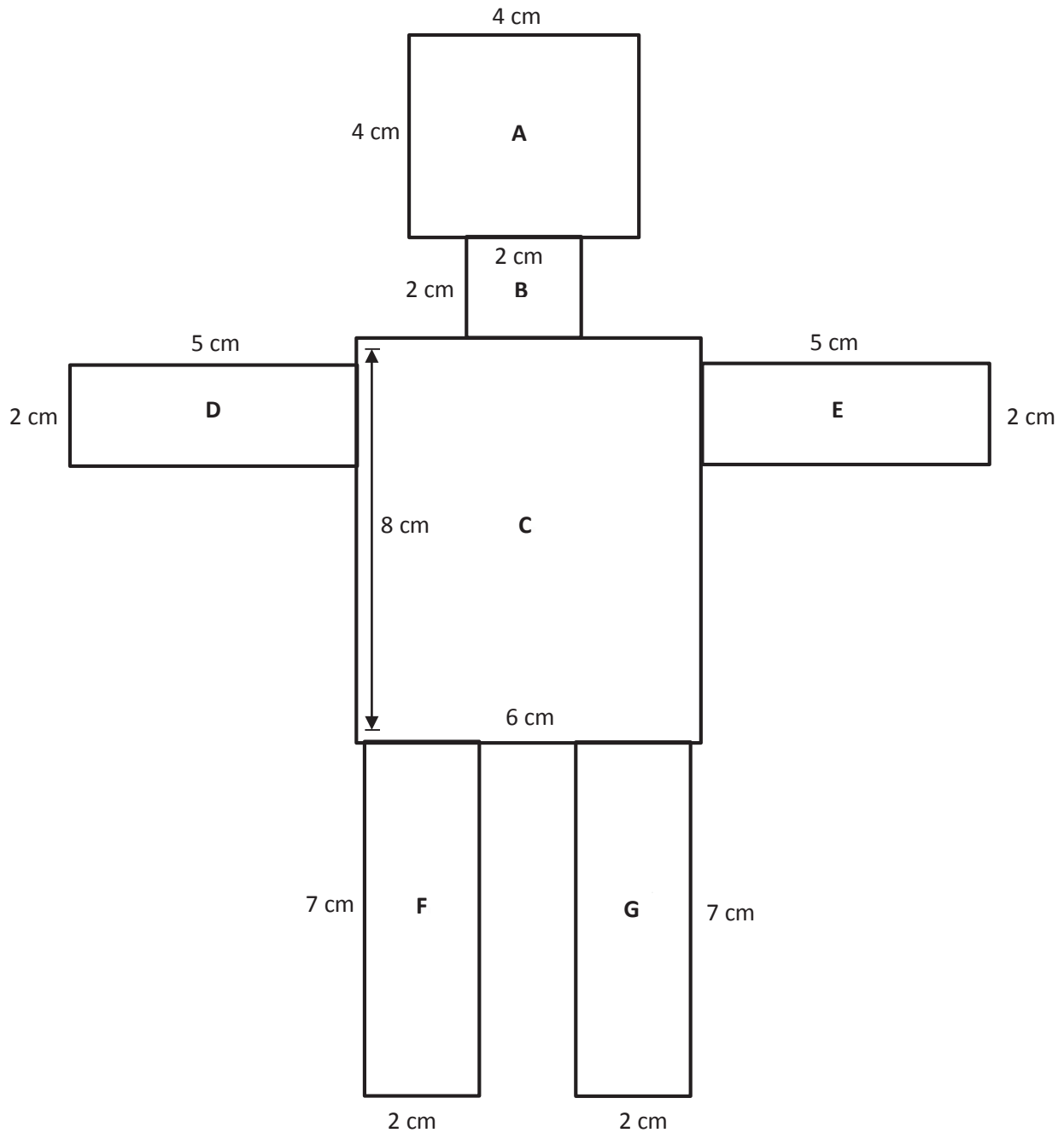

Rectangle	Perimeter
A	$P = 4 \times 4 \text{ cm}$ $P = 16 \text{ cm}$
B	
C	
D	
E	
F	
G	

Name \_\_\_\_\_

Date \_\_\_\_\_

## Evaluation Rubric

4	3	2	1	Subtotal
Perimeter calculations for all shapes are correct, and both evaluations of a classmate's project have been completed.	Perimeter calculations include 1 to 2 errors, and both evaluations of a classmate's project have been completed.	Perimeter calculations include 3 to 4 errors, and at least 1 evaluation of a classmate's project has been completed.	Perimeter calculations include 5 or more errors, and at least 1 evaluation of a classmate's project has been completed.	_____/4

Name \_\_\_\_\_

Date \_\_\_\_\_

## Evaluation Rubric

4	3	2	1	Subtotal
Perimeter calculations for all shapes are correct, and both evaluations of a classmate's project have been completed.	Perimeter calculations include 1 to 2 errors, and both evaluations of a classmate's project have been completed.	Perimeter calculations include 3 to 4 errors, and at least 1 evaluation of a classmate's project has been completed.	Perimeter calculations include 5 or more errors, and at least 1 evaluation of a classmate's project has been completed.	_____/4

## Lesson 26

**Objective:** Use rectangles to draw a robot with specified perimeter measurements, and reason about the different areas that may be produced.

### Suggested Lesson Structure

■ Fluency Practice	(11 minutes)
■ Application Problem	(5 minutes)
■ Concept Development	(34 minutes)
■ Student Debrief	(10 minutes)
<b>Total Time</b>	<b>(60 minutes)</b>

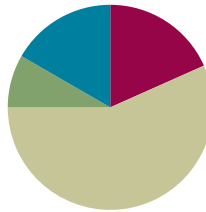

### Fluency Practice (11 minutes)

- Multiply by 7 **3.OA.7** (8 minutes)
- Find the Side Lengths **3.MD.8** (3 minutes)

### Multiply by 7 (8 minutes)

Materials: (S) Multiply by 7 (6–10) Pattern Sheet

Note: This activity builds fluency with multiplication facts using units of 7. It works toward students knowing from memory all products of two one-digit numbers. See Lesson 1 for the directions for administration of a Multiply-By Pattern Sheet.

- T: (Write  $7 \times 7 = \underline{\quad}$ .) Let's skip-count up by sevens. I'll raise a finger for each seven. (Raise a finger for each number to track the count.)
- S: 7, 14, 21, 28, 35, 42, 49.
- T: Let's skip-count up by sevens starting at 35. Why is 35 a good place to start?
- S: It's a fact we already know. It can help us figure out a fact we don't know.
- T: (Track with fingers as students say the numbers.)
- S: 35 (5 fingers), 42 (6 fingers), 49 (7 fingers).



#### NOTES ON MULTIPLE MEANS OF ACTION AND EXPRESSION:

Adjust the Multiply by 7 fluency activity according to student needs. For English language learners, try speaking more slowly, pausing more frequently, giving an example, or coupling language with visual aids such as arrays or tape diagrams. Students who have not memorized the 7 skip-count may benefit from repeating the count many times.

T: Let's see how we can skip-count down to find the answer, too. Start at 70 with 10 fingers, 1 for each seven. (Count down with fingers as students say the numbers.)

S: 70 (10 fingers), 63 (9 fingers), 56 (8 fingers), 49 (7 fingers).

Continue with the following possible sequence:  $9 \times 7$ ,  $6 \times 7$ , and  $8 \times 7$ .

T: (Distribute the Multiply by 7 Pattern Sheet.) Let's practice multiplying by 7. Be sure to work left to right across the page.

### Find the Side Lengths (3 minutes)

Materials: (S) Personal white board

Note: This activity reviews Lesson 23.

T: (Project Image A. Beneath it, write  $\_\_\_ \text{ cm} \div \_\_\_ = \_\_\_ \text{ cm}$ .) Each side of the triangle is the same length. The perimeter of this shape is 80 cm. Find the side lengths of each triangle by filling in the missing numbers.

S: (Write  $80 \text{ cm} \div 8 = 10 \text{ cm}$ .)

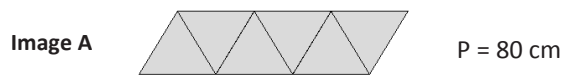

Repeat the process for Images B and C, which are composed of squares and regular pentagons.

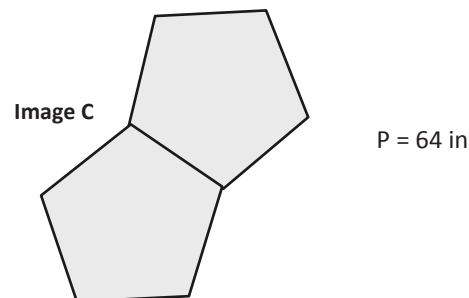
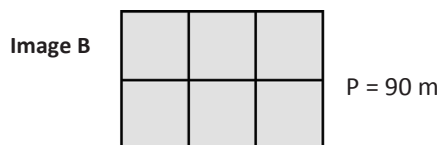

#### NOTES ON MULTIPLE MEANS OF ENGAGEMENT:

Scaffold the Find the Side Lengths fluency activity for students working below grade level with graduated questioning.

- What is the perimeter of Image A? Each triangle side is the same length.
- How many triangle sides do you count around the perimeter? Count with me.
- Say the division sentence to solve for the side length.

### Application Problem (5 minutes)

Drew makes rectangular shoes for his robot. Each shoe has whole number side lengths and an area of 7 square centimeters. What is the total perimeter of both shoes? Is there more than one answer? Why or why not?

Note: Today's Application Problem reviews finding the perimeter of a rectangle given its area. Students find there is only one answer in this case because there is only one factor pair for an area of 7.

Area: 7 sq cm

$$1 \times 7 = 7$$

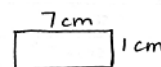

$$P = 7\text{cm} + 1\text{cm} + 7\text{cm} + 1\text{cm}$$

$$P = 8\text{cm} + 8\text{cm}$$

$$P = 16\text{cm}$$

$$\begin{aligned} \text{Perimeter of 2 shoes} &= 16\text{cm} + 16\text{cm} \\ &= 32\text{cm} \end{aligned}$$

The total perimeter for both shoes is 32cm. There is 1 possible answer because we can only build 1 rectangle with an area of 7 sq cm.

## Concept Development (34 minutes)

Materials: (S) Ruler, scissors, string, Problem Sets from Lessons 25 and 26, circles (A–F) (Template)

### Part 1: Create a robot environment.

Students begin with their Lesson 25 Problem Sets.

- T: Today, we will use the map you sketched and labeled on yesterday's Problem Set to measure and cut out the items in your robot's environment. Tell your partner the first step in making circular items.
- S: First, I'll measure string using a ruler and cut it to the size of each circular item.
- T: What three measurements do you need to mark and cut using your strings?
- S: 25, 30, and 20 centimeters. Those are the sizes of the circles in the environment.
- T: Once you have measured and cut your string, it'll be challenging to trace it into circles. I have made a template of circles to help you. (Pass out the circles Template, shown to the right.) What do you notice about the number of circles on your sheet?
- S: There are six circles. But we only need three.
- T: Once you have measured and cut your three strings, match them to the circles on the template you will use to help you trace. Remember that with string, we cannot always be exact. Start measuring now. (Allow students time to measure.) Which circles do we need to cut out and trace to make the circles in our robot's environment?
- S: Circles A, C, and D.
- T: Go ahead and cut, trace, and glue all the pieces to make your robot's environment.
- S: (Measure, trace, cut, and glue the pieces for the environment.)



### NOTES ON MULTIPLE MEANS OF REPRESENTATION:

If helpful, line each circle on the template with glue. Let the glue dry to make a tactile barrier for students as they measure with string.

Demonstrate how to anchor the string and keep it taut around the circle.

Circles (A–F) Template

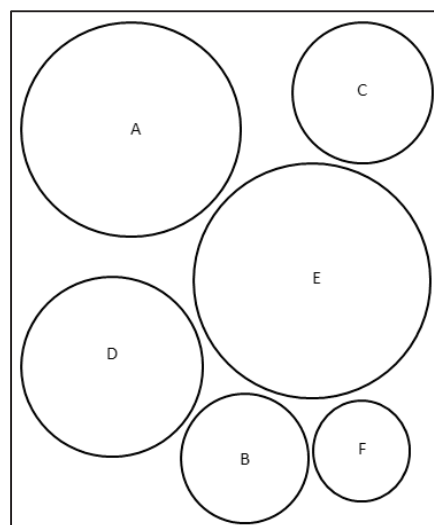

Encourage students who finish early to add details and finishing touches to their work.

### Part 2: Analyze the line plot.

- T: (Distribute the Lesson 26 Problem Set.) Find the area of your robot's rectangular body. Let's plot everyone's data on our number lines.
- T/S: (Gather data, and record the following possible measurements on the line plot: 13, 24, 33, 40, 45, 48, and 49 square centimeters.)
- T: Each robot's body has a perimeter of 28 centimeters. Why do you think we have so many different area measurements for the same perimeter?



- S: (Discuss.)
- T: What does this tell you about the relationship between area and perimeter?
- S: That we can have many different areas for the same perimeter. → They are two separate things. Maybe there is not really a connection between them.
- T: Take some time to record your answers to Problem 1 (a) and (b).
- S: (Record.)

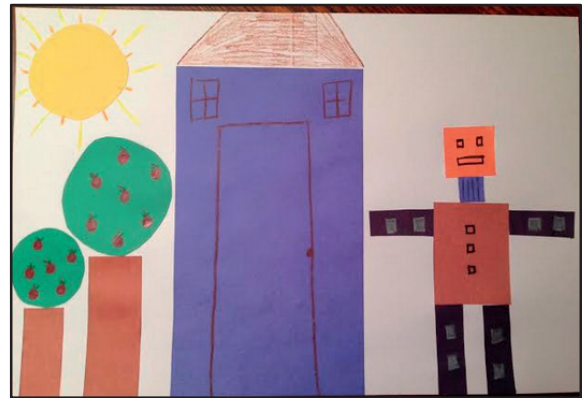

### Problem Set (10 minutes)

Students should do their personal best to complete Problems 2, 3, and 4 within the allotted 10 minutes. For some classes, it may be appropriate to modify the assignment by specifying which problems they work on first. Some problems do not specify a method for solving. Students should solve these problems using the RDW approach used for Application Problems.

### Student Debrief (10 minutes)

**Lesson Objective:** Use rectangles to draw a robot with specified perimeter measurements, and reason about the different areas that may be produced.

The Student Debrief is intended to invite reflection and active processing of the total lesson experience.

Invite students to review their solutions for the Problem Set. They should check work by comparing answers with a partner before going over answers as a class. Look for misconceptions or misunderstandings that can be addressed in the Debrief. Guide students in a conversation to debrief the Problem Set and process the lesson.

Any combination of the questions below may be used to lead the discussion.

- (Share student calculations from Problem 2.) Why do you think the problem asked to measure the perimeter in inches instead of centimeters?
- (Share student sketches in Problem 3.) Discuss that many different shapes can have the same perimeter. Can a triangle and a hexagon have the same perimeter?

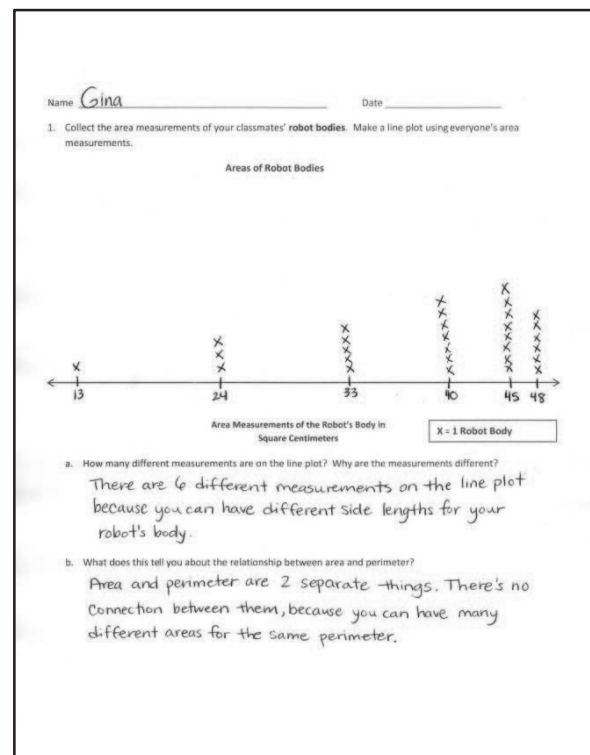

- Have students share their responses to Problem 4.
- Each piece of art looks unique even though you each used the same perimeters. Through this experience, what did you learn about the relationship between area and perimeter?

### Exit Ticket (3 minutes)

After the Student Debrief, instruct students to complete the Exit Ticket. A review of their work will help with assessing students' understanding of the concepts that were presented in today's lesson and planning more effectively for future lessons. The questions may be read aloud to the students.

2. Measure and calculate the perimeter of your construction paper in inches. Show your work below.

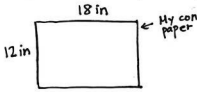

$P = 12\text{ in} + 18\text{ in} + 12\text{ in} + 18\text{ in}$   
 $P = 60\text{ inches}$

3. Sketch and label two shapes with the same perimeter from the robot's environment. What do you notice about the way they look?

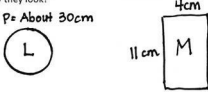

Shapes L and M both have the same perimeter, but are 2 different shapes. Shape L is a circle and Shape M is a rectangle.

4. Write two or three sentences describing your robot and the environment in which it lives.

My robot's name is Marvin. He lives in the deep forest of Machinea. He is very tall! He's taller than most of the trees. He is a friendly robot and loves to be around people and other robots. Maybe you can meet him one day. I know he would love to meet you too!

Multiply.

$7 \times 1 = \underline{\quad\quad\quad}$      $7 \times 2 = \underline{\quad\quad\quad}$      $7 \times 3 = \underline{\quad\quad\quad}$      $7 \times 4 = \underline{\quad\quad\quad}$

$7 \times 5 = \underline{\quad\quad\quad}$      $7 \times 6 = \underline{\quad\quad\quad}$      $7 \times 7 = \underline{\quad\quad\quad}$      $7 \times 8 = \underline{\quad\quad\quad}$

$7 \times 9 = \underline{\quad\quad\quad}$      $7 \times 10 = \underline{\quad\quad\quad}$      $7 \times 5 = \underline{\quad\quad\quad}$      $7 \times 6 = \underline{\quad\quad\quad}$

$7 \times 5 = \underline{\quad\quad\quad}$      $7 \times 7 = \underline{\quad\quad\quad}$      $7 \times 5 = \underline{\quad\quad\quad}$      $7 \times 8 = \underline{\quad\quad\quad}$

$7 \times 5 = \underline{\quad\quad\quad}$      $7 \times 9 = \underline{\quad\quad\quad}$      $7 \times 5 = \underline{\quad\quad\quad}$      $7 \times 10 = \underline{\quad\quad\quad}$

$7 \times 6 = \underline{\quad\quad\quad}$      $7 \times 5 = \underline{\quad\quad\quad}$      $7 \times 6 = \underline{\quad\quad\quad}$      $7 \times 7 = \underline{\quad\quad\quad}$

$7 \times 6 = \underline{\quad\quad\quad}$      $7 \times 8 = \underline{\quad\quad\quad}$      $7 \times 6 = \underline{\quad\quad\quad}$      $7 \times 9 = \underline{\quad\quad\quad}$

$7 \times 6 = \underline{\quad\quad\quad}$      $7 \times 7 = \underline{\quad\quad\quad}$      $7 \times 6 = \underline{\quad\quad\quad}$      $7 \times 7 = \underline{\quad\quad\quad}$

$7 \times 8 = \underline{\quad\quad\quad}$      $7 \times 7 = \underline{\quad\quad\quad}$      $7 \times 9 = \underline{\quad\quad\quad}$      $7 \times 7 = \underline{\quad\quad\quad}$

$7 \times 8 = \underline{\quad\quad\quad}$      $7 \times 6 = \underline{\quad\quad\quad}$      $7 \times 8 = \underline{\quad\quad\quad}$      $7 \times 7 = \underline{\quad\quad\quad}$

$7 \times 8 = \underline{\quad\quad\quad}$      $7 \times 9 = \underline{\quad\quad\quad}$      $7 \times 9 = \underline{\quad\quad\quad}$      $7 \times 6 = \underline{\quad\quad\quad}$

$7 \times 9 = \underline{\quad\quad\quad}$      $7 \times 7 = \underline{\quad\quad\quad}$      $7 \times 9 = \underline{\quad\quad\quad}$      $7 \times 8 = \underline{\quad\quad\quad}$

$7 \times 9 = \underline{\quad\quad\quad}$      $7 \times 8 = \underline{\quad\quad\quad}$      $7 \times 6 = \underline{\quad\quad\quad}$      $7 \times 9 = \underline{\quad\quad\quad}$

$7 \times 7 = \underline{\quad\quad\quad}$      $7 \times 9 = \underline{\quad\quad\quad}$      $7 \times 6 = \underline{\quad\quad\quad}$      $7 \times 8 = \underline{\quad\quad\quad}$

$7 \times 9 = \underline{\quad\quad\quad}$      $7 \times 7 = \underline{\quad\quad\quad}$      $7 \times 6 = \underline{\quad\quad\quad}$      $7 \times 8 = \underline{\quad\quad\quad}$

multiply by 7 (6–10)

Name \_\_\_\_\_

Date \_\_\_\_\_

1. Collect the area measurements of your classmates' **robot bodies**. Make a line plot using everyone's area measurements.

**Areas of Robot Bodies**

Area Measurements of the Robot's Body in  
Square Centimeters

<b>X = 1 Robot Body</b>
-------------------------

- a. How many different measurements are on the line plot? Why are the measurements different?
  
  
  
  
  
  
  
  
  
  
- b. What does this tell you about the relationship between area and perimeter?





Name \_\_\_\_\_

Date \_\_\_\_\_

1. Use Rectangles A and B to answer the questions below.

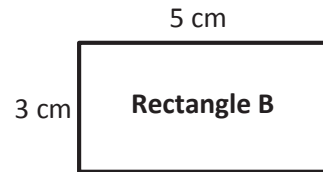
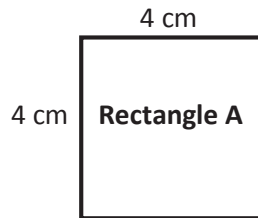

- What is the perimeter of Rectangle A?
- What is the perimeter of Rectangle B?
- What is the area of Rectangle A?
- What is the area of Rectangle B?
- Use your answers to parts (a–d) to help you explain the relationship between area and perimeter.

2. Each student in Mrs. Dutra's class draws a rectangle with whole number side lengths and a perimeter of 28 centimeters. Then, they find the area of each rectangle and create the table below.

Area in Square Centimeters	Number of Students
13	2
24	1
33	3
40	5
45	4
48	2
49	2

- a. Give two examples from Mrs. Dutra's class to show how it is possible to have different areas for rectangles that have the same perimeter.
- b. Did any students in Mrs. Dutra's class draw a square? Explain how you know.
- c. What are the side lengths of the rectangle that most students in Mrs. Dutra's class made with a perimeter of 28 centimeters?



Note: Print on cardstock.

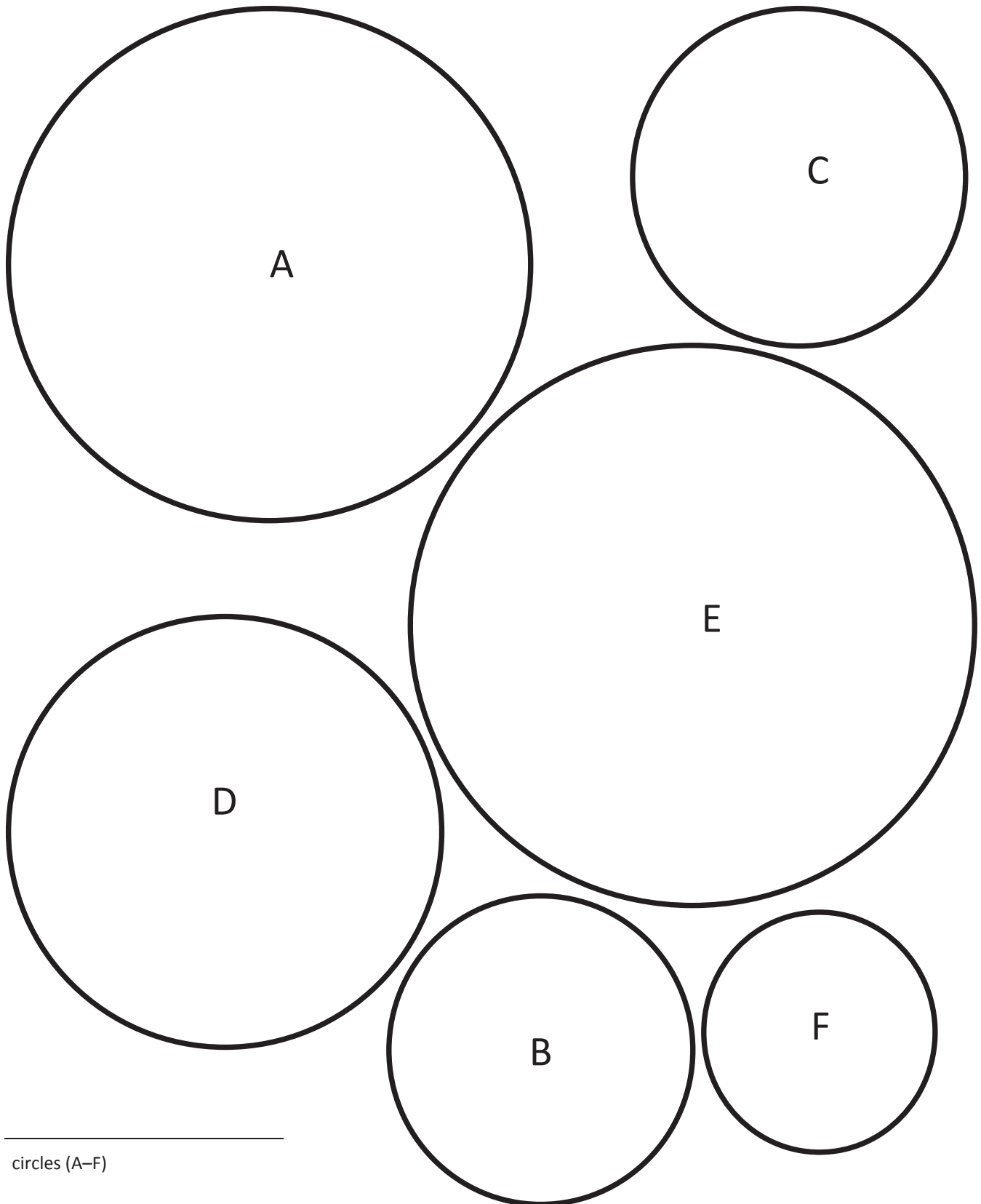

---

circles (A–F)

## Lesson 27

**Objective:** Use rectangles to draw a robot with specified perimeter measurements, and reason about the different areas that may be produced.

### Suggested Lesson Structure

■ Fluency Practice	(14 minutes)
■ Concept Development	(36 minutes)
■ Student Debrief	(10 minutes)
<b>Total Time</b>	<b>(60 minutes)</b>

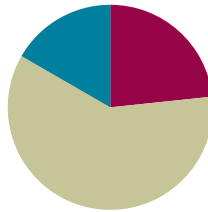

### Fluency Practice (14 minutes)

- Sprint: Multiply or Divide by 7 **3.OA.7** (10 minutes)
- Find the Area **3.MD.7** (4 minutes)

#### Sprint: Multiply or Divide by 7 (10 minutes)

Materials: (S) Multiply or Divide by 7 Sprint

Note: This Sprint builds fluency with multiplication and division facts using units of seven.

#### Find the Area (4 minutes)

Materials: (S) Personal white board

Note: This activity reviews Lesson 19.

- T: (Project the rectangle with a width of 2 cm. Inside the rectangle, write Perimeter = 10 cm.) On your personal white board, write the length of this rectangle.
- S: (Write 3 cm.)
- T: (Write 3 cm on the length of the rectangle. Below the rectangle, write Area = \_\_\_\_.) On your board, write the area of this rectangle. Write a multiplication sentence if you need to.
- S: (Write Area = 6 sq cm.)
- T: Draw a different rectangle that has the same area.
- S: (Draw a 1 cm × 6 cm rectangle.)



#### NOTES ON MULTIPLE MEANS OF ENGAGEMENT:

One way to differentiate the Multiply or Divide by 7 Sprint for students working above grade level is to make individualized performance goals. Students may enjoy recording and charting their completion time, seeking to improve their speed. Other goals may include good sportsmanship, persistence, high ambition, and leadership. Engage students in discussions of what constitutes excellence.

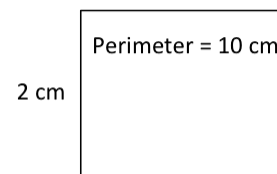

Repeat the process for the other rectangles.

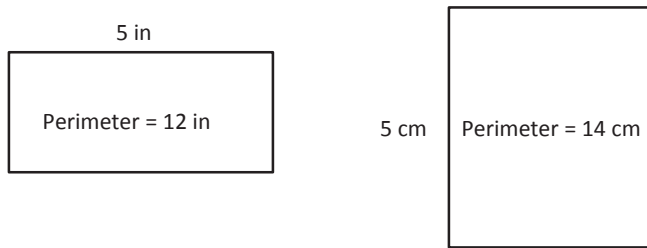

### Concept Development (36 minutes)

Materials: (T) Completed sample robot project, Evaluation Rubric (S) Ruler, 3 strings from Lesson 26, sample Problem Set (Template) (per pair), Problem Set

Note: Students may analyze one another's work anonymously. If that is best for the class, be sure that work is labeled with a number or symbol rather than with student names.

#### Part A: Robot Evaluation

- T: (Project a sample robot as shown to the right. Consider using blank paper to cover the environment to help students focus on the robot.) Here is a finished robot. Let's analyze the work. How can we check the measurements and perimeter calculations?
- S: We can use rulers to check the measurements and then add to double-check the perimeters.
- T: (Pass out the Template, shown to the right.) To analyze the accuracy of this robot, I used my ruler to measure the widths and lengths of each body part and recorded them on the chart in front of you. Then, I calculated the perimeter of Rectangle A and checked it with the required perimeter, labeled in the final column. Check my calculation for Rectangle A. Does it match the required perimeter?
- S: Yes. They are both 14 centimeters.
- T: Work with a partner to finish calculating the rest of the perimeters using the given lengths and widths. If you find that your measurements differ from the required perimeter, put a star by the letter of the rectangle.
- S: (Calculate the perimeters.)
- T: What did you find?
- S: These perimeters are all correct!

Sample Robot



Sample Problem Set Template

Name: Sample Date: \_\_\_\_\_

Part A: I received Student A's robot.

Use the chart below to evaluate your friend's robot. Measure the lengths and widths of each rectangle. Then calculate the perimeter. Record that information in the table below. If your measurements differ from those listed on the project, put a star by the letter of the rectangle.

Rectangle	Width and Length	Student's Perimeter	Required Perimeter
A	<u>2</u> cm by <u>5</u> cm	$2\text{cm} + 2\text{cm} + 5\text{cm} + 5\text{cm} = 14\text{cm}$	14 cm
B	<u>2</u> cm by <u>5</u> cm		14 cm
C	<u>2</u> cm by <u>7</u> cm		18 cm
D	<u>2</u> cm by <u>7</u> cm		18 cm
E	<u>6</u> cm by <u>8</u> cm		28 cm
F	<u>4</u> cm by <u>4</u> cm		16 cm
G	<u>2</u> cm by <u>2</u> cm		8 cm
H	_____ cm by _____ cm		
I	_____ cm by _____ cm		

- T: What is next on our list?
- S: Checking that the body is double the perimeter of an arm and that the neck is half the perimeter of the head.
- T: Do that now. Record your calculations, and then check your answer with a partner's.
- S: (Record.) It is done correctly. A perimeter of 28 centimeters for the robot's body is double 14 centimeters, and 8 centimeters for the robot's neck is half of 16 centimeters.
- T: Each of you will analyze a classmate's robot just as we did this one. Write your classmate's name on your Problem Set. Confirm the measurements and perimeters calculated by your classmate with your ruler. (Distribute a classmate's work to each student, and circulate to answer the questions that arise.)

### Part B: Robot Environment Evaluation

In Part B, students use the same process as in Part A to evaluate a different classmate's robot environment. Each student uses her three strings to measure nonrectangular items like the sun and the tree tops. Make sure to discuss how these circular measurements most likely do not produce exact numbers. Provide examples of perimeter measurements that are appropriate to call *about 25 centimeters*.

If time permits, have students evaluate a different classmate's robot or robot environment.

Sample Robot Environment



### Student Debrief (10 minutes)

**Lesson Objective:** Use rectangles to draw a robot with specified perimeter measurements, and reason about the different areas that may be produced.

The Student Debrief is intended to invite reflection and active processing of the total lesson experience.

Invite students to review their solutions for the Problem Set. They should check work by comparing answers with a partner before going over answers as a class. Look for misconceptions or misunderstandings that can be addressed in the Debrief. Guide students in a conversation to debrief the Problem Set and process the lesson.

Name Gina Date \_\_\_\_\_

Part A: I reviewed Susan's robot.

1. Use the chart below to evaluate your friend's robot. Measure the width and length of each rectangle. Then, calculate the perimeter. Record that information in the table below. If your measurements differ from those listed on the project, put a star by the letter of the rectangle.

Rectangle	Width and Length	Student's Perimeter	Required Perimeter
A	<u>2</u> cm by <u>5</u> cm	$4\text{ cm} + 10\text{ cm} = 14\text{ cm}$	14 cm
B	<u>2</u> cm by <u>5</u> cm	$4\text{ cm} + 10\text{ cm} = 14\text{ cm}$	14 cm
C	<u>2</u> cm by <u>7</u> cm	$4\text{ cm} + 14\text{ cm} = 18\text{ cm}$	18 cm
D	<u>2</u> cm by <u>7</u> cm	$4\text{ cm} + 14\text{ cm} = 18\text{ cm}$	18 cm
E	<u>6</u> cm by <u>8</u> cm	$12\text{ cm} + 16\text{ cm} = 28\text{ cm}$	28 cm
F	<u>4</u> cm by <u>4</u> cm	$8\text{ cm} + 8\text{ cm} = 16\text{ cm}$	16 cm
G	<u>2</u> cm by <u>2</u> cm	$4\text{ cm} + 4\text{ cm} = 8\text{ cm}$	8 cm
H	_____ cm by _____ cm		
I	_____ cm by _____ cm		

Any combination of the questions below may be used to lead the discussion.

MP.3

- How was the student work you checked similar to the design you created? How was it different?
- How was checking the student work different from creating your design yesterday? If you could go back and change your design, would you? If so, in what ways?
- What did you learn about the areas of rectangles that have the same perimeters? How does this help you better understand the relationship between area and perimeter?

### Exit Ticket (3 minutes)

After the Student Debrief, instruct students to complete the Exit Ticket. A review of their work will help with assessing students' understanding of the concepts that were presented in today's lesson and planning more effectively for future lessons. The questions may be read aloud to the students.

2. Is the perimeter of the robot's body double that of the arm? Show calculations below.

$$P \text{ of the body} = 28 \text{ cm}$$

$$P \text{ of 1 arm doubled} = 14 \text{ cm} + 14 \text{ cm} = 28 \text{ cm}$$

Yes, the perimeter of the robot's body is double that of the arm.

3. Is the perimeter of the robot's neck half the perimeter of the head? Show calculations below.

$$P \text{ of robot's neck} = 8 \text{ cm}$$

$$\text{Half the perimeter of robot's head} = 16 \text{ cm} \div 2 = 8 \text{ cm}$$

Both calculations are correct!

Part B: I reviewed Carl's robot environment.

4. Use the chart below to evaluate your friend's robot environment. Measure the width and length of each rectangle. Then, calculate the perimeter. Use your string to measure the perimeters of nonrectangular items. Record that information in the chart below. If your measurements differ from those listed on the project, put a star by the letter of the shape.

Item	Width and Length	Student's Perimeter	Required Perimeter
J		$24\frac{3}{4} \text{ cm} \approx 25 \text{ cm}$	About 25 cm
K	<u>26</u> cm by <u>15</u> cm	$52 \text{ cm} + 30 \text{ cm} = 82 \text{ cm}$	82 cm
L		30 cm	About 30 cm
M	<u>11</u> cm by <u>4</u> cm	$22 \text{ cm} + 8 \text{ cm} = 30 \text{ cm}$	30 cm
N		$19\frac{1}{2} \text{ cm} \approx 20 \text{ cm}$	About 20 cm
O	<u>7</u> cm by <u>3</u> cm	$14 \text{ cm} + 6 \text{ cm} = 20 \text{ cm}$	20 cm
P			
Q			

## A

Number Correct: \_\_\_\_\_

Multiply or Divide by 7

1.	$2 \times 7 =$	
2.	$3 \times 7 =$	
3.	$4 \times 7 =$	
4.	$5 \times 7 =$	
5.	$1 \times 7 =$	
6.	$14 \div 7 =$	
7.	$21 \div 7 =$	
8.	$35 \div 7 =$	
9.	$7 \div 7 =$	
10.	$28 \div 7 =$	
11.	$6 \times 7 =$	
12.	$7 \times 7 =$	
13.	$8 \times 7 =$	
14.	$9 \times 7 =$	
15.	$10 \times 7 =$	
16.	$56 \div 7 =$	
17.	$49 \div 7 =$	
18.	$63 \div 7 =$	
19.	$42 \div 7 =$	
20.	$70 \div 7 =$	
21.	$\underline{\quad} \times 7 = 35$	
22.	$\underline{\quad} \times 7 = 7$	

23.	$\underline{\quad} \times 7 = 70$	
24.	$\underline{\quad} \times 7 = 14$	
25.	$\underline{\quad} \times 7 = 21$	
26.	$70 \div 7 =$	
27.	$35 \div 7 =$	
28.	$7 \div 7 =$	
29.	$14 \div 7 =$	
30.	$21 \div 7 =$	
31.	$\underline{\quad} \times 7 = 42$	
32.	$\underline{\quad} \times 7 = 49$	
33.	$\underline{\quad} \times 7 = 63$	
34.	$\underline{\quad} \times 7 = 56$	
35.	$49 \div 7 =$	
36.	$63 \div 7 =$	
37.	$42 \div 7 =$	
38.	$56 \div 7 =$	
39.	$11 \times 7 =$	
40.	$77 \div 7 =$	
41.	$12 \times 7 =$	
42.	$84 \div 7 =$	
43.	$14 \times 7 =$	
44.	$98 \div 7 =$	

## B

Number Correct: \_\_\_\_\_

Improvement: \_\_\_\_\_

Multiply or Divide by 7

1.	$1 \times 7 =$	
2.	$2 \times 7 =$	
3.	$3 \times 7 =$	
4.	$4 \times 7 =$	
5.	$5 \times 7 =$	
6.	$21 \div 7 =$	
7.	$14 \div 7 =$	
8.	$28 \div 7 =$	
9.	$7 \div 7 =$	
10.	$35 \div 7 =$	
11.	$10 \times 7 =$	
12.	$6 \times 7 =$	
13.	$7 \times 7 =$	
14.	$8 \times 7 =$	
15.	$9 \times 7 =$	
16.	$49 \div 7 =$	
17.	$42 \div 7 =$	
18.	$56 \div 7 =$	
19.	$70 \div 7 =$	
20.	$63 \div 7 =$	
21.	$\underline{\quad} \times 7 = 7$	
22.	$\underline{\quad} \times 7 = 35$	

23.	$\underline{\quad} \times 7 = 14$	
24.	$\underline{\quad} \times 7 = 70$	
25.	$\underline{\quad} \times 7 = 21$	
26.	$14 \div 7 =$	
27.	$7 \div 7 =$	
28.	$70 \div 7 =$	
29.	$35 \div 7 =$	
30.	$21 \div 7 =$	
31.	$\underline{\quad} \times 7 = 21$	
32.	$\underline{\quad} \times 7 = 28$	
33.	$\underline{\quad} \times 7 = 63$	
34.	$\underline{\quad} \times 7 = 49$	
35.	$56 \div 7 =$	
36.	$63 \div 7 =$	
37.	$42 \div 7 =$	
38.	$49 \div 7 =$	
39.	$11 \times 7 =$	
40.	$77 \div 7 =$	
41.	$12 \times 7 =$	
42.	$84 \div 7 =$	
43.	$13 \times 7 =$	
44.	$91 \div 7 =$	

Name \_\_\_\_\_

Date \_\_\_\_\_

**Part A:** I reviewed \_\_\_\_\_'s robot.

1. Use the chart below to evaluate your friend's robot. Measure the width and length of each rectangle. Then, calculate the perimeter. Record that information in the chart below. If your measurements differ from those listed on the project, put a star by the letter of the rectangle.

Rectangle	Width and Length	Student's Perimeter	Required Perimeter
A	_____ cm by _____ cm		14 cm
B	_____ cm by _____ cm		14 cm
C	_____ cm by _____ cm		18 cm
D	_____ cm by _____ cm		18 cm
E	_____ cm by _____ cm		28 cm
F	_____ cm by _____ cm		16 cm
G	_____ cm by _____ cm		8 cm
H	_____ cm by _____ cm		
I	_____ cm by _____ cm		





**Part B:** I reviewed \_\_\_\_\_'s robot environment.

4. Use the chart below to evaluate your friend's robot environment. Measure the width and length of each rectangle. Then, calculate the perimeter. Use your string to measure the perimeters of nonrectangular items. Record that information in the chart below. If your measurements differ from those listed on the project, put a star by the letter of the shape.

Item	Width and Length	Student's Perimeter	Required Perimeter
J			About 25 cm
K	_____ cm by _____ cm		82 cm
L			About 30 cm
M	_____ cm by _____ cm		30 cm
N			About 20 cm
O	_____ cm by _____ cm		20 cm
P			
Q			

Name \_\_\_\_\_

Date \_\_\_\_\_

1. Record the perimeters and areas of Rectangles A and B in the chart below.

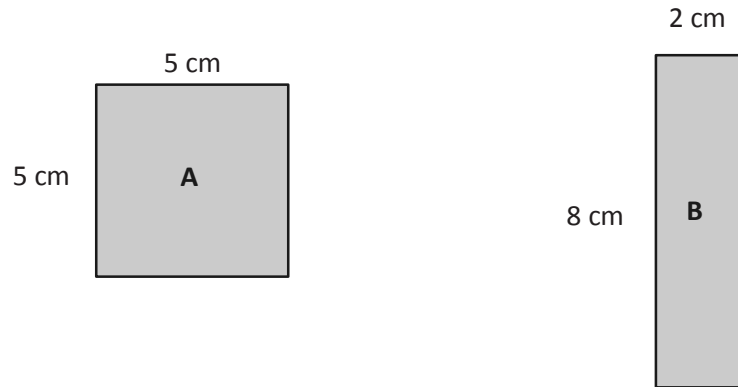

Rectangle:	Width and Length:	Perimeter	Area
A	_____ cm by _____ cm		
B	_____ cm by _____ cm		

2. What is the same about Rectables A and B? What is different?

Name \_\_\_\_\_

Date \_\_\_\_\_

Record the perimeters and areas of the rectangles in the chart on the next page.

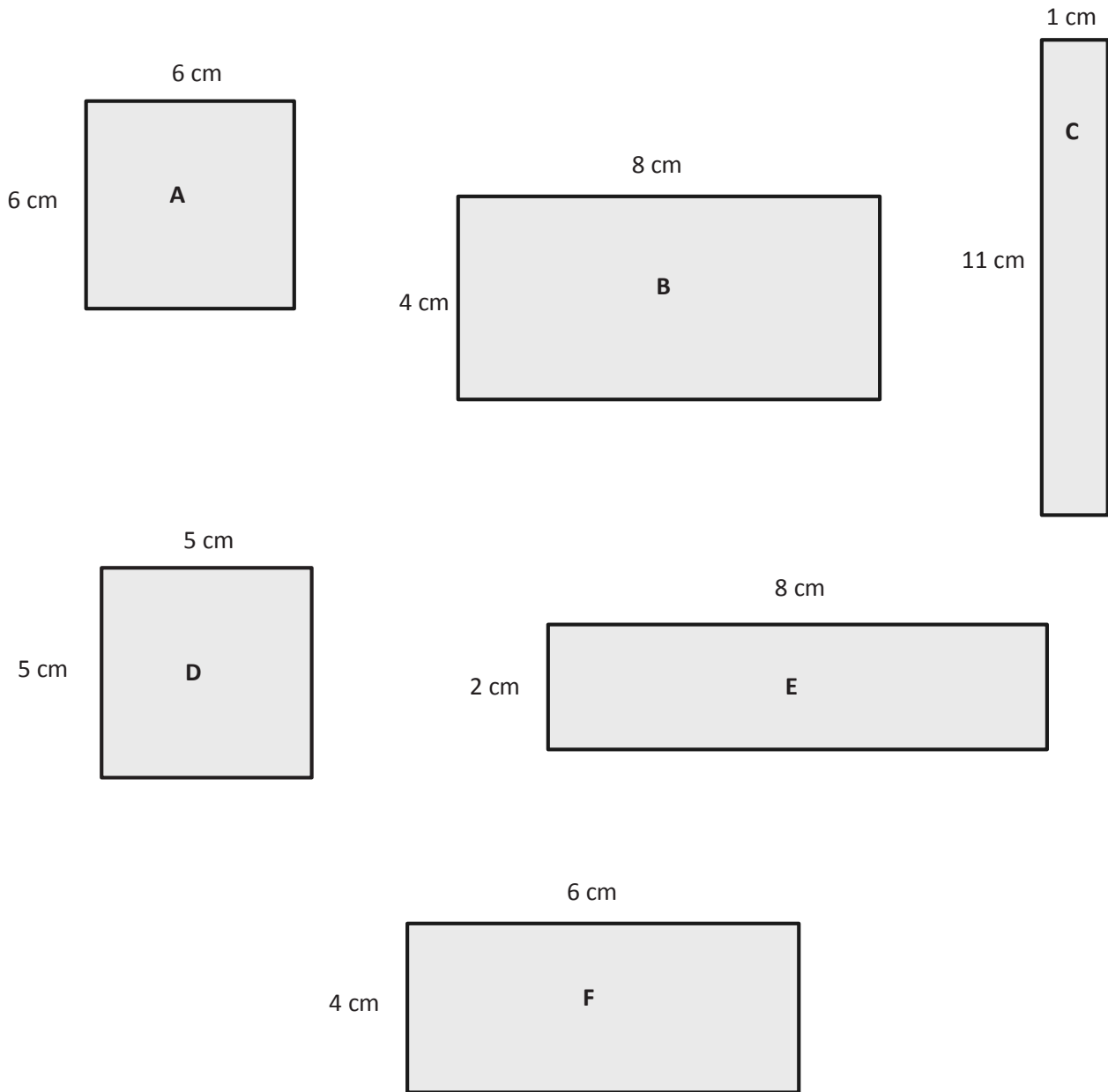

1. Find the area and perimeter of each rectangle.

Rectangle	Width and Length	Perimeter	Area
A	_____ cm by _____ cm		
B	_____ cm by _____ cm		
C	_____ cm by _____ cm		
D	_____ cm by _____ cm		
E	_____ cm by _____ cm		
F	_____ cm by _____ cm		

2. What do you notice about the perimeters of Rectangles A, B, and C?
3. What do you notice about the perimeters of Rectangles D, E, and F?
4. Which two rectangles are squares? Which square has the greater perimeter?

Name \_\_\_\_\_

Date \_\_\_\_\_

## Evaluation Rubric

4	3	2	1	Subtotal
Perimeter calculations for all shapes are correct, and both evaluations of a classmate's project have been completed.	Perimeter calculations include 1 to 2 errors, and both evaluations of a classmate's project have been completed.	Perimeter calculations include 3 to 4 errors, and at least 1 evaluation of a classmate's project has been completed.	Perimeter calculations include 5 or more errors, and at least 1 evaluation of a classmate's project has been completed.	_____/4

Name \_\_\_\_\_

Date \_\_\_\_\_

## Evaluation Rubric

4	3	2	1	Subtotal
Perimeter calculations for all shapes are correct, and both evaluations of a classmate's project have been completed.	Perimeter calculations include 1 to 2 errors, and both evaluations of a classmate's project have been completed.	Perimeter calculations include 3 to 4 errors, and at least 1 evaluation of a classmate's project has been completed.	Perimeter calculations include 5 or more errors, and at least 1 evaluation of a classmate's project has been completed.	_____/4

Name Sample Date \_\_\_\_\_

Part A: I reviewed Student A's robot.

Use the chart below to evaluate your friend's robot. Measure the lengths and widths of each rectangle. Then calculate the perimeter. Record that information in the table below. If your measurements differ from those listed on the project, put a star by the letter of the rectangle.

Rectangle	Width and Length	Student's Perimeter	Required Perimeter
A	<u>2</u> cm by <u>5</u> cm	$2\text{cm} + 2\text{cm} + 5\text{cm} + 5\text{cm} = 14\text{cm}$	14 cm
B	<u>2</u> cm by <u>5</u> cm		14 cm
C	<u>2</u> cm by <u>7</u> cm		18 cm
D	<u>2</u> cm by <u>7</u> cm		18 cm
E	<u>6</u> cm by <u>8</u> cm		28 cm
F	<u>4</u> cm by <u>4</u> cm		16 cm
G	<u>2</u> cm by <u>2</u> cm		8 cm
H	_____ cm by _____ cm		
I	_____ cm by _____ cm		

sample Problem Set

## Lesson 28

**Objective:** Solve a variety of word problems involving area and perimeter using all four operations.

### Suggested Lesson Structure

■ Fluency Practice	(12 minutes)
■ Concept Development	(38 minutes)
■ Student Debrief	(10 minutes)
<b>Total Time</b>	<b>(60 minutes)</b>

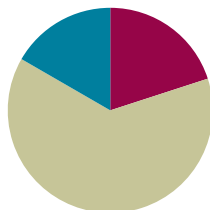

### Fluency Practice (12 minutes)

- Multiply by 8 **3.OA.7** (8 minutes)
- Find the Perimeter **3.MD.8** (4 minutes)

### Multiply by 8 (8 minutes)

Materials: (S) Multiply by 8 (6–10) Pattern Sheet

Note: This activity builds fluency with multiplication facts using units of 8. It works toward students knowing from memory all products of two one-digit numbers. See Lesson 1 for the directions for administration of a Multiply-By Pattern Sheet.

- T: (Write  $7 \times 8 = \underline{\quad}$ .) Let's skip-count up by eights. I'll raise a finger for each eight. (Raise a finger for each number to track the count.)
- S: 8, 16, 24, 32, 40, 48, 56.
- T: Let's skip-count up by eights starting at 40. Why is 40 a good place to start?
- S: It is a fact we already know, so we can use it to figure out a fact we do not know.
- T: (Track with fingers as students say the numbers.)
- S: 40 (5 fingers), 48 (6 fingers), 56 (7 fingers).
- T: Let's see how we can skip-count down to find the answer, too. Start at 80 with 10 fingers, 1 for each eight. (Count down with fingers as students say the numbers.)
- S: 80 (10 fingers), 72 (9 fingers), 64 (8 fingers), 56 (7 fingers).

Continue with the following possible sequence:  $9 \times 8$ ,  $6 \times 8$ , and  $8 \times 8$ .

- T: (Distribute the Multiply by 8 Pattern Sheet.) Let's practice multiplying by 8. Be sure to work left to right across the page.



**Find the Perimeter (4 minutes)**

Materials: (S) Personal white board

Note: This activity prepares students for the word problems in today's Concept Development.

- T: (Project the rectangle with a width of 2 cm. Inside the rectangle, write Area = 10 sq cm.) On your personal white board, write the length of this rectangle.
- S: (Write 5 cm.)
- T: (Write 5 cm on the length of the rectangle. Below the rectangle, write Perimeter = \_\_\_\_.) On your board, write the perimeter of this rectangle. Write a four-step addition sentence if you need to.
- S: (Write Perimeter = 14 cm.)
- T: On your board, sketch a rectangle that has an area of 10 square cm but different side lengths from this rectangle.
- S: (Sketch a rectangle with side lengths of 1 cm and 10 cm.)
- T: (Write Perimeter = \_\_\_\_.) Calculate the perimeter of the new rectangle.
- S: (Write Perimeter = 22 cm.)

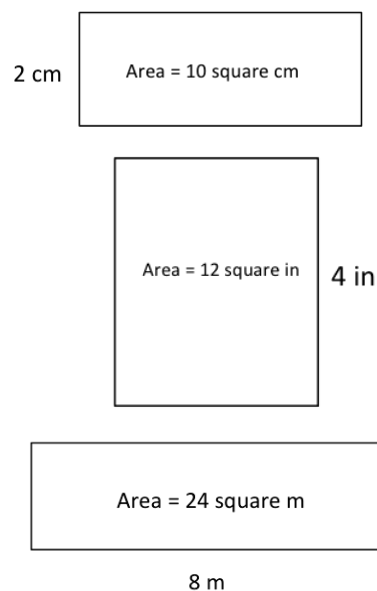

Repeat the process for the other rectangles.

**Concept Development (38 minutes)**

Materials: (S) Problem Set

Note: Save this lesson's Problem Set for use in Lesson 30.

MP.1

This is a problem-solving lesson in which students work in pairs or independently to solve the four problems on the Problem Set. Consider using the three-step approach outlined in Lesson 23 to guide them through solving (the basic steps are shown below). Specific information about each problem follows and can be used to further facilitate conversation.

Three-Step Approach to Solving:

1. Read and model.
2. Write an equation, calculate to solve, and write a statement.
3. Assess the solution for reasonableness.



**NOTES ON  
MULTIPLE MEANS  
OF ACTION AND  
EXPRESSION:**

Students who have not memorized 7, 8, and 9 facts may benefit from using strategies to solve the word problems on the Problem Set. Encourage students to use personally efficient strategies, such as counting up from familiar facts (as practiced in the Multiply by 8 fluency activity) and the distributive property.

Note: This Problem Set breaks each question into several parts to provide a scaffold for students to solve a variety of word problems involving area and perimeter. This helps ease students into the more challenging word problems in Lesson 29.

**Problem 1: Gia measures her rectangular garden and finds the width is 9 yards and the length is 7 yards.**

- Estimate to draw Gia's garden, and label the side lengths.
- What is the area of Gia's garden?
- What is the perimeter of Gia's garden?

This first problem provides a simple, straightforward start to the set. It allows students to begin problem solving confidently and successfully.

**Problem 2: Elijah draws a square that has side lengths of 8 centimeters.**

- Estimate to draw Elijah's square, and label the side lengths.
- What is the area of Elijah's square?
- What is the perimeter of Elijah's square?
- Elijah connects three of these squares to make one long rectangle. What is the perimeter of this rectangle?

Students should recognize the side lengths of a square are all equal. Part (d) provides the complexity in this problem. When Elijah connects three of these squares to make one long rectangle, students need to recognize that the length of the rectangle continues to be 8 centimeters, but the width is now tripled to 24 centimeters. They then add the new side lengths to find the perimeter of the rectangle, 64 centimeters. A misconception in part (d) may be thinking that the perimeter of the rectangle can be found by multiplying the perimeter of the square by 3.

**Problem 3: The area of Mason's rectangular painting is 72 square inches. The width of the painting is 8 inches.**

- Estimate to draw Mason's painting, and label the side lengths.
- What is the length of the painting?

Name Gina Date \_\_\_\_\_

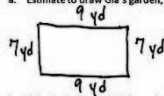
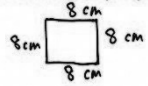
- Gia measures her rectangular garden and finds the width is 9 yards and the length is 7 yards.
  - Estimate to draw Gia's garden, and label the side lengths.
 
  - What is the area of Gia's garden?
 
$$7 \text{ yd} \times 9 \text{ yd} = 63 \text{ sq yd}$$
 The area of Gia's garden is 63 square yards.
  - What is the perimeter of Gia's garden?
 
$$7 \text{ yd} + 7 \text{ yd} + 9 \text{ yd} + 9 \text{ yd} = 32 \text{ yd}$$
 The perimeter of Gia's garden is 32 yards.
- Elijah draws a square that has side lengths of 8 centimeters.
  - Estimate to draw Elijah's square, and label the side lengths.
 
  - What is the area of Elijah's square?
 
$$8 \text{ cm} \times 8 \text{ cm} = 64 \text{ sq cm}$$
 The area of Elijah's square is 64 square centimeters.
  - What is the perimeter of Elijah's square?
 
$$8 \text{ cm} + 8 \text{ cm} + 8 \text{ cm} + 8 \text{ cm} = 32 \text{ cm}$$
 The perimeter of Elijah's square is 32 centimeters.

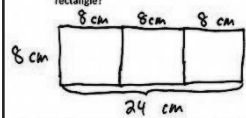
- Elijah connects three of these squares to make one long rectangle. What is the perimeter of this rectangle?
 

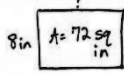
$$P = 24 \text{ cm} + 24 \text{ cm} + 8 \text{ cm} + 8 \text{ cm} = 64 \text{ cm}$$
 The perimeter of this rectangle is 64 centimeters.
- The area of Mason's rectangular painting is 72 square inches. The width of the painting is 8 inches.
  - Estimate to draw Mason's painting, and label the side lengths.
 
  - What is the length of the painting?
 
$$\text{length} = 72 \text{ sq in} \div 8 \text{ in} = 9 \text{ in}$$
 The length of the painting is 9 inches.
  - What is the perimeter of Mason's painting?
 
$$P = 8 \text{ in} + 8 \text{ in} + 9 \text{ in} + 9 \text{ in} = 34 \text{ in}$$
 The perimeter of Mason's painting is 34 inches.
  - Mason's mom hangs the painting on a wall that already has two of Mason's other paintings. The areas of the other paintings are 64 square inches and 81 square inches. What is the total area of the wall that is covered with Mason's paintings?
 
$$\text{Total area} = 64 \text{ sq in} + 81 \text{ sq in} + 72 \text{ sq in} = 217 \text{ sq in}$$
 The total area of the wall that is covered with Mason's paintings is 217 square inches.

- c. What is the perimeter of Mason's painting?
- d. Mason's mom hangs the painting on a wall that already has two of Mason's other paintings. The areas of the other paintings are 64 square inches and 81 square inches. What is the total area of the wall that is covered with Mason's paintings?

To find the unknown length, students may write a division problem or an unknown factor problem. A misconception in part (d) may be thinking that the total area is found by adding 64 square inches plus 81 square inches and forgetting about Mason's original painting since the third area is not stated directly in the problem.

**Problem 4: The perimeter of Jillian's rectangular bedroom is 34 feet. The length of her bedroom is 9 feet.**

- a. Estimate to draw Jillian's bedroom, and label the side lengths.
- b. What is the width of Jillian's bedroom?
- c. What is the area of Jillian's bedroom?
- d. Jillian has a 4-foot by 6-foot rug in her room. What is the area of the floor that is not covered by the rug?

4. The perimeter of Jillian's rectangular bedroom is 34 feet. The length of her bedroom is 9 feet.

a. Estimate to draw Jillian's bedroom, and label the side lengths.

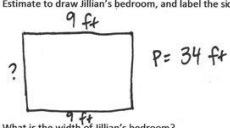

b. What is the width of Jillian's bedroom?

double the  
 $\text{Width} = 34 \text{ ft} - 18 \text{ ft} = 16 \text{ ft}$   
 $\text{Width} = 16 \text{ ft} \div 2 = 8 \text{ ft}$   
 The width of Jillian's bedroom is 8 feet.

c. What is the area of Jillian's bedroom?

$8 \text{ ft} \times 9 \text{ ft} = 72 \text{ sq ft}$   
 The area of Jillian's bedroom is 72 square feet.

d. Jillian has a 4-foot by 6-foot rug in her room. What is the area of the floor that is not covered by the rug?

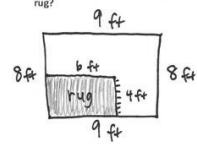

Area of the rug =  $4 \text{ ft} \times 6 \text{ ft} = 24 \text{ sq ft}$   
 $72 \text{ sq ft} - 24 \text{ sq ft} = 48 \text{ sq ft}$   
 The area of the floor that is not covered by the rug is 48 square feet.

This problem asks students to find an unknown side length given one side length and the perimeter. Students need to recall that opposite sides of a rectangle are equal; they might subtract 2 nines from the given perimeter (34 feet) to find the total of 2 widths of the room. Again applying the knowledge that opposite sides of a rectangle are equal, students can divide the total of 2 widths by 2 to find the value of 1 width. In part (d), students first need to find the total area of the rug (24 sq ft) and then subtract it from the total area of Jillian's room (72 sq ft). Encourage students to draw and shade a rectangular rug inside a larger rectangle that represents Jillian's room.

### Student Debrief (10 minutes)

**Lesson Objective:** Solve a variety of word problems involving area and perimeter using all four operations.

The Student Debrief is intended to invite reflection and active processing of the total lesson experience.

Invite students to review their solutions for the Problem Set. They should check work by comparing answers with a partner before going over answers as a class. Look for misconceptions or misunderstandings that can be addressed in the Debrief. Guide students in a conversation to debrief the Problem Set and process the lesson.

Any combination of the questions below may be used to lead the discussion.

- How was it helpful to have each question broken down into several parts?
- Share your drawing of Elijah’s larger rectangle in Problem 2(d). How does the drawing of the rectangle help you figure out the side lengths?
- Explain to a partner how knowing the area and the width helped you find the length of the rectangle in Problem 3.
- How did you know you needed to add the areas of *three* paintings in Problem 3(d)?
- Explain to a partner the steps you took to find the width of the rectangle in Problem 4(b).
- Compare your model with your partner’s model for Problem 4(d). What was the same? What was different?
- Which problem did you find most difficult? Why?

### Exit Ticket (3 minutes)

After the Student Debrief, instruct students to complete the Exit Ticket. A review of their work will help with assessing students’ understanding of the concepts that were presented in today’s lesson and planning more effectively for future lessons. The questions may be read aloud to the students.

Multiply.

$8 \times 1 = \underline{\quad\quad}$      $8 \times 2 = \underline{\quad\quad}$      $8 \times 3 = \underline{\quad\quad}$      $8 \times 4 = \underline{\quad\quad}$

$8 \times 5 = \underline{\quad\quad}$      $8 \times 6 = \underline{\quad\quad}$      $8 \times 7 = \underline{\quad\quad}$      $8 \times 8 = \underline{\quad\quad}$

$8 \times 9 = \underline{\quad\quad}$      $8 \times 10 = \underline{\quad\quad}$      $8 \times 5 = \underline{\quad\quad}$      $8 \times 6 = \underline{\quad\quad}$

$8 \times 5 = \underline{\quad\quad}$      $8 \times 7 = \underline{\quad\quad}$      $8 \times 5 = \underline{\quad\quad}$      $8 \times 8 = \underline{\quad\quad}$

$8 \times 5 = \underline{\quad\quad}$      $8 \times 9 = \underline{\quad\quad}$      $8 \times 5 = \underline{\quad\quad}$      $8 \times 10 = \underline{\quad\quad}$

$8 \times 6 = \underline{\quad\quad}$      $8 \times 5 = \underline{\quad\quad}$      $8 \times 6 = \underline{\quad\quad}$      $8 \times 7 = \underline{\quad\quad}$

$8 \times 6 = \underline{\quad\quad}$      $8 \times 8 = \underline{\quad\quad}$      $8 \times 6 = \underline{\quad\quad}$      $8 \times 9 = \underline{\quad\quad}$

$8 \times 6 = \underline{\quad\quad}$      $8 \times 7 = \underline{\quad\quad}$      $8 \times 6 = \underline{\quad\quad}$      $8 \times 7 = \underline{\quad\quad}$

$8 \times 8 = \underline{\quad\quad}$      $8 \times 7 = \underline{\quad\quad}$      $8 \times 9 = \underline{\quad\quad}$      $8 \times 7 = \underline{\quad\quad}$

$8 \times 8 = \underline{\quad\quad}$      $8 \times 6 = \underline{\quad\quad}$      $8 \times 8 = \underline{\quad\quad}$      $8 \times 7 = \underline{\quad\quad}$

$8 \times 8 = \underline{\quad\quad}$      $8 \times 9 = \underline{\quad\quad}$      $8 \times 9 = \underline{\quad\quad}$      $8 \times 6 = \underline{\quad\quad}$

$8 \times 9 = \underline{\quad\quad}$      $8 \times 7 = \underline{\quad\quad}$      $8 \times 9 = \underline{\quad\quad}$      $8 \times 8 = \underline{\quad\quad}$

$8 \times 9 = \underline{\quad\quad}$      $8 \times 8 = \underline{\quad\quad}$      $8 \times 6 = \underline{\quad\quad}$      $8 \times 9 = \underline{\quad\quad}$

$8 \times 7 = \underline{\quad\quad}$      $8 \times 9 = \underline{\quad\quad}$      $8 \times 6 = \underline{\quad\quad}$      $8 \times 8 = \underline{\quad\quad}$

$8 \times 9 = \underline{\quad\quad}$      $8 \times 7 = \underline{\quad\quad}$      $8 \times 6 = \underline{\quad\quad}$      $8 \times 8 = \underline{\quad\quad}$

multiply by 8 (6–10)

Name \_\_\_\_\_

Date \_\_\_\_\_

1. Gia measures her rectangular garden and finds the width is 9 yards and the length is 7 yards.
  - a. Estimate to draw Gia's garden, and label the side lengths.
  
  
  
  
  
  
  
  
  
  
  - b. What is the area of Gia's garden?
  
  
  
  
  
  
  
  
  
  
  - c. What is the perimeter of Gia's garden?
  
2. Elijah draws a square that has side lengths of 8 centimeters.
  - a. Estimate to draw Elijah's square, and label the side lengths.
  
  
  
  
  
  
  
  
  
  
  - b. What is the area of Elijah's square?
  
  
  
  
  
  
  
  
  
  
  - c. What is the perimeter of Elijah's square?

- d. Elijah connects three of these squares to make one long rectangle. What is the perimeter of this rectangle?
3. The area of Mason's rectangular painting is 72 square inches. The width of the painting is 8 inches.
- a. Estimate to draw Mason's painting, and label the side lengths.
- b. What is the length of the painting?
- c. What is the perimeter of Mason's painting?
- d. Mason's mom hangs the painting on a wall that already has two of Mason's other paintings. The areas of the other paintings are 64 square inches and 81 square inches. What is the total area of the wall that is covered with Mason's paintings?

4. The perimeter of Jillian's rectangular bedroom is 34 feet. The length of her bedroom is 9 feet.
- Estimate to draw Jillian's bedroom, and label the side lengths.
  - What is the width of Jillian's bedroom?
  - What is the area of Jillian's bedroom?
  - Jillian has a 4-foot by 6-foot rug in her room. What is the area of the floor that is not covered by the rug?



Name \_\_\_\_\_

Date \_\_\_\_\_

Jennifer measures her rectangular sandbox and finds the width is 8 feet and the length is 6 feet.

a. Estimate to draw Jennifer's sandbox, and label the side lengths.

b. What is the area of Jennifer's sandbox?

c. What is the perimeter of Jennifer's sandbox?



2. Mr. Briggs puts food for the class party on a rectangular table. The table has a perimeter of 18 feet and a width of 3 feet.
- Estimate to draw the table, and label the side lengths.
  - What is the length of the table?
  - What is the area of the table?
  - Mr. Briggs puts three of these tables together side by side to make 1 long table. What is the area of the long table?

## Lesson 29

**Objective:** Solve a variety of word problems involving area and perimeter using all four operations.

### Suggested Lesson Structure

■ Fluency Practice	(14 minutes)
■ Concept Development	(36 minutes)
■ Student Debrief	(10 minutes)
<b>Total Time</b>	<b>(60 minutes)</b>

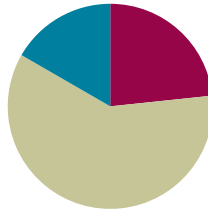

### Fluency Practice (14 minutes)

- Sprint: Multiply or Divide by 8 **3.OA.7** (10 minutes)
- Find the Perimeter **3.MD.8** (4 minutes)

#### Sprint: Multiply or Divide by 8 (10 minutes)

Materials: (S) Multiply or Divide by 8 Sprint

Note: This Sprint builds fluency with multiplication and division facts using units of 8.

#### Find the Perimeter (4 minutes)

Materials: (S) Personal white board

Note: This activity reviews finding perimeter using multiple steps.

- T: (Project the rectangle with a width of 3 m. Inside the rectangle, write Area = 24 square m.) On your personal white board, write the length of this rectangle.
- S: (Write 8 m.)
- T: (Write 8 m on the length of the rectangle. Below the rectangle, write Perimeter = \_\_\_\_.) On your board, write the perimeter of this rectangle. Write a number sentence if you need to.
- S: (Write Perimeter = 22 m.)

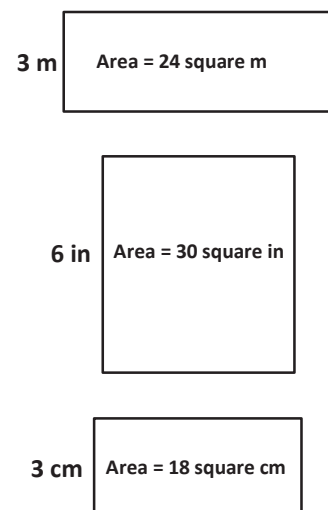

- T: On your board, sketch a rectangle that has an area of 24 square meters but different side lengths than this rectangle.
- S: (Sketch a rectangle with side lengths of 1 m and 24 m, 4 m and 6 m, or 2 m and 12 m.)
- T: (Write Perimeter = \_\_\_\_.) Calculate the perimeter of the new rectangle.
- S: (Write Perimeter = 50 m, 20 m, or 28 m.)

Repeat the process with the other rectangles.

### Concept Development (36 minutes)

Materials: (S) Problem Set

Note: Save today's Problem Set for use in Lesson 30.

MP.1

This is a problem-solving lesson in which students work in pairs or independently to solve the four problems on the Problem Set. Consider using the three-step approach outlined in Lesson 23 to guide them through solving (the basic steps are shown below). Specific information about each problem follows and can be used to further facilitate conversation.

Three-Step Approach to Solving:

1. Read and model (if applicable).
2. Write an equation, calculate to solve, and write a statement.
3. Assess the solution for reasonableness.

**Problem 1: Kyle puts two rectangles together to make the L-shaped figure below. He measures some of the side lengths and records them as shown.**

- a. Find the perimeter of Kyle's shape.
- b. Find the area of Kyle's shape.
- c. Kyle makes two copies of the L-shaped figure to create the rectangle shown below. Find the perimeter of the rectangle.

In part (a), students apply knowledge of rectangles (opposite sides have equal lengths) to find the information necessary to solve. In part (b), students might estimate to draw lines showing the two distinct rectangles with which Kyle started the problem. From there they can multiply to find the area of each one and then add to find the total.



#### NOTES ON MULTIPLE MEANS OF REPRESENTATION:

For the composite figure in Problem 1 (and others like it), consider teaching students how to draw brackets to clearly match each side length with its measure.

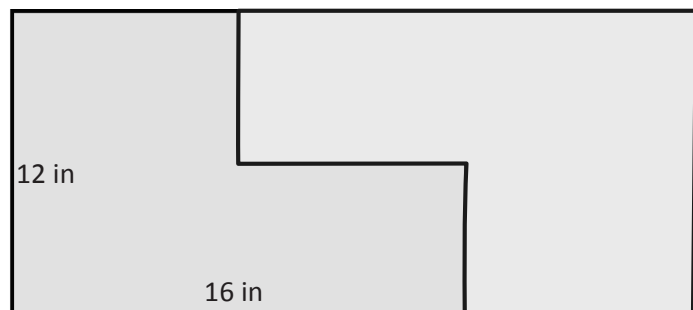
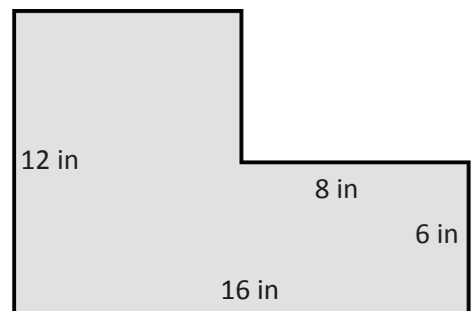

Students need to use the break apart and distribute strategy to find the area of the larger rectangle. In part (c), students might start by labeling the sides of the rectangle that are not yet labeled, remembering that it is only the outside lengths that are now important. They need to use addition (16 in + 8 in) to find the total length of the top and bottom or see that the part of each L that belongs to the perimeter is 36 inches and then double it to 72 inches.

**Problem 2: Jeremiah and Hayley use a piece of rope to mark a square space for their booth at the science fair. The area of their space is 49 square feet. What is the length of the rope that Jeremiah and Hayley use if they leave a 3-foot opening so they can get in and out of the space?**

Students might begin by finding the side lengths of the square space, remembering that squares have equal side lengths. They might think about which factor multiplied by itself equals 49. After that, they can estimate to draw the square space that Jeremiah and Hayley need. Now that they have the side lengths of the space figured out (7 feet), students have to add to their drawings to account for the 3-foot opening on one side. This brings the amount of rope needed on that side from 7 feet down to 4 feet. Finally, students might add or multiply to find the amount of rope needed. (7 + 7 + 7 + 4 or 3 × 7 + 4.) They can also find the total perimeter and subtract three. (4 × 7 – 3.)

**Problem 3: Vivienne draws four identical rectangles as shown below to make a new, larger rectangle. The perimeter of one of the small rectangles is 18 centimeters, and the width is 6 centimeters. What is the perimeter of the new, larger rectangle?**

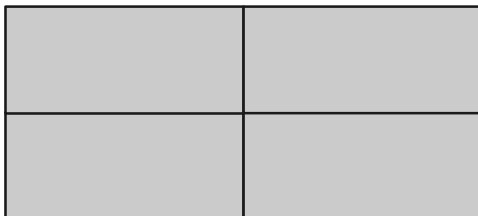

Name Gina Date \_\_\_\_\_

1. Kyle puts two rectangles together to make the L-shaped figure below. He measures some of the side lengths and records them as shown.

$A = 12 \text{ in} \times 8 \text{ in}$   
 $= 10 \text{ in} \times 2 \text{ in} + (2 \text{ in} \times 8 \text{ in})$   
 $= 80 \text{ sq in} + 16 \text{ sq in}$   
 $= 96 \text{ sq in}$

$A = 8 \text{ in} \times 6 \text{ in} = 48 \text{ sq in}$

a. Find the perimeter of Kyle's shape.  
 $P = 12 \text{ in} + 8 \text{ in} + 6 \text{ in} + 8 \text{ in} + 6 \text{ in} + 16 \text{ in} = 56 \text{ in}$   
 The perimeter of Kyle's shape is 56 inches.

b. Find the area of Kyle's shape.  
 $A = 96 \text{ sq in} + 48 \text{ sq in}$   
 $= 100 \text{ sq in} + 44 \text{ sq in} = 144 \text{ sq in}$   
 The area of Kyle's shape is 144 square inches.

c. Kyle makes two copies of the L-shaped figure to create the rectangle shown below. Find the perimeter of the rectangle.

$P = 12 \text{ in} + 12 \text{ in} + 24 \text{ in} + 24 \text{ in}$   
 $= 72 \text{ in}$   
 The perimeter of the rectangle is 72 inches.

2. Jeremiah and Hayley use a piece of rope to mark a square space for their booth at the science fair. The area of their space is 49 square feet. What is the length of the rope that Jeremiah and Hayley use if they leave a 3-foot opening so they can get in and out of the space?

$P = 7 \text{ ft} + 7 \text{ ft} + 7 \text{ ft} + 4 \text{ ft}$   
 $= 21 \text{ ft} + 4 \text{ ft}$   
 $= 25 \text{ ft}$   
 The length of the rope is 25 feet.

3. Vivienne draws four identical rectangles as shown below to make a new, larger rectangle. The perimeter of one of the small rectangles is 18 centimeters and the width is 6 centimeters. What is the perimeter of the new, larger rectangle?

$18 \text{ cm} - 12 \text{ cm} = 6 \text{ cm}$   
 $6 \text{ cm} \div 2 = 3 \text{ cm}$   
 Perimeter of larger rectangle =  $6 \text{ cm} + 12 \text{ cm} + 6 \text{ cm} + 12 \text{ cm}$   
 $= 36 \text{ cm}$   
 The perimeter of the new, larger rectangle is 36 centimeters.

4. A jogging path around the outside edges of a rectangular playground measures 48 yards by 52 yards. Maya runs  $3\frac{1}{2}$  laps on the jogging path. What is the total number of yards Maya runs?

$P = 48 \text{ yd} + 52 \text{ yd} + 48 \text{ yd} + 52 \text{ yd}$   
 $= 200 \text{ yd}$   
 Half of 200 yd = 100 yd  
 $P \text{ of } 3\frac{1}{2} \text{ laps} = (3 \times 200 \text{ yd}) + 100 \text{ yd}$   
 $= 600 \text{ yd} + 100 \text{ yd}$   
 $= 700 \text{ yd}$   
 Maya runs 700 yards.

Knowing that each smaller rectangle has a width of 6 centimeters and a perimeter of 18 centimeters, students may solve by dividing the perimeter by 2 ( $18 \text{ cm} \div 2 = 9 \text{ cm}$ ) and then finding the missing side length with the equation ( $6 \text{ cm} + n \text{ cm} = 9 \text{ cm}$ ). Once they find that measurement to be 3 centimeters, they likely add to find the total length of each set of sides for the large rectangle ( $3 \text{ cm} + 3 \text{ cm}$  and  $6 \text{ cm} + 6 \text{ cm}$ ). After that, they can add to find the total perimeter.

Students may initially wonder *which* sides of the small rectangles—the long or short sides—measure 6 centimeters. However, once they find the unknown side length to be 3 centimeters, they can reason that the long sides must measure 6 centimeters and the short sides must measure 3 centimeters.

**Problem 4: A jogging path around the outside edges of a rectangular playground measures 48 yards by 52 yards. Maya runs  $3\frac{1}{2}$  laps on the jogging path. What is the total number of yards Maya runs?**

Students can begin by estimating to draw and label the rectangular park. After that, they find how many total yards are in 1 lap around the track (200 yards). Once they know the perimeter of the park, they can reason to figure out that half of a lap is half of 200 yards, or 100 yards. Students might use a combination of multiplication and addition ( $(3 \times 200) + 100$ ) or addition ( $200 + 200 + 200 + 100$ ) to solve. Either solution path brings them to the final answer: Maya runs 700 yards.



#### NOTES ON MULTIPLE MEANS OF ACTION AND EXPRESSION:

To provide scaffolds for students working below grade level, break the word problems into smaller steps as in Lesson 29. For Problem 3, for example, ask, “What is the length of one of the small rectangles? What is the perimeter of one of the small rectangles? What is the perimeter of the new, larger rectangle?”

### Student Debrief (10 minutes)

**Lesson Objective:** Solve a variety of word problems involving area and perimeter using all four operations.

The Student Debrief is intended to invite reflection and active processing of the total lesson experience.

Invite students to review their solutions for the Problem Set. They should check work by comparing answers with a partner before going over answers as a class. Look for misconceptions or misunderstandings that can be addressed in the Debrief. Guide students in a conversation to debrief the Problem Set and process the lesson.

Any combination of the questions below may be used to lead the discussion.

- How were you able to figure out the unknown side lengths in Problem 1(a)?
- Problem 1(c) had a rectangle formed from combining two copies of the shape from Problem 1 (a) and (b). Why was the answer in Problem 1(c) not double the answer of Problem 1(a)?
- How did you figure out the side lengths for the smaller rectangles in Problem 3?
- Describe the steps you took to solve Problem 4.
- How were today’s problems similar to yesterday’s problems? How were they different?
- What complexity did you notice in each problem of the Problem Set today?

**Exit Ticket (3 minutes)**

After the Student Debrief, instruct students to complete the Exit Ticket. A review of their work will help with assessing students' understanding of the concepts that were presented in today's lesson and planning more effectively for future lessons. The questions may be read aloud to the students.



## A

Number Correct: \_\_\_\_\_

Multiply or Divide by 8

1.	$2 \times 8 =$	
2.	$3 \times 8 =$	
3.	$4 \times 8 =$	
4.	$5 \times 8 =$	
5.	$1 \times 8 =$	
6.	$16 \div 8 =$	
7.	$24 \div 8 =$	
8.	$40 \div 8 =$	
9.	$8 \div 8 =$	
10.	$32 \div 8 =$	
11.	$6 \times 8 =$	
12.	$7 \times 8 =$	
13.	$8 \times 8 =$	
14.	$9 \times 8 =$	
15.	$10 \times 8 =$	
16.	$64 \div 8 =$	
17.	$56 \div 8 =$	
18.	$72 \div 8 =$	
19.	$48 \div 8 =$	
20.	$80 \div 8 =$	
21.	$\underline{\quad} \times 8 = 40$	
22.	$\underline{\quad} \times 8 = 8$	

23.	$\underline{\quad} \times 8 = 80$	
24.	$\underline{\quad} \times 8 = 16$	
25.	$\underline{\quad} \times 8 = 24$	
26.	$80 \div 8 =$	
27.	$40 \div 8 =$	
28.	$8 \div 8 =$	
29.	$16 \div 8 =$	
30.	$24 \div 8 =$	
31.	$\underline{\quad} \times 8 = 48$	
32.	$\underline{\quad} \times 8 = 56$	
33.	$\underline{\quad} \times 8 = 72$	
34.	$\underline{\quad} \times 8 = 64$	
35.	$56 \div 8 =$	
36.	$72 \div 8 =$	
37.	$48 \div 8 =$	
38.	$64 \div 8 =$	
39.	$11 \times 8 =$	
40.	$88 \div 8 =$	
41.	$12 \times 8 =$	
42.	$96 \div 8 =$	
43.	$14 \times 8 =$	
44.	$112 \div 8 =$	

## B

Number Correct: \_\_\_\_\_

Improvement: \_\_\_\_\_

Multiply or Divide by 8

1.	$1 \times 8 =$	
2.	$2 \times 8 =$	
3.	$3 \times 8 =$	
4.	$4 \times 8 =$	
5.	$5 \times 8 =$	
6.	$24 \div 8 =$	
7.	$16 \div 8 =$	
8.	$32 \div 8 =$	
9.	$8 \div 8 =$	
10.	$40 \div 8 =$	
11.	$10 \times 8 =$	
12.	$6 \times 8 =$	
13.	$7 \times 8 =$	
14.	$8 \times 8 =$	
15.	$9 \times 8 =$	
16.	$56 \div 8 =$	
17.	$8 \div 8 =$	
18.	$64 \div 8 =$	
19.	$80 \div 8 =$	
20.	$72 \div 8 =$	
21.	$\_\_\_ \times 8 = 8$	
22.	$\_\_\_ \times 8 = 40$	

23.	$\_\_\_ \times 8 = 16$	
24.	$\_\_\_ \times 8 = 80$	
25.	$\_\_\_ \times 8 = 24$	
26.	$16 \div 8 =$	
27.	$8 \div 8 =$	
28.	$80 \div 8 =$	
29.	$40 \div 8 =$	
30.	$24 \div 8 =$	
31.	$\_\_\_ \times 8 = 24$	
32.	$\_\_\_ \times 8 = 32$	
33.	$\_\_\_ \times 8 = 72$	
34.	$\_\_\_ \times 8 = 56$	
35.	$64 \div 8 =$	
36.	$72 \div 8 =$	
37.	$48 \div 8 =$	
38.	$56 \div 8 =$	
39.	$11 \times 8 =$	
40.	$88 \div 8 =$	
41.	$12 \times 8 =$	
42.	$96 \div 8 =$	
43.	$13 \times 8 =$	
44.	$104 \div 8 =$	

Name \_\_\_\_\_

Date \_\_\_\_\_

1. Kyle puts two rectangles together to make the L-shaped figure below. He measures some of the side lengths and records them as shown.

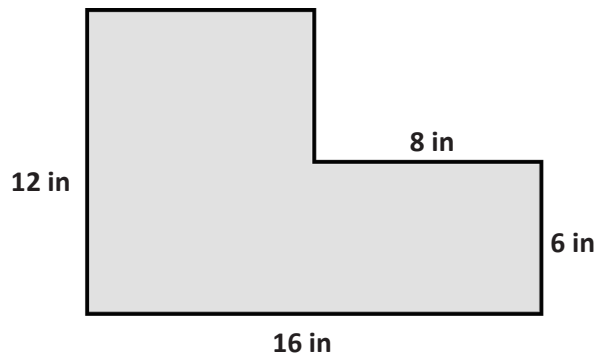

- a. Find the perimeter of Kyle's shape.
- b. Find the area of Kyle's shape.
- c. Kyle makes two copies of the L-shaped figure to create the rectangle shown below. Find the perimeter of the rectangle.

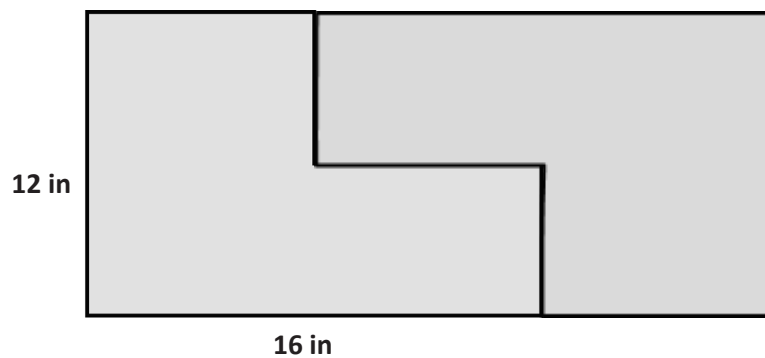

2. Jeremiah and Hayley use a piece of rope to mark a square space for their booth at the science fair. The area of their space is 49 square feet. What is the length of the rope that Jeremiah and Hayley use if they leave a 3-foot opening so they can get in and out of the space?
3. Vivienne draws four identical rectangles as shown below to make a new, larger rectangle. The perimeter of one of the small rectangles is 18 centimeters, and the width is 6 centimeters. What is the perimeter of the new, larger rectangle?

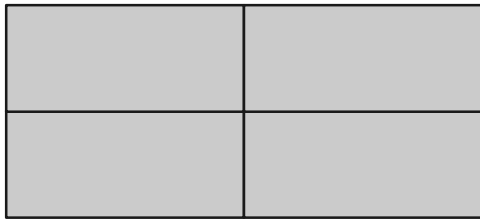

4. A jogging path around the outside edges of a rectangular playground measures 48 yards by 52 yards. Maya runs  $3\frac{1}{2}$  laps on the jogging path. What is the total number of yards Maya runs?

Name \_\_\_\_\_

Date \_\_\_\_\_

Jeannette draws four identical squares as shown below to make a new, larger square. The length of one of the small square sides is 8 centimeters. What is the perimeter of the new, larger square?

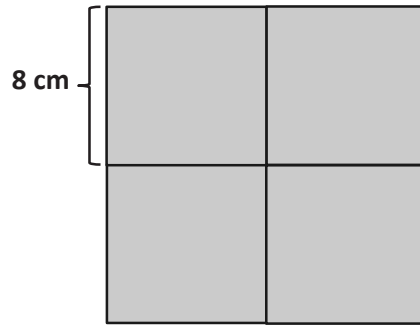

Name \_\_\_\_\_

Date \_\_\_\_\_

1. Katherine puts two squares together to make the rectangle below. The side lengths of the squares measure 8 inches.



- a. What is the perimeter of the rectangle Katherine made with her 2 squares?
- b. What is the area of Katherine's rectangle?
- c. Katherine decides to draw another rectangle of the same size. What is the area of the new, larger rectangle?



2. Daryl draws 6 equal-sized rectangles as shown below to make a new, larger rectangle. The area of one of the small rectangles is 12 square centimeters, and the width of the small rectangle is 4 centimeters.

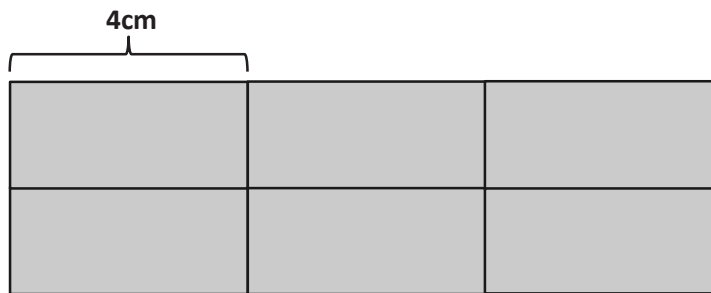

- a. What is the perimeter of Daryl's new rectangle?
- b. What is the area of Daryl's new rectangle?
3. The recreation center soccer field measures 35 yards by 65 yards. Chris dribbles the soccer ball around the perimeter of the field 4 times. What is the total number of yards Chris dribbles the ball?

## Lesson 30

Objective: Share and critique peer strategies for problem solving.

### Suggested Lesson Structure

■ Fluency Practice	(12 minutes)
■ Concept Development	(38 minutes)
■ Student Debrief	(10 minutes)
<b>Total Time</b>	<b>(60 minutes)</b>

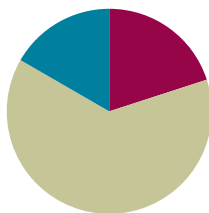

### Fluency Practice (12 minutes)

- Multiply by 9 **3.OA.7** (8 minutes)
- Multiply and Divide **3.OA.7** (4 minutes)

### Multiply by 9 (8 minutes)

Materials: (S) Multiply by 9 (6–10) Pattern Sheet

Note: This activity builds fluency with multiplication facts using units of 9. It works toward students knowing from memory all products of two one-digit numbers. See Lesson 1 for the directions for administration of a Multiply-By Pattern Sheet.

T: (Write  $7 \times 9 = \underline{\quad}$ .) Let's skip-count up by nines. I'll raise a finger for each nine. (Raise a finger for each number to track the count.)

S: 9, 18, 27, 36, 45, 54, 63.

T: Let's skip-count up by nines starting at 45. Why is 45 a good place to start?

S: It is a fact we already know, so we can use it to figure out a fact we do not know.

T: (Track with fingers as students say the numbers.)

S: 45 (5 fingers), 54 (6 fingers), 63 (7 fingers).

T: Let's see how we can skip-count down to find the answer, too. Start at 90 with 10 fingers, 1 for each nine. (Count down with fingers as students say the numbers.)

S: 90 (10 fingers), 81 (9 fingers), 72 (8 fingers), 63 (7 fingers).

Continue with the following possible sequence:  $9 \times 9$ ,  $6 \times 9$ , and  $8 \times 9$ .

T: (Distribute the Multiply by 9 Pattern Sheet.) Let's practice multiplying by 9. Be sure to work left to right across the page.



**Multiply and Divide (4 minutes)**

Note: This activity focuses on student mastery of all products of two one-digit numbers.

T: (Write  $2 \times 2 = \underline{\quad}$ .) Say the multiplication sentence.

S:  $2 \times 2 = 4$ .

Continue with the following possible sequence:  $3 \times 3$ ,  $4 \times 4$ , and  $5 \times 5$ .

T: (Write  $3 \times 2 = \underline{\quad}$ .) Say the multiplication sentence.

S:  $3 \times 2 = 6$ .

T: Flip it.

S:  $2 \times 3 = 6$ .

Continue with the following possible sequence:  $4 \times 2$ ,  $5 \times 3$ , and  $4 \times 3$ .

T: (Write  $4 \div 2 = \underline{\quad}$ .) Say the division sentence.

S:  $4 \div 2 = 2$ .

Continue with the following possible sequence:  $15 \div 5$ ,  $9 \div 3$ , and  $24 \div 4$ .

**Concept Development (38 minutes)**

Materials: (T) Student work sample images (Template), timer  
(S) Problem Sets from Lessons 28, 29, and 30,  
personal white board

**Part 1: Analyze sample student work for accuracy and efficiency.**

T: Read Problem 3 from yesterday's Problem Set.

S: (Read: Jeremiah and Hayley use a piece of rope to mark a square space for their booth at the science fair. The area of their space is 49 square feet. What is the length of the rope that Jeremiah and Hayley use if they leave a 3-foot opening so they can get in and out of the space?)

T: (Project Student A's work from the Template.) Let's look at and discuss some possible solutions for this problem. Talk to your partner. What did Student A do to solve?

**NOTES ON  
MULTIPLE MEANS  
OF REPRESENTATION:**

Provide sentence starters to help English language learners confidently articulate what Student A did to solve:

- Student A drew a        and labeled...
- He wrote the equation       , which makes sense because ...
- He found the length of the rope by...
- He subtracted        because...

**Student A**

- S: He found the side lengths of the square. Then, he figured out the perimeter of the square and subtracted the 3-foot opening to find the length of the rope.
- T: Other than getting the right answer, what did Student A do well?
- S: He drew a picture of the square and labeled the area and the side lengths. → He multiplied 4 sides times 7 centimeters to find the perimeter. → He drew a tape diagram to show why he subtracted in the last step. → He used a letter to represent the unknown.

Facilitate a discussion in which students analyze this work more closely. Use any combination of the following questions to guide the conversation.

- Was the drawing helpful? What makes it helpful or unhelpful?
  - Did Student A represent all the important information in his drawing? Why or why not?
  - Was this drawing the best one to use? Why or why not?
  - Can you retell the story using only the drawing and labels? Explain.
  - How did he organize the information?
- T: What suggestion would you make to Student A to improve his work?
- S: He does not need the addition number sentence for perimeter since he has the multiplication number sentence. → In the second step of the problem, it is not really clear what he is solving for. Maybe instead of using the letter P, he could write *perimeter* so anyone who looks at his work knows he is finding the perimeter. → He could draw another picture to show the square with the 3-foot opening in it. Then, he could just add the side lengths, and he would not have to show the third step of subtracting.

Repeat the process of analyzing using the two samples from the Template below. Modify these or create others as appropriate for the class. Select samples that are likely to stimulate discussion beneficial to student needs.

**Student B**

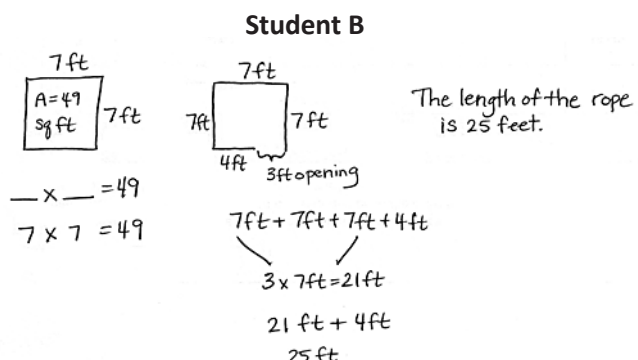

**Student C**

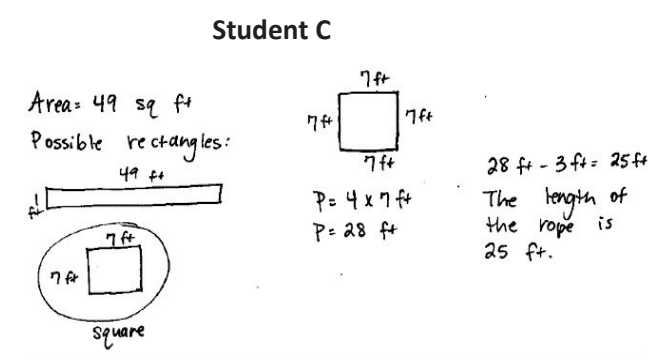

Conclude the analysis of the sample student work for this problem by discussing the following questions:

- Can you think of a quicker way to solve this problem? Why or why not?
- Would you have chosen any of these ways to solve this problem? Why or why not?

**Part 2: Analyze peer work for accuracy and efficiency.**

Note: Students should have enough copies of the Problem Set to complete a critique for each member of their group, or they can record their thoughts in their math journals.

Students work in groups of four to share solutions and critique their classmates' work. Students take turns presenting their solutions to a problem from the Lesson 28 or 29 Problem Sets. Today's Problem Set is a critiquing tool that group members can use as a guide for analysis and a place where they can record their thoughts at each step of the way. When a student finishes presenting, the other group members take a few minutes to ask the presenter clarifying questions. They might use questions similar to those given for discussion facilitation in Part 1. Students continue in this manner until each group member has presented at least one solution for the group to analyze.

**MP.3**

Prepare students:

- Model how students should present their work to their groups.
- List some of the clarifying questions that group members can choose to ask the presenter.
- Show a completed Problem Set (critiquing tool) to establish expectations for the group members who are critiquing their classmate's solution.
- Remind students to show their appreciation to classmates, both for sharing their work and for providing feedback about their work.
- Inform students that a timer will be set to let them know when they should transition to a new presenter, if appropriate for the class.
- Provide each group with a talking tool (e.g., a craft stick) to establish a protocol for only one student in the group to talk while the others listen, if appropriate for the class. Model using and then passing the tool to other group members to talk.

**NOTES ON  
MULTIPLE MEANS  
OF ENGAGEMENT:**

Student presenters may use translators, interpreters, or sentence frames to present and respond to feedback. Models shared may include concrete manipulatives, adaptive materials, or technology. If timing is a consideration, prepare presenters beforehand.

**Student Debrief (10 minutes)**

**Lesson Objective:** Share and critique peer strategies for problem solving.

The Student Debrief is intended to invite reflection and active processing of the total lesson experience.

Invite students to review their solutions for the Problem Set. They should check work by comparing answers with a partner before going over answers as a class. Look for misconceptions or misunderstandings that can be addressed in the Debrief. Guide students in a conversation to debrief the Problem Set and process the lesson.

Any combination of the questions below may be used to lead the discussion.

- How did today's Problem Set or critiquing tool help you analyze your classmates' work?
- How does having your work critiqued by your classmates improve your problem-solving skills?

- How does critiquing your classmates' work improve your problem-solving skills?
- What was difficult about today's group activity? Why was it difficult?
- What strategies did you see in your classmates' work that you might try in future problems?

### Exit Ticket (3 minutes)

After the Student Debrief, instruct students to complete the Exit Ticket. A review of their work will help with assessing students' understanding of the concepts that were presented in today's lesson and planning more effectively for future lessons. The questions may be read aloud to the students.

Name: <u>Gina</u>		Date: _____	
Use this form to critique your classmate's problem-solving work.			
Classmate:	<u>Charlotte</u>	Problem number:	<u>L29 #4</u>
Strategies my classmate used:	<ul style="list-style-type: none"> <li>• Drew a picture of a rectangle and labeled side lengths.</li> <li>• Added to find perimeter.</li> <li>• Used a tape diagram to find total of <math>3\frac{1}{2}</math> perimeters.</li> </ul>		
Things my classmate did well:	<ul style="list-style-type: none"> <li>• Used all steps in RDW.</li> <li>• Realized that <math>52+48=100</math>, so the perimeter is <math>2 \times 100 = 200</math>.</li> <li>• Drew and labeled a tape diagram to show thinking for the last step.</li> </ul>		
Suggestions for improvement:	<ul style="list-style-type: none"> <li>• Use a letter to show the unknown in the last step.</li> <li>• Include units in all steps.</li> </ul>		
Strategies I would like to try based on my classmate's work:	<ul style="list-style-type: none"> <li>• Thinking about numbers, like <math>52+48=100</math>, so I can use mental math, or do less work.</li> </ul>		

Multiply.

$9 \times 1 = \underline{\quad\quad\quad}$      $9 \times 2 = \underline{\quad\quad\quad}$      $9 \times 3 = \underline{\quad\quad\quad}$      $9 \times 4 = \underline{\quad\quad\quad}$

$9 \times 5 = \underline{\quad\quad\quad}$      $9 \times 6 = \underline{\quad\quad\quad}$      $9 \times 7 = \underline{\quad\quad\quad}$      $9 \times 8 = \underline{\quad\quad\quad}$

$9 \times 9 = \underline{\quad\quad\quad}$      $9 \times 10 = \underline{\quad\quad\quad}$      $9 \times 5 = \underline{\quad\quad\quad}$      $9 \times 6 = \underline{\quad\quad\quad}$

$9 \times 5 = \underline{\quad\quad\quad}$      $9 \times 7 = \underline{\quad\quad\quad}$      $9 \times 5 = \underline{\quad\quad\quad}$      $9 \times 8 = \underline{\quad\quad\quad}$

$9 \times 5 = \underline{\quad\quad\quad}$      $9 \times 9 = \underline{\quad\quad\quad}$      $9 \times 5 = \underline{\quad\quad\quad}$      $9 \times 10 = \underline{\quad\quad\quad}$

$9 \times 6 = \underline{\quad\quad\quad}$      $9 \times 5 = \underline{\quad\quad\quad}$      $9 \times 6 = \underline{\quad\quad\quad}$      $9 \times 7 = \underline{\quad\quad\quad}$

$9 \times 6 = \underline{\quad\quad\quad}$      $9 \times 8 = \underline{\quad\quad\quad}$      $9 \times 6 = \underline{\quad\quad\quad}$      $9 \times 9 = \underline{\quad\quad\quad}$

$9 \times 6 = \underline{\quad\quad\quad}$      $9 \times 7 = \underline{\quad\quad\quad}$      $9 \times 6 = \underline{\quad\quad\quad}$      $9 \times 7 = \underline{\quad\quad\quad}$

$9 \times 8 = \underline{\quad\quad\quad}$      $9 \times 7 = \underline{\quad\quad\quad}$      $9 \times 9 = \underline{\quad\quad\quad}$      $9 \times 7 = \underline{\quad\quad\quad}$

$9 \times 8 = \underline{\quad\quad\quad}$      $9 \times 6 = \underline{\quad\quad\quad}$      $9 \times 8 = \underline{\quad\quad\quad}$      $9 \times 7 = \underline{\quad\quad\quad}$

$9 \times 8 = \underline{\quad\quad\quad}$      $9 \times 9 = \underline{\quad\quad\quad}$      $9 \times 9 = \underline{\quad\quad\quad}$      $9 \times 6 = \underline{\quad\quad\quad}$

$9 \times 9 = \underline{\quad\quad\quad}$      $9 \times 7 = \underline{\quad\quad\quad}$      $9 \times 9 = \underline{\quad\quad\quad}$      $9 \times 8 = \underline{\quad\quad\quad}$

$9 \times 9 = \underline{\quad\quad\quad}$      $9 \times 8 = \underline{\quad\quad\quad}$      $9 \times 6 = \underline{\quad\quad\quad}$      $9 \times 9 = \underline{\quad\quad\quad}$

$9 \times 7 = \underline{\quad\quad\quad}$      $9 \times 9 = \underline{\quad\quad\quad}$      $9 \times 6 = \underline{\quad\quad\quad}$      $9 \times 8 = \underline{\quad\quad\quad}$

$9 \times 9 = \underline{\quad\quad\quad}$      $9 \times 7 = \underline{\quad\quad\quad}$      $9 \times 6 = \underline{\quad\quad\quad}$      $9 \times 8 = \underline{\quad\quad\quad}$

multiply by 9 (6–10)

Name \_\_\_\_\_

Date \_\_\_\_\_

Use this form to critique your classmate's problem-solving work.

Classmate:		Problem Number:	
Strategies My Classmate Used:			
Things My Classmate Did Well:			
Suggestions for Improvement:			
Strategies I Would Like to Try Based on My Classmate's Work:			

Name \_\_\_\_\_

Date \_\_\_\_\_

Jayden solves the problem as shown below.

The recreation center soccer field measures 35 yards by 65 yards. Chris dribbles the soccer ball around the field 4 times. What is the total number of yards Chris dribbles the ball?

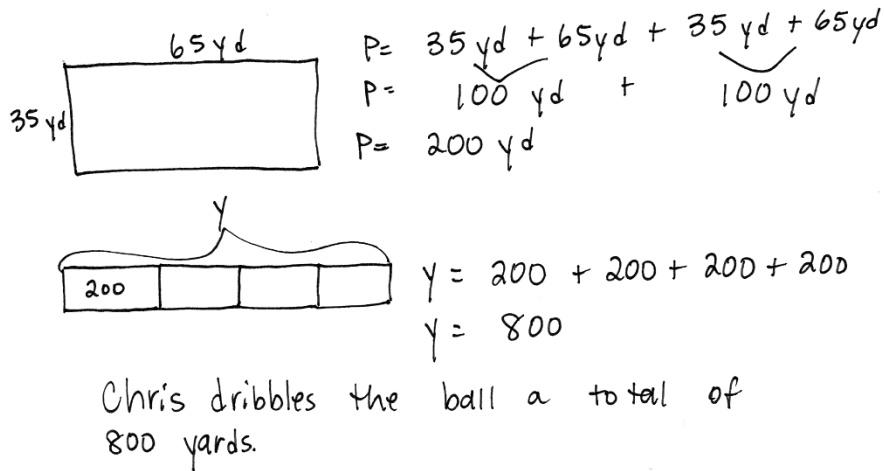

$P = 35 \text{ yd} + 65 \text{ yd} + 35 \text{ yd} + 65 \text{ yd}$   
 $P = 100 \text{ yd} + 100 \text{ yd}$   
 $P = 200 \text{ yd}$

$y = 200 + 200 + 200 + 200$   
 $y = 800$

Chris dribbles the ball a total of 800 yards.

1. What strategies did Jayden use to solve this problem?

2. What did Jayden do well?

Name \_\_\_\_\_

Date \_\_\_\_\_

Use this form to critique Student A's problem-solving work on the next page.

Student:	Student A	Problem Number:	
Strategies Student A Used:			
Things Student A Did Well:			
Suggestions for Improvement:			
Strategies I Would Like to Try Based on Student A's Work:			



Name \_\_\_\_\_ **STUDENT A** \_\_\_\_\_

Date \_\_\_\_\_

1. Katherine puts 2 squares together to make the rectangle below. The side lengths of the squares measure 8 inches.



- a. What is the perimeter of Katherine's rectangle?

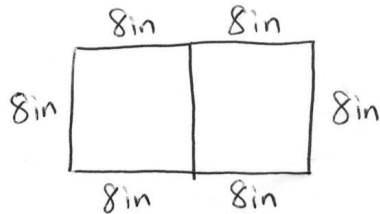

$$P = 6 \times 8 \text{ in}$$

$$P = 48 \text{ in}$$

The perimeter is  
48 inches.

- b. What is the area of Katherine's rectangle?

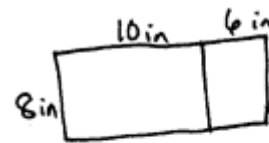

$$A = (8 \times 10) + (8 \times 6)$$

$$A = 80 + 48$$

$$A = 128$$

The area is 128 sq in.

- c. Katherine draws 2 of the rectangles in Problem 1 side by side. Her new, larger rectangle is shown below. What is the area of the new, larger rectangle?

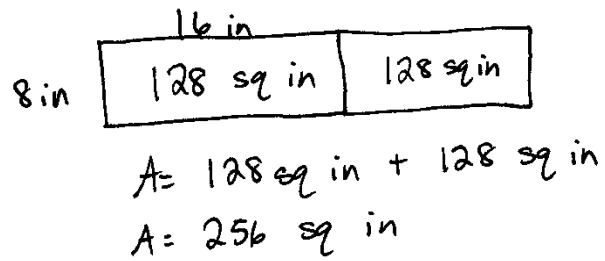

The area of the new rectangle is 256 sq in.

Student A

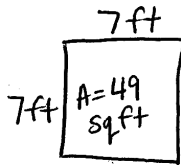

$$7 \times 7 = 49$$

$$P = 7 \text{ ft} + 7 \text{ ft} + 7 \text{ ft} + 7 \text{ ft}$$

$$P = 4 \times 7 \text{ ft}$$

$$P = 28 \text{ ft}$$

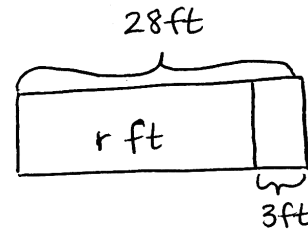

$$r = 28 - 3$$

$$r = 25$$

The total length of the rope is 25 feet.

Student B

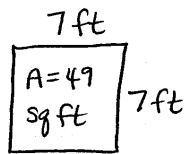

$$\_ \times \_ = 49$$

$$7 \times 7 = 49$$

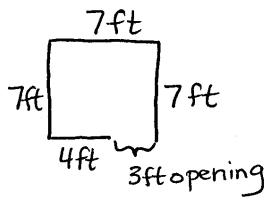

The length of the rope is 25 feet.

$$7 \text{ ft} + 7 \text{ ft} + 7 \text{ ft} + 4 \text{ ft}$$

$$3 \times 7 \text{ ft} = 21 \text{ ft}$$

$$21 \text{ ft} + 4 \text{ ft}$$

$$25 \text{ ft}$$

Student C

Area = 49 sq ft  
Possible rectangles:

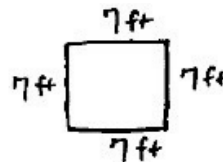
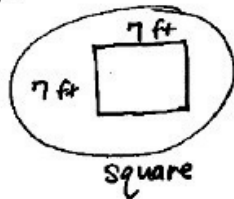
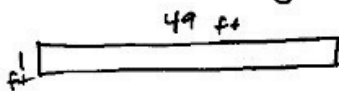

$$P = 4 \times 7 \text{ ft}$$

$$P = 28 \text{ ft}$$

$$28 \text{ ft} - 3 \text{ ft} = 25 \text{ ft}$$

The length of the rope is 25 ft.

student work sample images



2. Each shape has a missing side length labeled with a letter. The perimeter of the shape is labeled inside. Find the unknown side length for each shape.

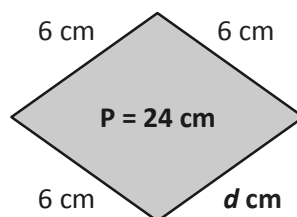
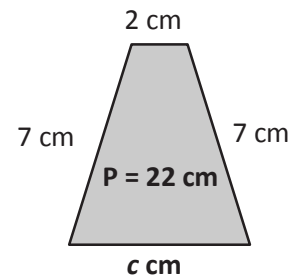
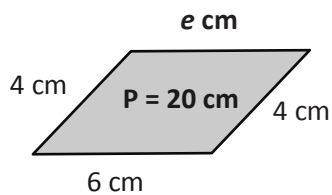
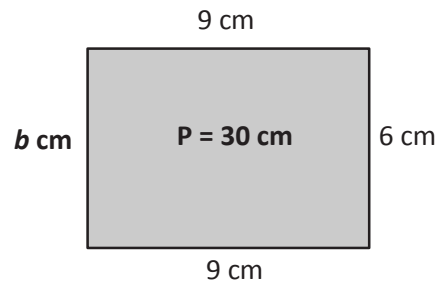
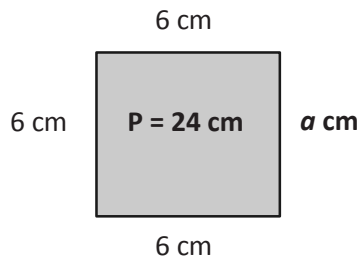

3. Suppose each  is 1 square centimeter.

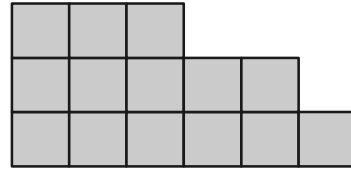
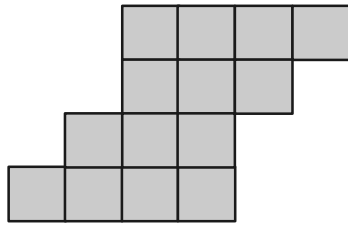

- a. Find the area and perimeter of each shape.

- b. John says, "If two shapes have the same area, they must also have the same perimeter." Is John correct? Use your answer from part (a) above to explain why or why not.

4. Mr. Jackson's class finds all possible perimeters for a rectangle composed of 36 centimeter tiles. The chart below shows how many students found each rectangle.

Perimeter	Number of Students
24 cm	6
26 cm	9
30 cm	5
40 cm	7
74 cm	4

- a. Check the students' work. Did they find all the possible perimeters? How do you know?

- b. Use the chart. Estimate to construct a line plot of how many students found each perimeter.

**Number of Students Who Found Each Perimeter**

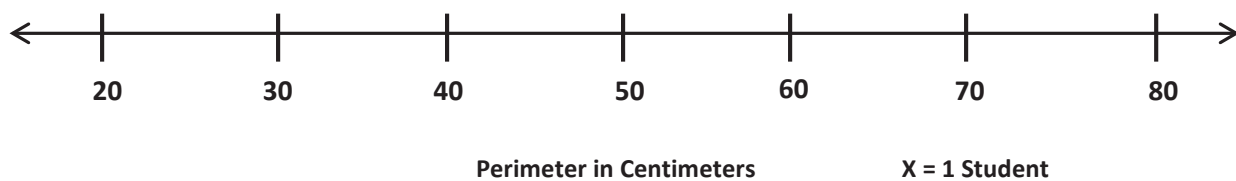

5. The square to the right has an area of 16 square centimeters.
- a. What is the length of each side? Explain how you know.

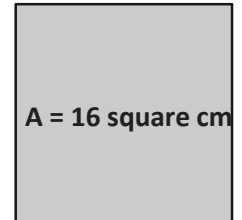

- b. Draw copies of the square above to make a figure with a perimeter of 32 centimeters.
- c. Write a number sentence to show that your figure has the correct perimeter of 32 centimeters.



**End-of-Module Assessment Task  
Standards Addressed**

Topics A–E

**Solve problems involving the four operations, and identify and explain patterns in arithmetic.**

- 3.OA.8** Solve two-step word problems using the four operations. Represent these problems using equations with a letter standing for the unknown quantity. Assess the reasonableness of answers using mental computation and estimation strategies including rounding. (This standard is limited to problems posed with whole numbers and having whole number answers; students should know how to perform operations in the conventional order when there are no parentheses to specify a particular order [Order of Operations].)

**Represent and interpret data.**

- 3.MD.4** Generate measurement data by measuring lengths using rulers marked with halves and fourths of an inch. Show the data by making a line plot, where the horizontal scale is marked off in appropriate units—whole numbers, halves, or quarters.

**Geometric measurement: recognize perimeter as an attribute of plane figures and distinguish between linear and area measures.**

- 3.MD.8** Solve real world and mathematical problems involving perimeters of polygons, including finding the perimeter given the side lengths, finding an unknown side length, and exhibiting rectangles with the same perimeter and different areas or with the same area and different perimeters.

**Reason with shapes and their attributes.**

- 3.G.1** Understand that shapes in different categories (e.g., rhombuses, rectangles, and others) may share attributes (e.g., having four sides), and that the shared attributes can define a larger category (e.g., quadrilaterals). Recognize rhombuses, rectangles, and squares as examples of quadrilaterals, and draw examples of quadrilaterals that do not belong to any of these subcategories.

## Evaluating Student Learning Outcomes

A Progression Toward Mastery is provided to describe steps that illuminate the gradually increasing understandings that students develop *on their way to proficiency*. In this chart, this progress is presented from left (Step 1) to right (Step 4). The learning goal for students is to achieve Step 4 mastery. These steps are meant to help teachers and students identify and celebrate what the students CAN do now and what they need to work on next.

## A Progression Toward Mastery

Assessment Task Item and Standards Assessed	STEP 1 Little evidence of reasoning without a correct answer.  (1 Point)	STEP 2 Evidence of some reasoning without a correct answer.  (2 Points)	STEP 3 Evidence of some reasoning with a correct answer or evidence of solid reasoning with an incorrect answer.  (3 Points)	STEP 4 Evidence of solid reasoning with a correct answer.  (4 Points)
<p style="text-align: center;"><b>1</b></p> <p><b>3.G.1</b> <b>3.MD.8</b> <b>3.OA.8</b></p>	<p>Student may or may not answer any questions correctly. Strategy or reasoning in parts (b) and (c) is inappropriate for the problem.</p> <p>OR</p> <p>Student may answer questions correctly, but student work or reasoning is missing entirely from parts (b) or (c).</p>	<p>Student answers at least two questions correctly. Strategy or reasoning in parts (b) and (c) may be unclear.</p>	<p>Student correctly answers parts (a) and (b) completely. There may be a calculation error in part (c), but work demonstrates strategy or reasoning appropriate to the problem.</p>	<p>Student correctly:</p> <ul style="list-style-type: none"> <li>a. Draws and labels a diagram with a letter to represent the unknown length.</li> <li>b. Finds 34 feet and shows with equations (e.g., <math>16 + 16 + 34 + B = 100</math>, <math>100 - 66 = 34</math>) 34 feet, or written explanation (e.g., the shape is a rectangle because opposite sides of a rectangle are equal, so the unknown side must be 34 feet).</li> <li>c. Answers 81 sq ft. Work demonstrates strategy or reasoning appropriate to the problem (e.g., all four sides of a square are equal, so the sides can be found using <math>36 \div 4 = 9</math>. <math>9 \times 9 = 81</math>).</li> </ul>



## A Progression Toward Mastery

<p style="text-align: center;"><b>2</b></p> <p style="text-align: center;"><b>3.MD.8</b></p>	<p>Student may correctly calculate the unknown side length of one or no shapes.</p>	<p>Student correctly calculates the unknown side length for two or three shapes.</p>	<p>Student correctly calculates the unknown side length for at least four shapes.</p>	<p>Student correctly answers 6 cm as the unknown side length for each shape.</p>
<p style="text-align: center;"><b>3</b></p> <p style="text-align: center;"><b>3.MD.8</b></p>	<p>Student is unable to answer either part of the question correctly.</p>	<p>Student makes an error in calculating either area or perimeter in part (a) that makes the example unhelpful for the explanation in part (b).</p> <p>OR</p> <p>Student may or may not calculate part (a) correctly. In part (b), the explanation is unspecific and may simply state that part (a) proves John is wrong.</p>	<p>Student answers part (a) correctly and identifies that John is incorrect in part (b), but the explanation only specifically mentions area <i>or</i> perimeter.</p>	<p>Student correctly:</p> <ol style="list-style-type: none"> <li>Finds 14 sq cm as the area of each shape and perimeters of 20 cm and 18 cm.</li> <li>Identifies that John is not correct. Explanation includes the argument that area is based on total square units and stays constant as long as the total stays the same, but when square units are rearranged more sides may be exposed, which can change the perimeter.</li> </ol>
<p style="text-align: center;"><b>4</b></p> <p style="text-align: center;"><b>3.MD.4</b> <b>3.MD.8</b></p>	<p>Student is unable to answer any part of the question correctly.</p>	<p>Student:</p> <ol style="list-style-type: none"> <li>Attempts to find perimeters but makes calculation errors. Provides either an unclear explanation or no explanation at all.</li> <li>Completes line plot correctly based on the chart.</li> </ol>	<p>Student completes all parts of the question correctly but may provide an unclear explanation in part (a).</p>	<p>Student correctly:</p> <ol style="list-style-type: none"> <li>Finds all the possible perimeters as 24 cm, 26 cm, 30 cm, 40 cm, and 74 cm. Explanation is appropriate to the problem (e.g., includes finding the factors of 36 and then drawing rectangles with corresponding perimeters and referencing with the chart).</li> <li>Plots the number of students on the line plot.</li> </ol>



## A Progression Toward Mastery

<p>5</p> <p><b>3.G.1</b></p> <p><b>3.MD.8</b></p>	<p>Student is unable to answer any question correctly.</p>	<p>Student answers at least one question correctly.</p>	<p>Student answers at least two questions correctly.</p>	<p>Student correctly:</p> <ul style="list-style-type: none"><li>a. Answers 4 cm. Explanation includes that a square has four equal sides.</li><li>b. Draws a figure with a perimeter of 32 centimeters (e.g., draws three connected squares in a row). (There are many different ways it can be drawn.)</li><li>c. Writes <math>8 \times 4 = 32</math>, <math>4 \times 8 = 32</math>, <math>32 \div 4 = 8</math> or a repeated addition sentence.</li></ul>
---	--	---	--	---

Name Gina

Date \_\_\_\_\_

1. Katy and Jane construct a four-sided wall to surround their castle. The wall has a perimeter of 100 feet. One side measures 16 feet. A different side measures 16 feet. A third side measures 34 feet.
- a. Draw and label a diagram of the wall. Use a letter to represent the unknown side length.

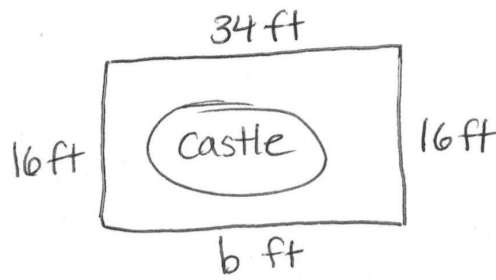

- b. What is the unknown side length? Show your work, or explain how you know.

$$34 + 16 + 16 + b = 100$$

$$\underbrace{\quad\quad}_{66} \quad \underbrace{\quad\quad}_{32}$$

$$100 - 66 = 34$$

The unknown side length is 34 feet.

- c. Katy and Jane build a square fence around the castle's pool. It has a perimeter of 36 feet. What is the area that the fence encloses? Use a letter to represent the unknown. Show your work.

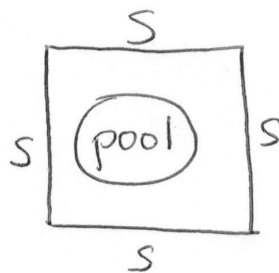

$$P = 36 \text{ ft}$$

All 4 sides are equal, so

$$36 \div 4 = s$$

$$s = 9$$

$$\text{Area} = 9 \text{ ft} \times 9 \text{ ft}$$

$$= 81 \text{ sq ft}$$

The area inside the fence is 81 square feet.

2. Each shape has a missing side length labeled with a letter. The perimeter of the shape is labeled inside. Find the unknown side length for each shape.

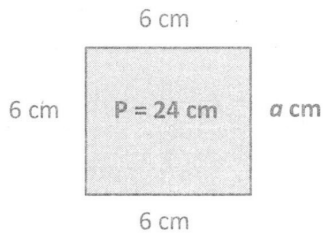

$$6 + 6 + 6 = 18$$

$$18 + a = 24$$

$$a = 6$$

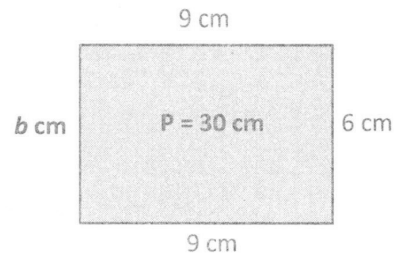

$$9 + 9 + 6 = 24$$

$$\underbrace{\quad}_{18}$$

$$24 + b = 30$$

$$b = 6$$

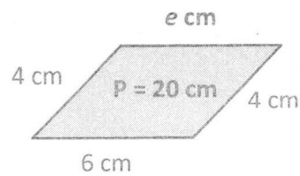

$$4 + 6 + 4 = 14$$

$$\underbrace{\quad}_{10}$$

$$14 + e = 20$$

$$e = 6$$

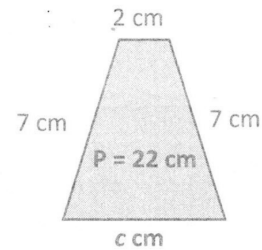

$$7 + 7 + 2 = 16$$

$$\underbrace{\quad}_{14}$$

$$16 + c = 22$$

$$c = 6$$

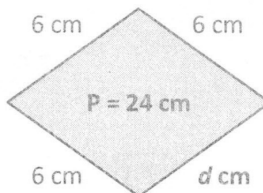

$$6 \times 4 = 24, \text{ so}$$

$$d = 6$$

3. Suppose each  is 1 square centimeter.

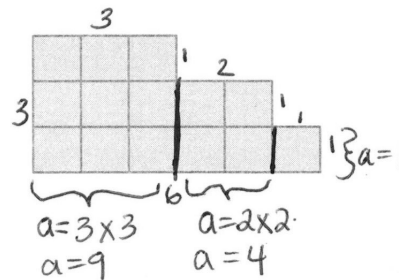
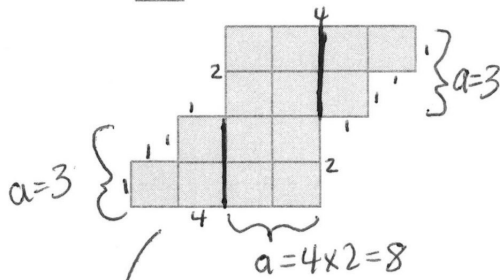

- a. Find the area and perimeter of each shape.

$$A = 8 \text{ sq cm} + 3 \text{ sq cm} + 3 \text{ sq cm}$$

$$A = 14 \text{ sq cm}$$

$$P = 4 \text{ cm} + 4 \text{ cm} + 2 \text{ cm} + 2 \text{ cm} + 8 \text{ cm}$$

$$P = 20 \text{ cm}$$

$$A = 9 \text{ sq cm} + 4 \text{ sq cm} + 1 \text{ sq cm}$$

$$A = 14 \text{ sq cm}$$

$$P = 3 \text{ cm} + 3 \text{ cm} + 6 \text{ cm} + 2 \text{ cm} + 4 \text{ cm}$$

$$6 \text{ cm}$$

$$6 \text{ cm}$$

$$P = 3 \times 6 \text{ cm}$$

$$P = 18 \text{ cm}$$

- b. John says, "If two shapes have the same area, they must also have the same perimeter." Is John correct? Use your answer from Part (a) above to explain why or why not.

John is not correct. The 2 shapes in Part (a) have the same areas but not the same perimeters. The reason is that the shapes are made of the same number of squares (area), but they got rearranged for each shape. Sometimes when you rearrange, you might have more or less sides showing, and that changes the perimeter.

4. Mr. Jackson’s class finds all possible perimeters for a rectangle composed of 36 centimeter tiles. The chart below shows how many students found each rectangle.

Perimeter	Number of Students
24 cm ✓	6
26 cm ✓	9
30 cm ✓	5
40 cm ✓	7
74 cm ✓	4

- a. Check the students’ work. Did they find all the possible perimeters? How do you know?

$$6 \times 6 = 36$$

$$4 \times 9 = 36$$

$$1 \times 36 = 36$$

$$6 \times 6 = 36$$

$$(2 \times 3) \times 6 = 36$$

$$2 \times (3 \times 6) = 36$$

$$2 \times 18 = 36$$

$$6 \times 6 = 36$$

$$(3 \times 2) \times 6 = 36$$

$$3 \times (2 \times 6) = 36$$

$$3 \times 12 = 36$$

Yes, they found all the perimeters. I know because I used a fact I knew to help me find other side lengths. Then I found the perimeters and checked with the chart.

- b. Use the chart. Estimate to construct a line plot of how many students found each perimeter.

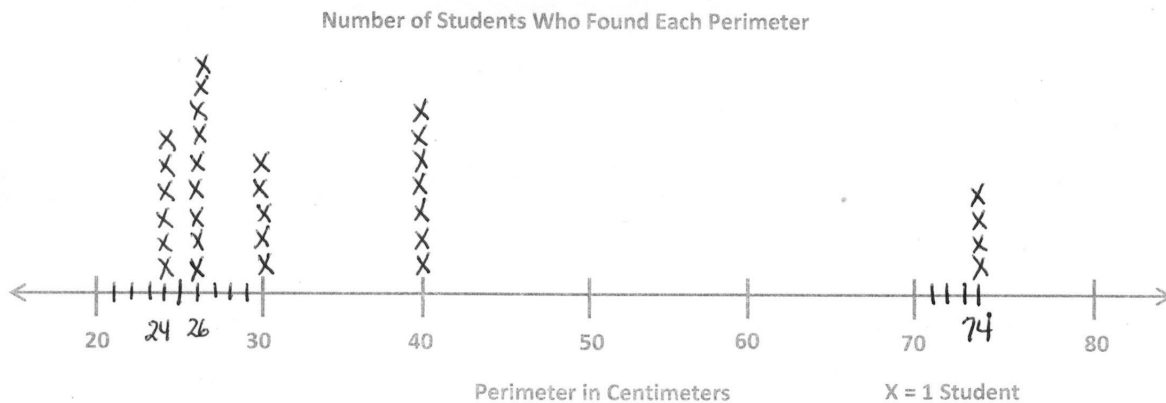



5. The square to the right has an area of 16 square centimeters.  
 a. What is the length of each side? Explain how you know.

$$\underline{4} \times \underline{4} = 16$$

The length of each side is 4cm.  
 Since it's a square all the sides are equal, so I thought about a number that equals 16 when it's multiplied by itself. I know that's 4.

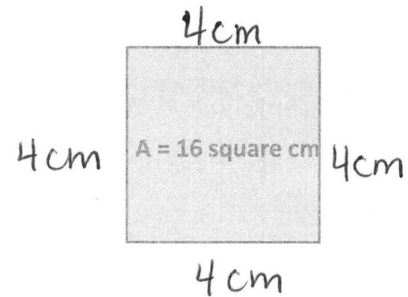

- b. Draw copies of the square above to make a figure with a perimeter of 32 centimeters.

$$32 \div 4 = 8$$

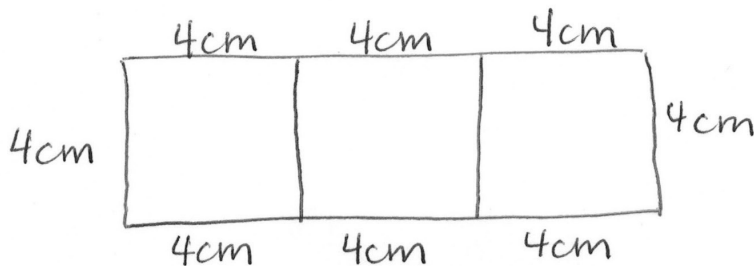

- c. Write a number sentence to show that your figure has the correct perimeter of 32 centimeters.

$$8 \times 4\text{cm} = 32\text{cm}$$



## Topic F

## Year in Review

<b>Instructional Days:</b>	4	
<b>Coherence -Links from:</b>	G2–M8	Time, Shapes, and Fractions as Equal Parts of Shapes
	G3–M3	Multiplication and Division with Units of 0, 1, 6–9, and Multiples of 10
<b>-Links to:</b>	G4–M3	Multi-Digit Multiplication and Division
	G4–M5	Fraction Equivalence, Ordering, and Operations
	G4–M7	Exploring Measurement with Multiplication

In this final topic of Grade 3, students review fundamental skills and prepare resources to maintain their learning during the summer break.

Students create and analyze unusual representations of one-half in Lessons 31 and 32. They analyze the representations created by their peers and discuss whether or not they agree with each representation, finding ways to adjust some representations to accurately reflect one-half. Students' creations can be joined together to create a class paper quilt to display the one-half representations.

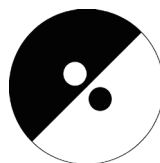

Lesson 33 gives students the opportunity to play fluency games related to a range of Grade 3 skills, including fractions, rounding, multiplication, and division. The lesson includes a variety of fluency activities from which to choose when considering student needs. Students discover fluency games they enjoy playing and decide which ones they would like to continue to play during the summer recess. In Lesson 34, students fold a simple origami booklet to record directions for their favorite fluency games. This booklet becomes a resource for students at home for summer practice.

**A Teaching Sequence of the Year in Review**

**Objective 1: Explore and create unconventional representations of one-half.**  
(Lessons 31–32)

**Objective 2: Solidify fluency with Grade 3 skills.**  
(Lesson 33)

**Objective 3: Create resource booklets to support fluency with Grade 3 skills.**  
(Lesson 34)

## Lesson 31

Objective: Explore and create unconventional representations of one-half.

### Suggested Lesson Structure

■ Fluency Practice	(14 minutes)
■ Application Problem	(6 minutes)
■ Concept Development	(30 minutes)
■ Student Debrief	(10 minutes)
<b>Total Time</b>	<b>(60 minutes)</b>

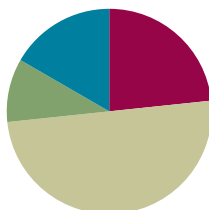

### Fluency Practice (14 minutes)

- Sprint: Multiply or Divide by 9 **3.OA.7** (10 minutes)
- Multiply and Divide **3.OA.7** (4 minutes)

### Sprint: Multiply or Divide by 9 (10 minutes)

Materials: (S) Multiply or Divide by 9 Sprint

Note: This Sprint builds fluency with multiplication and division facts using units of 9.

### Multiply and Divide (4 minutes)

Materials: (S) Personal white board

Note: This activity focuses on student mastery of all products and quotients within 100.

T: (Write  $5 \times 4 = \underline{\quad}$ .) Write the multiplication sentence.

S: (Write  $5 \times 4 = 20$ .)

Continue with the following possible sequence:  $5 \times 8$ ,  $7 \times 8$ ,  $6 \times 4$ ,  $6 \times 8$ ,  $9 \times 8$ , and  $8 \times 9$ .

T: (Write  $6 \div 3 = \underline{\quad}$ .) Write the division sentence.

S: (Write  $6 \div 3 = 2$ .)

Continue with the following possible sequence:  $15 \div 3$ ,  $30 \div 6$ ,  $18 \div 3$ ,  $36 \div 6$ ,  $14 \div 7$ ,  $28 \div 7$ , and  $56 \div 7$ .

T: (Write 3, 2.) Write two multiplication sentences and two division sentences using these factors.

S: (Write  $3 \times 2 = 6$ ,  $2 \times 3 = 6$ ,  $6 \div 2 = 3$ , and  $6 \div 3 = 2$ .)

Continue with the following possible sequence: 9 and 5, 6 and 4, and 7 and 8.



#### NOTES ON MULTIPLE MEANS OF ACTION AND EXPRESSION:

Support students working below grade level during the Multiply and Divide fluency activity by coupling language and number sentences with models such as tape diagrams, number bonds, and arrays. It may be helpful to repeat exercises until students gain ease and confidence.

**Application Problem (6 minutes)**

Mara draws a 6-inch by 8-inch rectangle. She shades one-half of the rectangle. What is the area of the shaded part of Mara's rectangle?

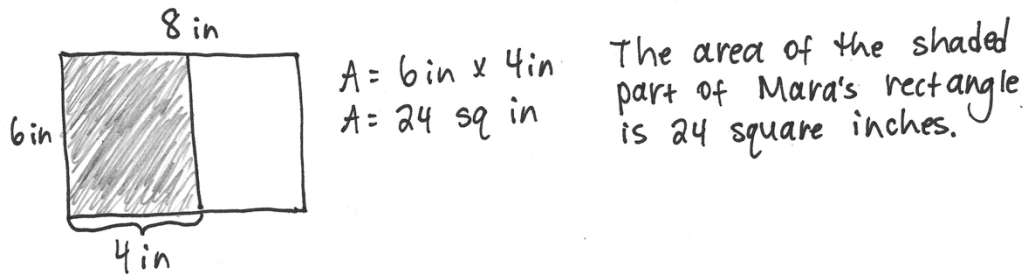

Note: Students may also divide the rectangle lengthwise and get an 8-inch by 3-inch rectangle or find the area of the whole rectangle and divide it by 2. This problem reviews calculating area from Module 4. Invite students to discuss how this problem could be solved using reasoning skills and mental math.

**Concept Development (30 minutes)**

Materials: (S) Squares (Template), ruler, crayons, Problem Set

**Part 1: Explore different representations of one-half.**

Project the following images.

T: Study these images. Estimate to decide which shapes have one-half shaded. Discuss your reasoning with a partner.

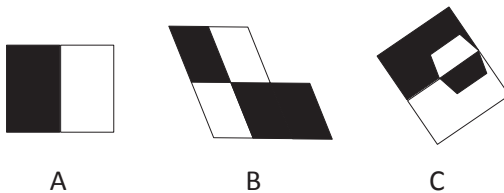

S: Shape A definitely does because the black and white parts look like they are the same size. → I think Shape C does, too, because that little black trapezoid just got cut out and flipped over. The black and white parts still look equal. → I do not think Shape B shows one-half shaded. That bottom black part looks like it is made of two parallelograms, not one. That means that three are shaded and two are not. Three shaded parallelograms are more than one-half of that shape.

T: I heard many students mention same-sized, or equal, parts. Tell your partner why equal parts are important when we are talking about one-half.

S: If the parts are the same size and the same number of parts are shaded and unshaded, then we know we have one-half. If the parts are not equal, we cannot really tell. → You can compare the number of shaded and unshaded parts when shapes are divided up into equal parts. Like my friend did when she was talking about Shape B. Three out of 5 parts are shaded.

T: When I asked you to study the shapes, I said you should *estimate* to decide which represent one-half. Why did I use the word *estimate*?

S: Because you wanted us to look at them and take a guess. → We do not really know for sure if the parts are equal just by looking at them. It seems like it, but they could be a little different. → To be sure, we would have to measure or maybe make the shapes ourselves out of unit squares or something.

T: Let's do that now. I'll pass out squares with grids in them that will help you be precise in showing one-half. Instead of making my shapes, make your own representations. Be as creative as you can!

MP.6

### Part 2: Create different representations of one-half of a 6 by 6 square.

Give each student a copy of the squares Template. Students shade each square to show different ways to represent one-half of a 36-square-unit square (in pencil). Students then trade squares with a partner to analyze each other's work. The Problem Set is a tool for students to use to record their analyses of their partners' work. After the analyses, students can make adjustments to their work, if necessary.

Prepare students by doing the following:

- Students should create between 4 and 10 different representations of one-half using the squares Template.
- Students should label each square with a letter so partners can refer to squares by the letter name.
- If necessary, review strategies that students can use to shade in one-half of a unit square.
- After representations are made, students analyze each other's work to confirm that squares are, in fact, one-half shaded.
- Show a completed Problem Set (analyzing tool) to establish your expectation for student analysis.

Once every student has made at least four representations, guide an analysis of the representations to confirm that they accurately represent one-half. Students may work in pairs to do this or participate in a gallery walk. Students can use the Problem Set as a tool to record their analyses.



#### NOTES ON MULTIPLE MEANS OF ENGAGEMENT:

As students make unconventional representations of one-half, offer autonomy and choice to those working above grade level and others.

Encourage student creativity by making the exploration as open-ended as possible. For example, students might cut or combine their 36 unit squares to extend the variety of designs and increase the challenge of partner analysis.



#### NOTES ON MULTIPLE MEANS OF ACTION AND EXPRESSION:

If the 36-square-unit square is too small or otherwise challenging for some learners, magnify it, and present it on an interactive board or a computer.

When the analysis is complete and mistakes are corrected, students can use crayons to color over their pencil shadings. Combine all the finished squares to form a class quilt to display the various representations of one-half.

### Student Debrief (10 minutes)

**Lesson Objective:** Explore and create unconventional representations of one-half.

The Student Debrief is intended to invite reflection and active processing of the total lesson experience.

Invite students to review their solutions for the Problem Set. They should check work by comparing answers with a partner before going over answers as a class. Look for misconceptions or misunderstandings that can be addressed in the Debrief. Guide students in a conversation to debrief the Problem Set and process the lesson.

Any combination of the questions below may be used to lead the discussion.

- Look at our class quilt. How is it possible to have so many different ways to show one-half of the same square?
- What is the area in square units of the shaded part of each of your squares? How do you know?
- What fraction of our class quilt is shaded in? How do you know?
- Did anyone shade in one-half of a unit square? How? Are there other ways to shade in one-half of a unit square?
- How did the Application Problem connect to today's lesson?

### Exit Ticket (3 minutes)

After the Student Debrief, instruct students to complete the Exit Ticket. A review of their work will help with assessing students' understanding of the concepts that were presented in today's lesson and planning more effectively for future lessons. The questions may be read aloud to the students.

Name Gina Date \_\_\_\_\_

Use this form to analyze your classmate's representations of one-half shaded.

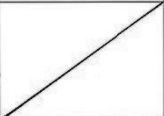
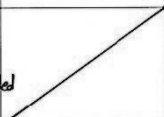
Square (letter)	Does this square show one-half shaded?	Explain why or why not.	Describe changes to make so the square shows one-half shaded.
A	Yes	It's one-half shaded in because the two halves of the square look like opposites of each other and they fit together to make one whole.	
B	No	It's not one-half shaded, because you have too many half unit squares shaded.	Erase the shading in one of the half shaded unit squares.
C	No	It's not one-half shaded because you don't have enough squares shaded.	Shade 2 full squares or maybe even 4 half squares.
D	Yes	It's one-half shaded because there are 3 shaded parts and 3 equal sized unshaded parts.	

## A

Number Correct: \_\_\_\_\_

Multiply or Divide by 9

1.	$2 \times 9 =$	
2.	$3 \times 9 =$	
3.	$4 \times 9 =$	
4.	$5 \times 9 =$	
5.	$1 \times 9 =$	
6.	$18 \div 9 =$	
7.	$27 \div 9 =$	
8.	$45 \div 9 =$	
9.	$9 \div 9 =$	
10.	$36 \div 9 =$	
11.	$6 \times 9 =$	
12.	$7 \times 9 =$	
13.	$8 \times 9 =$	
14.	$9 \times 9 =$	
15.	$10 \times 9 =$	
16.	$72 \div 9 =$	
17.	$63 \div 9 =$	
18.	$81 \div 9 =$	
19.	$54 \div 9 =$	
20.	$90 \div 9 =$	
21.	$\underline{\quad} \times 9 = 45$	
22.	$\underline{\quad} \times 9 = 9$	

23.	$\underline{\quad} \times 9 = 90$	
24.	$\underline{\quad} \times 9 = 18$	
25.	$\underline{\quad} \times 9 = 27$	
26.	$90 \div 9 =$	
27.	$45 \div 9 =$	
28.	$9 \div 9 =$	
29.	$18 \div 9 =$	
30.	$27 \div 9 =$	
31.	$\underline{\quad} \times 9 = 54$	
32.	$\underline{\quad} \times 9 = 63$	
33.	$\underline{\quad} \times 9 = 81$	
34.	$\underline{\quad} \times 9 = 72$	
35.	$63 \div 9 =$	
36.	$81 \div 9 =$	
37.	$54 \div 9 =$	
38.	$72 \div 9 =$	
39.	$11 \times 9 =$	
40.	$99 \div 9 =$	
41.	$12 \times 9 =$	
42.	$108 \div 9 =$	
43.	$14 \times 9 =$	
44.	$126 \div 9 =$	



## B

Number Correct: \_\_\_\_\_

Improvement: \_\_\_\_\_

Multiply or Divide by 9

1.	$1 \times 9 =$	
2.	$2 \times 9 =$	
3.	$3 \times 9 =$	
4.	$4 \times 9 =$	
5.	$5 \times 9 =$	
6.	$27 \div 9 =$	
7.	$18 \div 9 =$	
8.	$36 \div 9 =$	
9.	$9 \div 9 =$	
10.	$45 \div 9 =$	
11.	$10 \times 9 =$	
12.	$6 \times 9 =$	
13.	$7 \times 9 =$	
14.	$8 \times 9 =$	
15.	$9 \times 9 =$	
16.	$63 \div 9 =$	
17.	$54 \div 9 =$	
18.	$72 \div 9 =$	
19.	$90 \div 9 =$	
20.	$81 \div 9 =$	
21.	$\_\_\_ \times 9 = 9$	
22.	$\_\_\_ \times 9 = 45$	

23.	$\_\_\_ \times 9 = 18$	
24.	$\_\_\_ \times 9 = 90$	
25.	$\_\_\_ \times 9 = 27$	
26.	$18 \div 9 =$	
27.	$9 \div 9 =$	
28.	$90 \div 9 =$	
29.	$45 \div 9 =$	
30.	$27 \div 9 =$	
31.	$\_\_\_ \times 9 = 27$	
32.	$\_\_\_ \times 9 = 36$	
33.	$\_\_\_ \times 9 = 81$	
34.	$\_\_\_ \times 9 = 63$	
35.	$72 \div 9 =$	
36.	$81 \div 9 =$	
37.	$54 \div 9 =$	
38.	$63 \div 9 =$	
39.	$11 \times 9 =$	
40.	$99 \div 9 =$	
41.	$12 \times 9 =$	
42.	$108 \div 9 =$	
43.	$13 \times 9 =$	
44.	$117 \div 9 =$	

Name \_\_\_\_\_

Date \_\_\_\_\_

Use this form to analyze your classmate's representations of one-half shaded.

Square (letter)	Does this square show one-half shaded?	Explain why or why not.	Describe changes to make so the square shows one-half shaded.

Name \_\_\_\_\_

Date \_\_\_\_\_

Marty shades the square as shown below and says one-half of the big square is shaded. Do you agree? Why or why not?

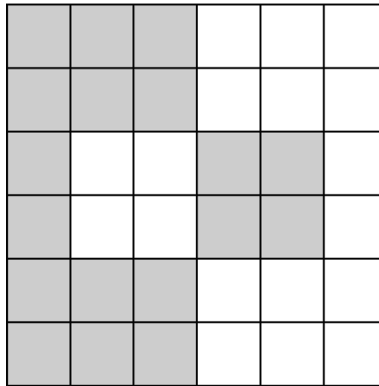

Name \_\_\_\_\_

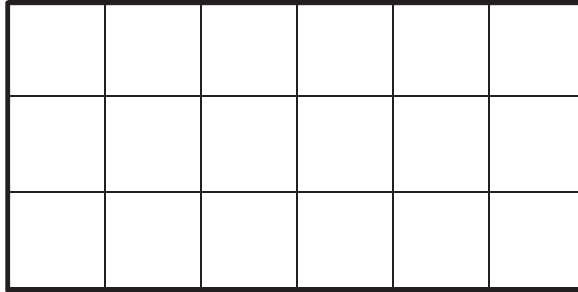

Date \_\_\_\_\_

1. Use the rectangle below to answer Problem 1(a–d).



- a. What is the area of the rectangle in square units?
- b. What is the area of half of the rectangle in square units?
- c. Shade in half of the rectangle above. Be creative with your shading!
- d. Explain how you know you shaded in half of the rectangle.

2. During math class, Arthur, Emily, and Gia draw a shape and then shade one-half of it. Analyze each student's work. Determine if each student was correct or not, and explain your thinking.

Student	Drawing	Your Analysis
Arthur		
Emily		
Gia		

3. Shade the grid below to show two different ways of shading half of each shape.

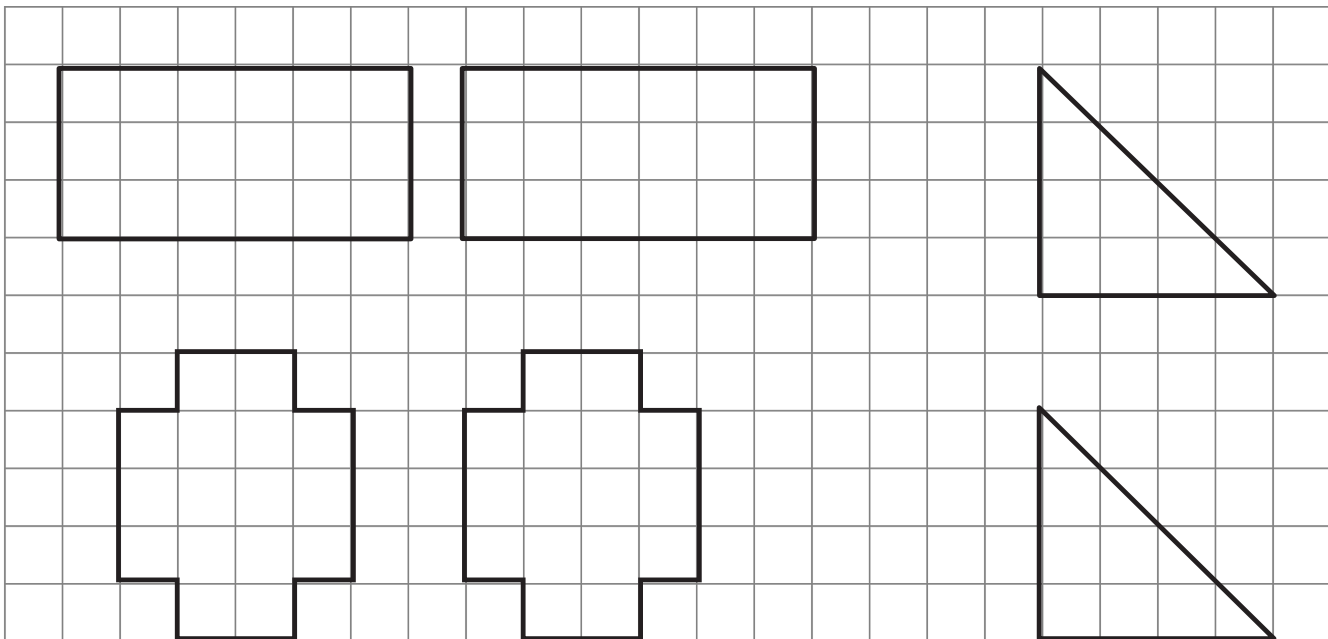

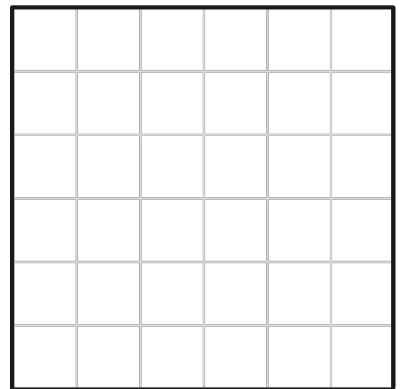
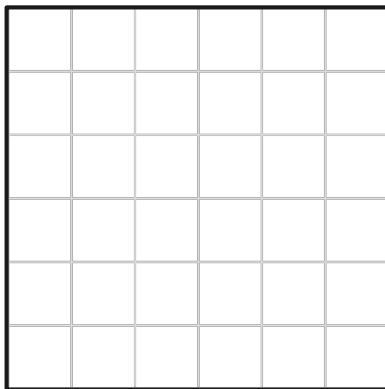
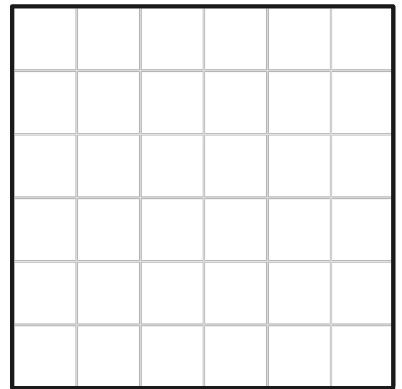
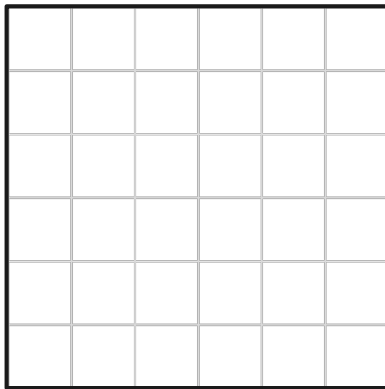
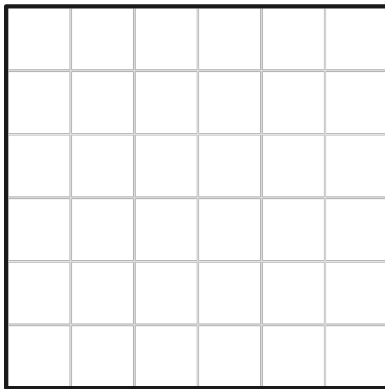
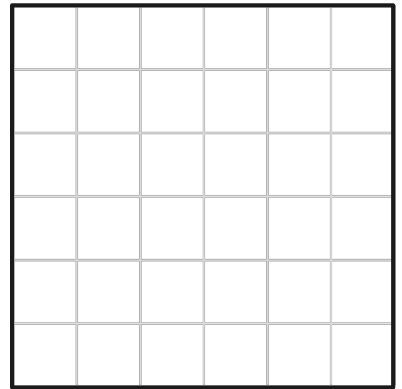
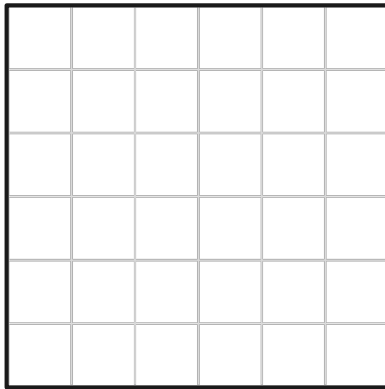
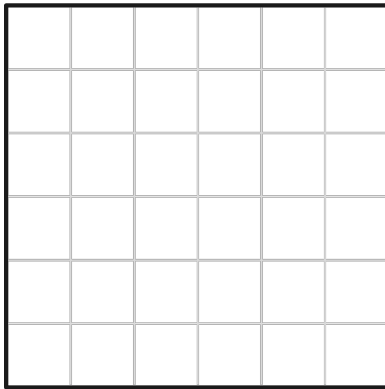
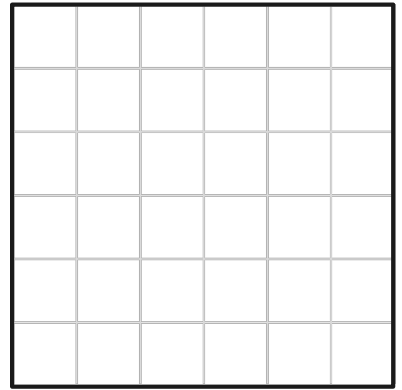
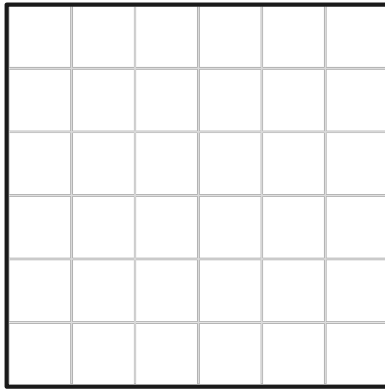
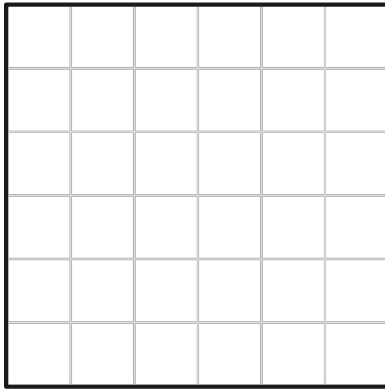

---

squares

## Lesson 32

Objective: Explore and create unconventional representations of one-half.

### Suggested Lesson Structure

■ Fluency Practice	(13 minutes)
■ Application Problem	(7 minutes)
■ Concept Development	(30 minutes)
■ Student Debrief	(10 minutes)
<b>Total Time</b>	<b>(60 minutes)</b>

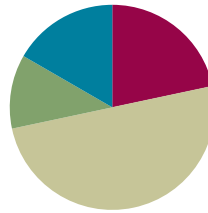

### Fluency Practice (13 minutes)

- Sprint: Mixed Multiplication **3.OA.7** (10 minutes)
- Divide **3.OA.7** (3 minutes)

### Sprint: Mixed Multiplication (10 minutes)

Materials: (S) Mixed Multiplication Sprint

Note: This Sprint focuses on student mastery of all products of one-digit numbers.

### Divide (3 minutes)

Materials: (S) Personal white board

Note: This activity focuses on student mastery of all quotients within 100.

T: (Write  $10 \div 2 = \underline{\quad}$ .) Say the division sentence.

S:  $10 \div 2 = 5$ .

Continue with the following possible sequence:  $4 \div 2$ ,  $8 \div 4$ , and  $15 \div 3$ .

T: (Write  $24 \div 4 = \underline{\quad}$ .) Write the answer.

S: (Write  $24 \div 4 = 6$ .)

Continue with the following possible sequence:  $45 \div 9$ ,  $63 \div 7$ ,  $48 \div 6$ ,  $56 \div 8$ , and  $81 \div 9$ .

### Application Problem (7 minutes)

Hannah traces square-inch tiles to draw 3 larger squares. She draws the 3 large squares side by side to make a rectangle. She shades one-half of each larger square, as shown.

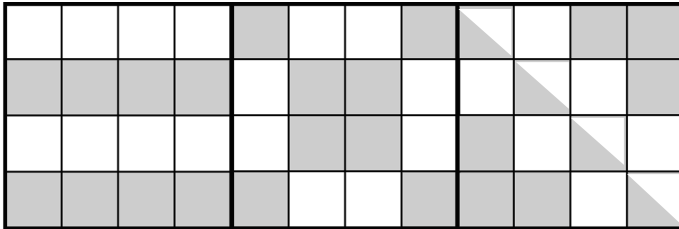

- Do you agree that all 3 squares are one-half shaded? Explain your answer.
- What is the area of the rectangle?
- What is the total area of the shaded space?

a. Yes, I agree that all 3 squares are one-half shaded. Each square has an area of 16 sq in and each square has a total of 8 sq in shaded. 8 is one-half of 16.

b. 
$$A = 4 \text{ in} \times (10 \text{ in} + 2 \text{ in})$$

$$= (4 \text{ in} \times 10 \text{ in}) + (4 \text{ in} \times 2 \text{ in})$$

$$= 40 \text{ sq in} + 8 \text{ sq in}$$

$$= 48 \text{ sq in}$$
 The area of the rectangle is 48 square inches.

c. Area of shaded space of 1 square = 8 sq in

$$A = 3 \times 8 \text{ sq in}$$

$$= 24 \text{ sq in}$$
 The area of the shaded space is 24 square inches.

Note: Today's Application Problem reviews the concept of unconventional representations of one-half from Lesson 31.

### Concept Development (30 minutes)

Materials: (T) Completed page 1 sample of Problem Set (analyzing tool) (S) Circles with dots (Template), ruler, crayons, scissors, Problem Set

Distribute the Template to the students, and instruct them to cut out the circles.

MP.6

- T: Let's represent one-half using our circles. They don't have a grid like yesterday's squares did. Talk with your partner about what tools or strategies you might use to help you be precise as you show one-half.
- S: We can fold the circle in half and use the fold line for help. → Or we could use rulers. → That little dot looks like it's in the middle. If we fold or draw from that, it should be pretty close to one-half.

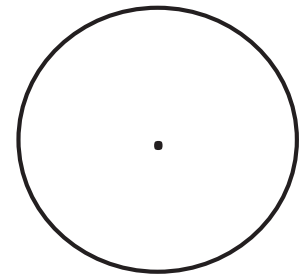



- T: Go ahead and fold one circle to estimate one-half now.
- S: (Fold.)
- T: Take your second circle. Fold it in half, and then fold it in half again. (Model.) Open your circle. What fractional unit did you divide your circle into?
- S: Fourths!
- T: Why might fourths be useful for representing one-half?
- S: If you color in two, it'll be one-half, just like before. → True, but you can also color the fourths that are diagonal from each other to get a little more interesting with your one-half.
- T: Fold your fourths back up, and then fold the circle in half for a third time. What fractional unit is your circle divided into now?
- S: Eighths!
- T: Talk to your partner about how that increases the possibilities for showing one-half.
- S: (Discuss.)
- T: Besides folding your circle into different fractional units, how else could you get creative about the way you show one-half with your circle?
- S: You could use your eraser to erase dots from the shaded spot and then redraw them on the unshaded parts. → Or you could use your ruler to measure shapes inside the shaded part and then erase them and redraw them on the unshaded part.
- T: Use folding and other ideas to create different, creative representations of one-half.
- S: (Work to create representations using the four circles.)

Once every student has made at least four representations, guide an analysis of the representations to confirm that they accurately represent one-half. Have students work in pairs to do this, or set up a gallery walk.

- MP.6** T: Do all of our circles represent exactly one-half? Talk with your partner. Why or why not?
- S: Mine do. I measured them with a ruler. → I don't know about that. It's hard to draw a perfectly straight line from the middle, even with a ruler. → Mine aren't exact. I folded.
- T: We did a lot of estimating with our circles, so we can say that our circles show representations of about one-half.

If time allows, encourage students to present their circles to a small group and explain how they know they shaded about one-half of their circles. After explanations, students should correct any mistakes. To finish the lesson, students can use crayons to color over their pencil shading. Combine all the finished circles to form a class quilt to display the various representations of one-half.

### Problem Set (10 minutes)

Students should do their personal best to complete the Problem Set within the allotted 10 minutes. For some classes, it may be appropriate to modify the assignment by specifying which problems they work on first. Some problems do not specify a method for solving. Students should solve these problems using the RDW approach used for Application Problems.

## Student Debrief (10 minutes)

**Lesson Objective:** Explore and create unconventional representations of one-half.

The Student Debrief is intended to invite reflection and active processing of the total lesson experience.

Invite students to review their solutions for the Problem Set. They should check work by comparing answers with a partner before going over answers as a class. Look for misconceptions or misunderstandings that can be addressed in the Debrief. Guide students in a conversation to debrief the Problem Set and process the lesson.

Any combination of the questions below may be used to lead the discussion.

- Share answers to Problem 1(b). Were any of the circles that we made today exactly one-half shaded? How do you know?
- Look at Circle A in Problem 2. Is it one-half shaded? How do you know? What do we have to think is true about the small black and white circles? About the black and white swirls? Why?
- Compare the circle you shaded in Problem 3 to a partner's. How are they the same? How are they different?
- How was the shading we did with circles similar to the shading we did with rectangles? How was it different?
- Why do you think it's helpful to explore different representations of one-half?

## Exit Ticket (3 minutes)

After the Student Debrief, instruct students to complete the Exit Ticket. A review of their work will help with assessing students' understanding of the concepts that were presented in today's lesson and planning more effectively for future lessons. The questions may be read aloud to the students.

Name Gina Date \_\_\_\_\_

1. Look at the circles you shaded today. Glue a circle that is about one-half shaded in the space below.



a. Explain the strategy you used to shade in one-half of your circle.  
I folded my circle to make fourths. Then I colored in 2 parts. I erased 2 shapes from each part and estimated to color the same shapes in the unshaded parts.

b. Is your circle exactly one-half shaded? Explain your answer.  
No, my circle is not exactly one-half shaded because I estimated to draw shapes that were the same size as the shapes I erased.

2. Julian shades 4 circles as shown below.



a. Write the letters of the circles that are about one-half shaded.  
A, C, and D.

b. Choose one circle from your answer to Part (a) and explain how you know it's about one-half shaded.  
Circle D  
I know it's about one-half shaded because there are 6 shaded parts and 6 unshaded parts. The shaded and unshaded parts are equal.

c. Choose one circle that you did not list in Part (a), and explain how it could be changed so that it is about one-half shaded.  
Circle B  
The hearts in Circle B need to be changed to the plus signs in the shaded parts. Then the circle would be about one-half shaded.

3. Read the clues to help you shade the circle below.

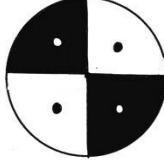

a. Divide the circle into 4 equal parts.  
b. Shade in 2 parts.  
c. Erase a small circle from each shaded part.  
d. Estimate to draw and shade 2 circles in the unshaded parts that are the same size as the circles you erased in Part (c).

4. Did you shade in one-half of the circle in Problem 3? How do you know?  
Yes, I shaded about one-half of the circle in Problem 3. I know because the shaded amount is about the same as the unshaded amount.

## A

Number Correct: \_\_\_\_\_

## Mixed Multiplication

1.	$2 \times 1 =$	
2.	$2 \times 2 =$	
3.	$2 \times 3 =$	
4.	$4 \times 1 =$	
5.	$4 \times 2 =$	
6.	$4 \times 3 =$	
7.	$1 \times 6 =$	
8.	$2 \times 6 =$	
9.	$1 \times 8 =$	
10.	$2 \times 8 =$	
11.	$3 \times 1 =$	
12.	$3 \times 2 =$	
13.	$3 \times 3 =$	
14.	$5 \times 1 =$	
15.	$5 \times 2 =$	
16.	$5 \times 3 =$	
17.	$1 \times 7 =$	
18.	$2 \times 7 =$	
19.	$1 \times 9 =$	
20.	$2 \times 9 =$	
21.	$2 \times 5 =$	
22.	$2 \times 6 =$	

23.	$2 \times 7 =$	
24.	$5 \times 5 =$	
25.	$5 \times 6 =$	
26.	$5 \times 7 =$	
27.	$4 \times 5 =$	
28.	$4 \times 6 =$	
29.	$4 \times 7 =$	
30.	$3 \times 5 =$	
31.	$3 \times 6 =$	
32.	$3 \times 7 =$	
33.	$2 \times 7 =$	
34.	$2 \times 8 =$	
35.	$2 \times 9 =$	
36.	$5 \times 7 =$	
37.	$5 \times 8 =$	
38.	$5 \times 9 =$	
39.	$4 \times 7 =$	
40.	$4 \times 8 =$	
41.	$4 \times 9 =$	
42.	$3 \times 7 =$	
43.	$3 \times 8 =$	
44.	$3 \times 9 =$	

## B

Number Correct: \_\_\_\_\_

Improvement: \_\_\_\_\_

## Mixed Multiplication

1.	$5 \times 1 =$	
2.	$5 \times 2 =$	
3.	$5 \times 3 =$	
4.	$3 \times 1 =$	
5.	$3 \times 2 =$	
6.	$3 \times 3 =$	
7.	$1 \times 7 =$	
8.	$2 \times 7 =$	
9.	$1 \times 9 =$	
10.	$2 \times 9 =$	
11.	$2 \times 1 =$	
12.	$2 \times 2 =$	
13.	$2 \times 3 =$	
14.	$4 \times 1 =$	
15.	$4 \times 2 =$	
16.	$4 \times 3 =$	
17.	$1 \times 6 =$	
18.	$2 \times 6 =$	
19.	$1 \times 8 =$	
20.	$2 \times 8 =$	
21.	$5 \times 5 =$	
22.	$5 \times 6 =$	

23.	$5 \times 7 =$	
24.	$2 \times 5 =$	
25.	$2 \times 6 =$	
26.	$2 \times 7 =$	
27.	$3 \times 5 =$	
28.	$3 \times 6 =$	
29.	$3 \times 7 =$	
30.	$4 \times 5 =$	
31.	$4 \times 6 =$	
32.	$4 \times 7 =$	
33.	$5 \times 7 =$	
34.	$5 \times 8 =$	
35.	$5 \times 9 =$	
36.	$2 \times 7 =$	
37.	$2 \times 8 =$	
38.	$2 \times 9 =$	
39.	$3 \times 7 =$	
40.	$3 \times 8 =$	
41.	$3 \times 9 =$	
42.	$4 \times 7 =$	
43.	$4 \times 8 =$	
44.	$4 \times 9 =$	

Name \_\_\_\_\_

Date \_\_\_\_\_

1. Look at the circles you shaded today. Glue a circle that is about one-half shaded in the space below.

a. Explain the strategy you used to shade in one-half of your circle.

b. Is your circle exactly one-half shaded? Explain your answer.

2. Julian shades 4 circles as shown below.



Circle A



Circle B



Circle C

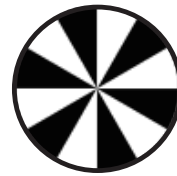

Circle D

a. Write the letters of the circles that are about one-half shaded.

- b. Choose one circle from your answer to Part (a), and explain how you know it's about one-half shaded.

Circle \_\_\_\_\_

- c. Choose one circle that you did not list in Part (a), and explain how it could be changed so that it is about one-half shaded.

Circle \_\_\_\_\_

3. Read the clues to help you shade the circle below.

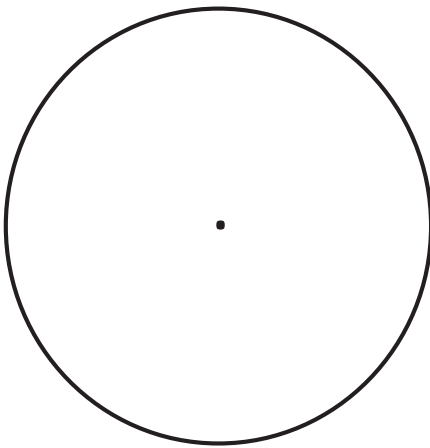

- Divide the circle into 4 equal parts.
- Shade in 2 parts.
- Erase a small circle from each shaded part.
- Estimate to draw and shade 2 circles in the unshaded parts that are the same size as the circles you erased in Part (c).

4. Did you shade in one-half of the circle in Problem 3? How do you know?

Name \_\_\_\_\_

Date \_\_\_\_\_

Riddian shades a circle as shown below.

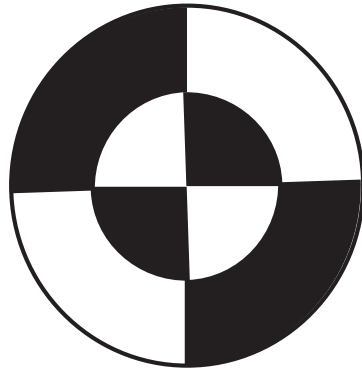

1. Is Riddian's shape about one-half shaded? How do you know?

2. Estimate to shade about one-half of the circle in an unusual way.

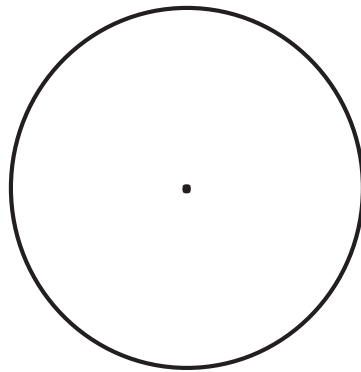

Name \_\_\_\_\_

Date \_\_\_\_\_

1. Estimate to finish shading the circles below so that each circle is about one-half shaded.

a.

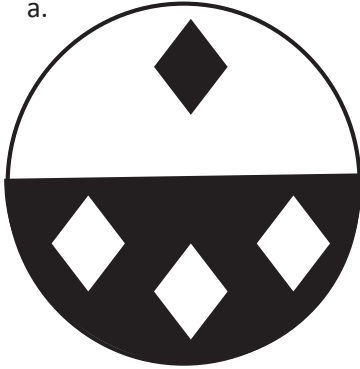

b.

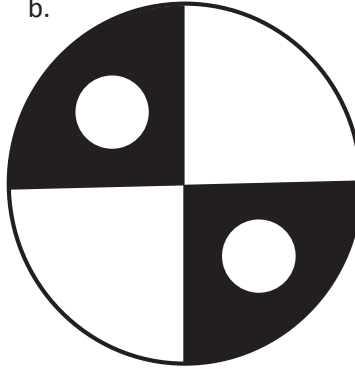

c.

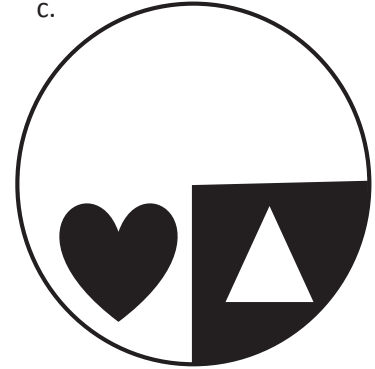

2. Choose one of the circles in Problem 1, and explain how you know it's about one-half shaded.

Circle \_\_\_\_\_

3. Can you say the circles in Problem 1 are exactly one-half shaded? Why or why not?



4. Marissa and Jake shade in circles as shown below.

Marissa's Circle

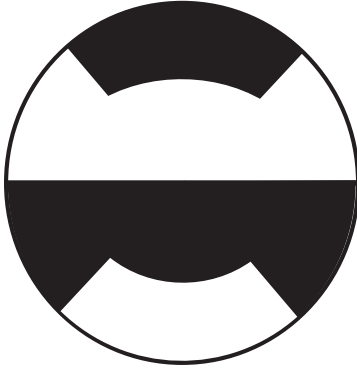

Jake's Circle

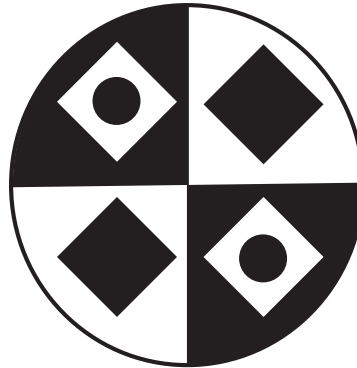

- a. Whose circle is about one-half shaded? How do you know?
- b. Explain how the circle that is not one-half shaded can be changed so that it is one-half shaded.

5. Estimate to shade about one-half of each circle below in an unusual way.

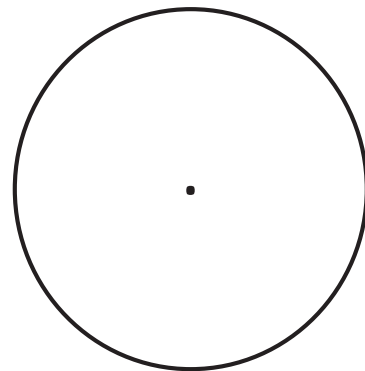
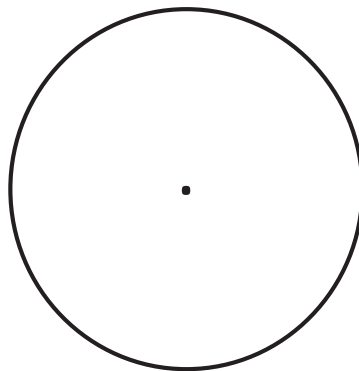
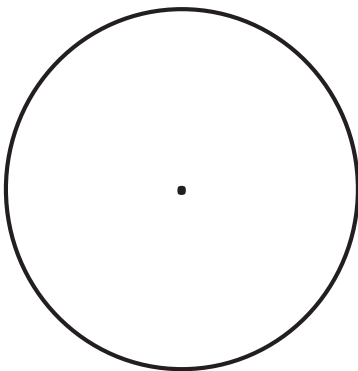

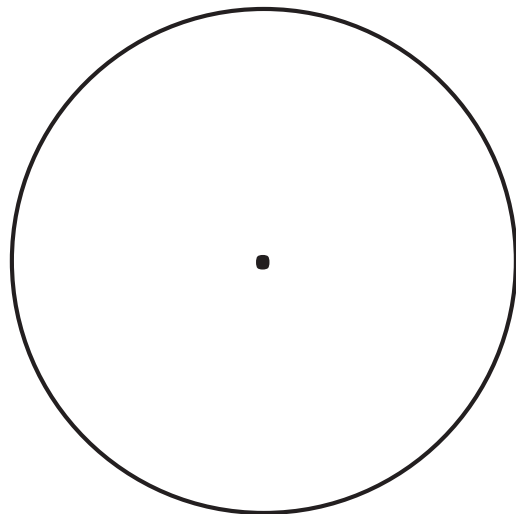
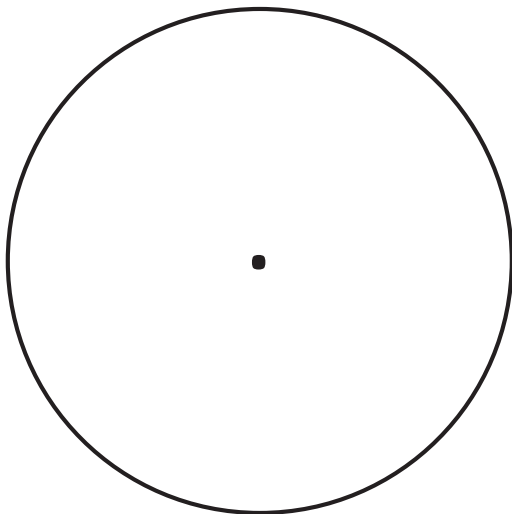
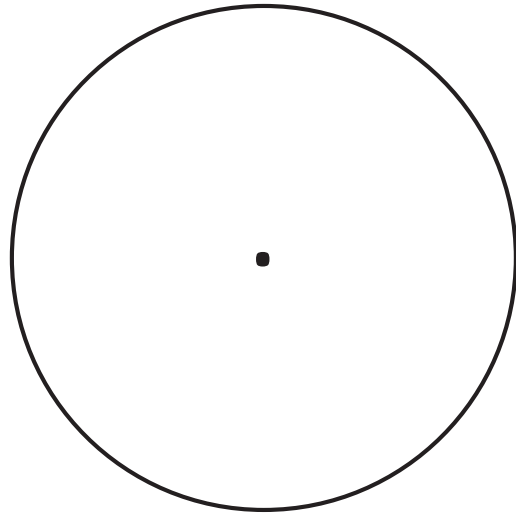
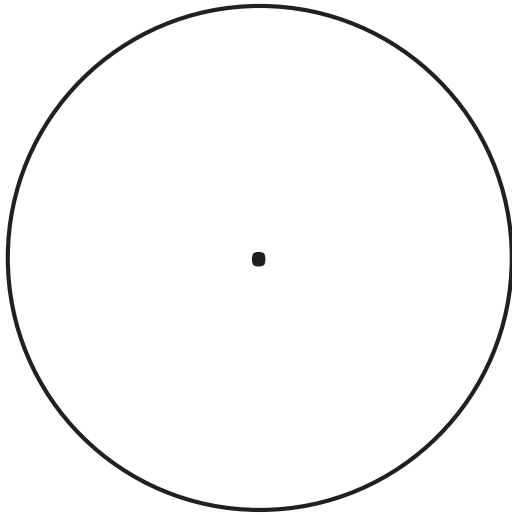
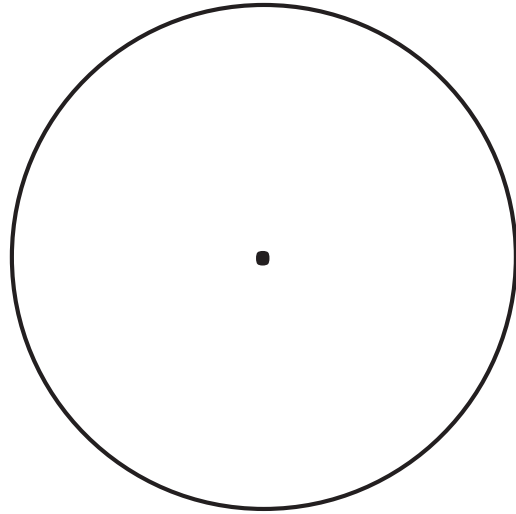
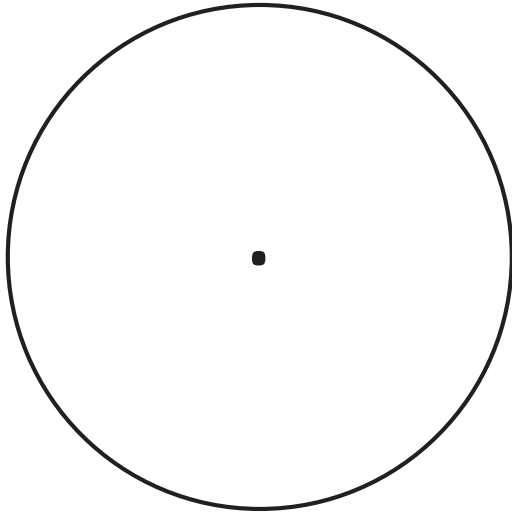

---

circles with dots

## Lesson 33

Objective: Solidify fluency with Grade 3 skills.

### Suggested Lesson Structure

■ Fluency Practice	(50 minutes)
■ Student Debrief	(10 minutes)
<b>Total Time</b>	<b>(60 minutes)</b>

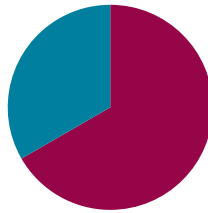

### Fluency Practice (50 minutes)

- Sprint: Mixed Division **3.OA.7** (10 minutes)
- Multiply **3.OA.7** (3 minutes)
- Mixed Review Games (37 minutes)

#### Sprint: Mixed Division (10 minutes)

Materials: (S) Mixed Division Sprint

Note: This Sprint focuses on student mastery of all quotients within 100.

#### Multiply (3 minutes)

Materials: (S) Personal white board

Note: This activity focuses on student mastery of all products of two one-digit numbers.

T: (Write  $4 \times 2 = \underline{\quad}$ .) Say the multiplication sentence.

S:  $4 \times 2 = 8$ .

Continue with the following possible sequence:  $3 \times 4$ ,  $4 \times 4$ , and  $5 \times 6$ .

T: (Write  $7 \times 6 = \underline{\quad}$ .) Write the answer.

S: (Write 42.)

Continue with the following possible sequence:  $8 \times 7$  and  $9 \times 6$ .

T: (Write  $3 \times 2 = \underline{\quad}$ .) Say the multiplication sentence.

S:  $3 \times 2 = 6$ .

T: Flip the factors, and say it.

S:  $2 \times 3 = 6$ .

Continue with the following possible sequence:  $6 \times 3$ ,  $7 \times 5$ ,  $7 \times 6$ , and  $9 \times 8$ .



#### NOTES ON MULTIPLE MEANS OF REPRESENTATION:

Clarify the expression “flip the factors” for English language learners and others. Explain that students are to switch the placement of the factors in the multiplication sentence. It may be helpful to give an example.

## Mixed Review Games (37 minutes)

Materials: (S) Fluency game materials (listed with each activity and included at the end of the lesson), Problem Set

For the rest of today's lesson, students review and play fluency games from Grade 3. They play in pairs, alternating the role of teacher. Students might periodically move around the room selecting different partners or stay in the same grouping for the duration of this practice. Choose a few ideas from the suggested games, and let students choose which ones to play, or select other fluency activity favorites based on the needs and interests of the class.

Students should have their Problem Sets with them as they play the fluency games and use them to keep a list of their favorite activities. They reference the list in Lesson 34 when recording the directions for their favorites in a summer practice booklet.

## Student Debrief (10 minutes)

**Lesson Objective:** Solidify fluency with Grade 3 skills.

The Student Debrief is intended to invite reflection and active processing of the total lesson experience.

Invite students to review their solutions for the Problem Set. They should check work by comparing answers with a partner before going over answers as a class. Look for misconceptions or misunderstandings that can be addressed in the Debrief. Guide students in a conversation to debrief the Problem Set and process the lesson.

Any combination of the questions below may be used to lead the discussion.

- What is something you did today that you could not do before you came to the third grade?
- Are there any activities that were still a little challenging? What might you do to get better?
- Which of these games might be fun to play over the summer so you can keep your math skills sharp? Who will you teach to play with you?



### NOTES ON MULTIPLE MEANS OF ENGAGEMENT:

These are games that students can play with family members to maintain skills over the summer. It may be appropriate to invite parents and siblings to learn and participate. This might be done at a math or parents' night. Students may consider who their game partners might be at home and make adjustments accordingly. For example, if played with a younger or an older sibling, games may include math appropriate for siblings. Discuss with students how to best adapt the games for their personal summer experiences.

Name: Gina Date: \_\_\_\_\_

List some games we played today in the chart below. Place a check mark in the box that shows how you felt about your level of fluency as you played each activity. Check off the last column if you would like to practice this activity over the summer.

Activity	I still need some practice with my facts.	I am fluent.	I would like to put this in my summer activity book.
1. Array Multiplication		✓	✓
2. Commutative Multiplying		✓	✓
3. Rename Tens	✓		✓
4. Make Tens and Hundreds	✓		✓
5. Partition Shapes		✓	✓
6. Draw Fractions from Part to Whole	✓		✓
7.			
8.			

**Exit Ticket (3 minutes)**

After the Student Debrief, instruct students to complete the Exit Ticket. A review of their work will help with assessing students' understanding of the concepts that were presented in today's lesson and planning more effectively for future lessons. The questions may be read aloud to the students.

## A

Number Correct: \_\_\_\_\_

## Mixed Division

1.	$4 \div 2 =$	
2.	$6 \div 2 =$	
3.	$10 \div 2 =$	
4.	$20 \div 2 =$	
5.	$10 \div 5 =$	
6.	$15 \div 5 =$	
7.	$25 \div 5 =$	
8.	$20 \div 5 =$	
9.	$8 \div 4 =$	
10.	$12 \div 4 =$	
11.	$20 \div 4 =$	
12.	$16 \div 4 =$	
13.	$6 \div 3 =$	
14.	$9 \div 3 =$	
15.	$15 \div 3 =$	
16.	$12 \div 3 =$	
17.	$60 \div 6 =$	
18.	$12 \div 6 =$	
19.	$18 \div 6 =$	
20.	$35 \div 7 =$	
21.	$14 \div 7 =$	
22.	$21 \div 7 =$	

23.	$16 \div 8 =$	
24.	$40 \div 8 =$	
25.	$32 \div 8 =$	
26.	$56 \div 8 =$	
27.	$18 \div 9 =$	
28.	$45 \div 9 =$	
29.	$36 \div 9 =$	
30.	$63 \div 9 =$	
31.	$64 \div 8 =$	
32.	$48 \div 8 =$	
33.	$81 \div 9 =$	
34.	$54 \div 9 =$	
35.	$24 \div 6 =$	
36.	$16 \div 2 =$	
37.	$28 \div 7 =$	
38.	$27 \div 3 =$	
39.	$24 \div 8 =$	
40.	$32 \div 4 =$	
41.	$27 \div 9 =$	
42.	$72 \div 9 =$	
43.	$56 \div 7 =$	
44.	$72 \div 8 =$	

## B

Number Correct: \_\_\_\_\_

Improvement: \_\_\_\_\_

## Mixed Division

1.	$10 \div 5 =$	
2.	$15 \div 5 =$	
3.	$25 \div 5 =$	
4.	$50 \div 5 =$	
5.	$4 \div 2 =$	
6.	$6 \div 2 =$	
7.	$10 \div 2 =$	
8.	$8 \div 2 =$	
9.	$6 \div 3 =$	
10.	$9 \div 3 =$	
11.	$15 \div 3 =$	
12.	$12 \div 3 =$	
13.	$8 \div 4 =$	
14.	$12 \div 4 =$	
15.	$20 \div 4 =$	
16.	$16 \div 4 =$	
17.	$70 \div 7 =$	
18.	$14 \div 7 =$	
19.	$21 \div 7 =$	
20.	$30 \div 6 =$	
21.	$12 \div 6 =$	
22.	$18 \div 6 =$	

23.	$18 \div 9 =$	
24.	$45 \div 9 =$	
25.	$27 \div 9 =$	
26.	$63 \div 9 =$	
27.	$16 \div 8 =$	
28.	$40 \div 8 =$	
29.	$24 \div 8 =$	
30.	$56 \div 8 =$	
31.	$81 \div 9 =$	
32.	$54 \div 9 =$	
33.	$64 \div 8 =$	
34.	$48 \div 8 =$	
35.	$30 \div 6 =$	
36.	$18 \div 2 =$	
37.	$35 \div 7 =$	
38.	$24 \div 3 =$	
39.	$32 \div 8 =$	
40.	$36 \div 4 =$	
41.	$45 \div 9 =$	
42.	$72 \div 8 =$	
43.	$49 \div 7 =$	
44.	$72 \div 9 =$	

Name \_\_\_\_\_

Date \_\_\_\_\_

List some games we played today in the chart below. Place a check mark in the box that shows how you felt about your level of fluency as you played each activity. Check off the last column if you would like to practice this activity over the summer.

Activity	I still need some practice with my facts.	I am fluent.	I would like to put this in my summer activity book.
1.			
2.			
3.			
4.			
5.			
6.			
7.			
8.			



Name \_\_\_\_\_

Date \_\_\_\_\_

What fluency activity helped you the most in becoming fluent with your multiplication and division facts this year? Write three or four sentences to explain what made it so useful.

Name \_\_\_\_\_ Date \_\_\_\_\_

Teach a family member your favorite fluency game from class. Record information about the game you taught below.

Name of the game: \_\_\_\_\_

\_\_\_\_\_

Materials used: \_\_\_\_\_

\_\_\_\_\_

Name of the person you taught to play: \_\_\_\_\_

Describe what it was like to teach the game. Was it easy? Hard? Why? \_\_\_\_\_

\_\_\_\_\_

\_\_\_\_\_

\_\_\_\_\_

Will you play the game together again? Why or why not? \_\_\_\_\_

\_\_\_\_\_

\_\_\_\_\_

Was the game as fun to play at home as in class? Why or why not? \_\_\_\_\_

\_\_\_\_\_

\_\_\_\_\_

**Multiplication**

Materials: (S) Personal white board

- T: (Draw an array with 3 rows of 2.) Say the repeated addition sentence.  
 S:  $2 + 2 + 2 = 6$ .  
 T: (Write  $3 \times \underline{\quad} = \underline{\quad}$ .) On your personal white board, complete the multiplication sentence.  
 S: (Write  $3 \times 2 = 6$ .)

Repeat using the following ideas: 4 rows of 10, 3 rows of 4, 7 rows of 3, and 8 rows of 2. Or you can think of your own.

**Equal Groups**

Materials: (S) Personal white board

- T: (Draw a picture with 2 groups of 4 circled.) Say the total as a repeated addition sentence.  
 S:  $4 + 4 = 8$ .  
 T: Write a division sentence that means the number of groups is unknown.  
 S: (Write  $8 \div 4 = 2$ .)  
 T: Below that division sentence, write a division sentence that means the number in each group is unknown.  
 S: (Write  $8 \div 2 = 4$ .)

Repeat using the following ideas: 5 groups of 3, 3 groups of 4, and 6 groups of 2. Or you can think of your own.

**Commutative Multiplying**

Materials: (S) Personal white board

- T: (Draw an array with 3 rows of 2 dots.) How many rows of 2 do you see?  
 S: 3 rows of 2.  
 T: Write four different multiplication sentences for the picture.  
 S: (Write  $3 \times 2 = 6$ ,  $2 \times 3 = 6$ ,  $6 = 3 \times 2$ , and  $6 = 2 \times 3$ .)

Repeat using the following ideas: 3 rows of 5 and 4 rows of 3. Or you can think of your own.

- T: (Write  $4 \times 2 = 2 \times \underline{\quad}$ .) On your personal white board, fill in the blank.  
 S: (Write  $4 \times 2 = 2 \times 4$ .)

Repeat using the following ideas:  $9 \times 5 = 5 \times \underline{\quad}$  and  $3 \times 6 = 6 \times \underline{\quad}$ . Or you can think of your own.

**Tape Diagrams**

Materials: (S) Personal white board

- T: (Draw a tape diagram with 5 equal units and 2 stars in the first unit.) What is the value of each unit?  
 S: 2 stars.  
 T: How many units are there?  
 S: 5 units.  
 T: Write a multiplication sentence for this tape diagram.  
 S: (Write  $5 \times 2 = 10$ .)

Repeat using the following ideas:  $4 \times 3 = 12$ ,  $8 \div 4 = 2$ , and  $15 \div 3 = 5$ . Or you can think of your own.

**Tens**

Materials: (S) Place value cards, personal white board

Note: Place value cards can be made with index cards for personal practice.

T: (Write 7 tens = \_\_\_\_.) Say the number.

S: 70.

Repeat using the following ideas: 10 tens, 12 tens, 20 tens, 28 tens, 30 tens, and 37 tens. Or you can think of your own.



Place value cards

**Tens and Hundreds**

Materials: (S) Personal white board

T: (Write  $9 + \underline{\quad} = 10$ .) Say the missing number.

S: 1.

T: (Write  $90 + \underline{\quad} = 100$ .) Say the missing number.

S: 10.

T: (Write  $91 + \underline{\quad} = 100$ .) Say the missing number.

S: 9.

T: (Write  $291 + \underline{\quad} = 300$ .) Say the missing number.

S: 9.

Repeat using the following ideas:

$1 + \underline{\quad} = 10$ ,  $10 + \underline{\quad} = 100$ ,  $11 + \underline{\quad} = 100$ ,  
 $211 + \underline{\quad} = 300$ ,  $8 + \underline{\quad} = 10$ ,  $80 + \underline{\quad} = 100$ ,  
 $85 + \underline{\quad} = 100$ , and  $385 + \underline{\quad} = 400$ .

Or you can think of your own.

**Make Twenty-Four Game**

Materials: (S) Set of 6 cards per pair

Note: Students play in pairs. Each pair has a set of 6 cards, each with a number (2, 3, 4, 6, 8, and 12).

T: (Write  $\underline{\quad} \times \underline{\quad} = 24$ .) Spread the cards out in front of you.

T: Put your hands behind your back. I'll put a number in the first blank. When you know the number that belongs in the second blank, touch the card that shows the number. The first one of us to touch the card keeps it. Whoever has the most cards at the end wins. (Write 12 in the first blank.)

S: (Touch the 2 card. The first to touch it keeps the card.)

Repeat. This time, however, you might make 36 with the same cards plus 9 and 18.

**Write in the Parentheses**

Materials: (S) Personal white board

T: (Write  $10 - 5 + 3 = 8$ .) On your personal white board, copy the equation. Then, insert parentheses to make the statement true.

S: (Write  $(10 - 5) + 3 = 8$ .)

Repeat using the following ideas:

$10 - 5 + 3 = 2$ ,  $10 = 20 - 7 + 3$ ,  $16 = 20 - 7 + 3$ ,  
 $8 + 2 \times 4 = 16$ ,  $8 + 2 \times 4 = 40$ ,  $12 = 12 \div 2 \times 2$ ,  $3 = 12 \div 2 \times 2$ ,  $10 = 35 - 5 \times 5$ , and  $20 - 10 \div 5 = 2$ .

Or you can think of your own.

**Round Three- and Four-Digit Numbers**

Materials: (S) Personal white board

T: (Write  $87 \approx \underline{\quad}$ .) What is 87 rounded to the nearest ten?

S: 90.

Repeat using the following ideas: 97, 43, 643, 35, and 835. Or you can think of your own.

T: (Write  $253 \approx \underline{\quad}$ .) What is 253 rounded to the nearest hundred?

S: 300.

Repeat using the following ideas: 1,253, 735, 1,735, 850, 1,850, 952, 1,371, and 1,450. Or you can think of your own.

**Partition Shapes**

Materials: (S) Personal white board

T: Draw a square.

S: (Draw a square.)

T: (Write  $\frac{1}{2}$ .) Estimate to equally partition the square into halves.

S: (Partition.)

Repeat using the following ideas: line  $\frac{1}{5}$ , circle  $\frac{1}{4}$ , circle  $\frac{1}{8}$ , bar  $\frac{1}{10}$ , and bar  $\frac{1}{6}$ .

Or you can think of your own.

**Write the Unit Fraction**

Materials: (S) Personal white board

T: (Draw a shape with  $\frac{1}{2}$  shaded.) Write the unit fraction.

S: (Write  $\frac{1}{2}$ .)

Repeat using the following ideas:  $\frac{1}{4}$ ,  $\frac{1}{8}$ ,  $\frac{1}{6}$ ,  $\frac{1}{10}$ , and  $\frac{1}{5}$ .

Or you can think of your own.

**Greater or Less Than 1?**

T: (Write  $\frac{1}{2}$ .) Greater or less than 1?

S: Less!

Repeat using the following ideas:  $\frac{3}{2}$ ,  $\frac{5}{4}$ ,  $\frac{3}{4}$ ,  $\frac{3}{7}$ ,  $\frac{5}{3}$ , and  $\frac{5}{2}$ .

Or you can think of your own.

**Draw Fractions from Part to Whole**

Materials: (S) Personal white board

T: Draw 1 unit on your personal white board.

S: (Draw 1 unit.)

T: Label the unit  $\frac{1}{3}$ . Now, draw the whole that goes with your unit of  $\frac{1}{3}$ .

Repeat using the following ideas:  $\frac{1}{5}$ ,  $\frac{1}{6}$ ,  $\frac{1}{4}$ , and  $\frac{1}{2}$ .

Or you can think of your own.

**Draw Number Bonds of One**

Materials: (S) Personal white board

T: Draw a number bond to partition one into halves.

S: (Draw.)

T: How many copies of 1 half did you draw to make one?

S: 2 copies.

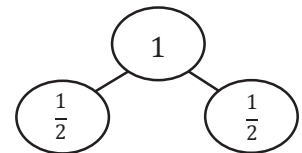

Repeat using the following ideas: thirds, fourths, fifths, sixths, sevenths, etc. Or you can think of your own.

## Lesson 34

Objective: Create resource booklets to support fluency with Grade 3 skills.

### Suggested Lesson Structure

■ Application Problem	(7 minutes)
■ Fluency Practice	(43 minutes)
■ Student Debrief	(10 minutes)
<b>Total Time</b>	<b>(60 minutes)</b>

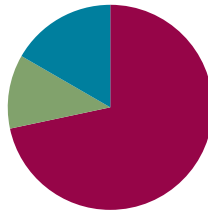

#### NOTES ON RESOURCES INCLUDED IN THIS LESSON:

This lesson includes suggestions and resources for assembling a Summer Practice packet in addition to the resource booklets that students create. Suggestions can be found just before the Student Debrief, and resources are at the end of the lesson.

### Application Problem (7 minutes)

There are 9 bicycles and some tricycles at the repair shop. There are 42 total wheels on all the bicycles and tricycles. How many tricycles are in the shop?

Note: Today's Application Problem challenges students to solve using three out of the four operations. Students may find the total wheels on 9 bicycles mentally. The complexity is to understand that to find the total number of tricycles, they divide the remaining number of wheels by 3.

Solution A

$$2 \times 9 = 18$$

$$42 - 18 = 24$$

$$24 \div 3 = 8$$

There are 8 tricycles in the shop.

Solution B

$$2 \times 9 = 18$$

$$42 - 18 = 24$$

$$3 \times \boxed{8} = 24$$

There are 8 tricycles.

Solution C

$$2 \times 9 = 18$$

$$42 - 18 = 24$$

$$24 \div 3 = 8$$

There are 8 tricycles in the shop.

## Fluency Practice (43 minutes)

- T: Think about all the fluency activities we did this year. Which were your favorites?
- S: (Discuss.)
- T: Which ones helped you improve your fluency with multiplication and division facts? Share with a partner.
- S: Group Counting helped me skip-count forward and backward. That made it simple to use an easy fact to find a hard one. → I worked so hard on my Sprints. They made me get so much faster! → Multiply-By Pattern Sheets were like that for me. → Finding the unknown factor made me get good at thinking of multiplication and division in different ways.
- T: Let's do one last Grade 3 Sprint to celebrate just how far we have come. Then, we will make Summer Practice booklets of our favorite games so we can keep playing at home in the weeks to come.

- Sprint: Multiply and Divide **3.OA.7** (10 minutes)
- Summer Practice Booklet Assembly (10 minutes)
- Mixed Review Fluency Activities (23 minutes)

### Sprint: Multiply and Divide (10 minutes)

Materials: (S) Multiply and Divide Sprint

Note: This Sprint focuses on student mastery of all products and quotients within 100.

### Summer Practice Booklet Assembly (10 minutes)

Materials: (S) 11" × 17" paper (light-colored construction paper or tagboard preferred), scissors, (optional: game directions printouts from Lesson 33 for students to cut out and glue into booklets)

Model for students step by step, as shown in the photos to the right.

- T: Let's make a booklet of practice materials that you can use over the summer. Start with a blank piece of paper. Lay it on your desk so that the long sides of the rectangle are at the top and the bottom.
- S: (Lay the paper on the desks.)



#### NOTES ON MULTIPLE MEANS OF ENGAGEMENT:

To support student participation in the discussion about fluency, consider providing the following scaffolds:

- Present a list of fluency activities students can refer to during the discussion.
- Delineate how to assess improvement. Helpful questions students might ask partners include: "Which fluency activities did you use as you solved problems? Which fluency activities did you share at home or with friends? Were some fluency activities challenging at first but easy later?"

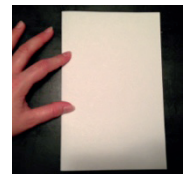
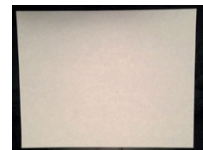

T: Fold the left edge of the paper to meet the right edge. The short sides should be together. Make a tight crease when you fold. The tighter the creases, the better your book will turn out.

S: (Fold the paper.)

T: Keep the paper folded. Again, fold the left edge of the paper to meet the right edge. This time, the long sides should be together. Make a tight crease. You should have a long, skinny rectangle now.

S: (Fold the paper.)

T: Before we unfold, think about what fraction our paper is folded into. Say the fraction at my signal. (Signal.)

S: Fourths.

T: Unfold the paper completely, and lay it out flat.

S: (Unfold the paper.)

T: Now, fold the top edge of the paper down to meet the bottom edge.

S: (Fold the paper.)

T: Now what fraction is the paper folded into?

S: Eighths.

T: Unfold the paper completely, and lay it out flat.

S: (Unfold the paper.)

T: Fold the paper again the same way we first folded it. Make the left edge meet the right edge.

S: (Fold the paper.)

T: Make sure the open side is on the right. Trace the middle fold line halfway across, starting from the left. Do not go past the fold that shows halfway.

S: (Trace.)

T: Now, cut on the line that you just drew. Do not cut past the fold that shows halfway.

S: (Cut.)

T: Please put your scissors away. (This is to prevent students from cutting the edges of the finalized book to even up the pages. If they do that, the book will fall apart because they may cut folds that hold the book together.)

S: (Put away the scissors.)

T: Open up the paper again. You should have cut a slit in the middle of the paper.

S: (Open up the paper.)

T: Fold the top edge to meet the bottom edge so that you have a long rectangle and the slit you cut is at the top of the folded rectangle.

S: (Fold the paper.)





- T: Push the right side of the rectangle toward the left side. Keep going until the pages push together and fall to either side.
- S: (Push the rectangle together to make the booklet.)



- T: Fold the cover over the rest of the pages. Your pages will not line up perfectly, and it is important that you do not trim them with scissors, or your book will fall apart. On the cover of the book, write *Summer Practice* and your name underneath.
- S: (Title the books.)
- T: Pull out the sheet where you recorded your favorite games from yesterday. Work with a partner to write the names of your favorite games and directions for those games in your booklets so that you will remember them later. (Alternatively, print the directions for the games from Lesson 33 for students to cut out their favorites and glue into the booklets.)



Allow time for students to finish the booklets.

### Mixed Review Fluency Activities (23 minutes)

As students finish making booklets, invite them to play the games from Lesson 33 again.

#### Suggested Resources to Include in a Summer Practice Packet

Remind parents that curriculum materials are available for free online.

- Lesson 34 Summer Calendar (included at the end of this lesson)
- 5 Sprints (print, or use extras made during the year)
- 5 Multiply-By Pattern Sheets (print, or use extras made during the year)



#### NOTES ON MULTIPLE MEANS OF ACTION AND EXPRESSION:

Depending on the needs of English language learners, summer packets may be provided in their first languages.

In addition, adjust physical exercises on the summer calendar to suit students' needs. Possible alternatives are listed below:

- Chair push-ups
- Spins and twists
- Clapping, patting, and tapping
- Head nods
- Stretches
- Passive or assisted exercises

**Student Debrief (10 minutes)**

**Lesson Objective:** Create resource booklets to support fluency with Grade 3 skills.

The Student Debrief is intended to invite reflection and active processing of the total lesson experience.

Guide students in a conversation to process the lesson. Any combination of the questions below may be used to lead the discussion.

- What was your favorite math topic in third grade? Why?
- What models or manipulatives helped you with new concepts?
- What was your greatest accomplishment in math this year?
- What are some ways you can keep your math skills sharp during the summer?
- What are you most excited to learn next year as a fourth grader?

## A

Number Correct: \_\_\_\_\_

## Multiply and Divide

1.	$3 \times 2 =$	
2.	$6 \div 2 =$	
3.	$5 \times 3 =$	
4.	$15 \div 5 =$	
5.	$4 \times 2 =$	
6.	$8 \div 4 =$	
7.	$3 \times 3 =$	
8.	$9 \div 3 =$	
9.	$4 \times 3 =$	
10.	$12 \div 4 =$	
11.	$5 \times 5 =$	
12.	$25 \div 5 =$	
13.	$6 \times 2 =$	
14.	$21 \div 7 =$	
15.	$7 \times 4 =$	
16.	$16 \div 8 =$	
17.	$18 \div 3 =$	
18.	$18 \div 9 =$	
19.	$8 \times 3 =$	
20.	$36 \div 9 =$	
21.	$14 \div 7 =$	
22.	$6 \times 4 =$	

23.	$2 \times 7 =$	
24.	$3 \times 8 =$	
25.	$4 \times 9 =$	
26.	$5 \times 7 =$	
27.	$36 \div 6 =$	
28.	$42 \div 7 =$	
29.	$64 \div 8 =$	
30.	$45 \div 9 =$	
31.	$2 \times 8 =$	
32.	$3 \times 9 =$	
33.	$32 \div 4 =$	
34.	$45 \div 5 =$	
35.	$6 \times 7 =$	
36.	$7 \times 7 =$	
37.	$56 \div 8 =$	
38.	$63 \div 9 =$	
39.	$6 \times 6 =$	
40.	$8 \times 8 =$	
41.	$81 \div 9 =$	
42.	$49 \div 7 =$	
43.	$54 \div 6 =$	
44.	$56 \div 7 =$	

## B

Number Correct: \_\_\_\_\_

Improvement: \_\_\_\_\_

## Multiply and Divide

1.	$5 \times 2 =$	
2.	$10 \div 2 =$	
3.	$2 \times 3 =$	
4.	$6 \div 3 =$	
5.	$3 \times 2 =$	
6.	$6 \div 2 =$	
7.	$4 \times 4 =$	
8.	$16 \div 4 =$	
9.	$3 \times 4 =$	
10.	$12 \div 3 =$	
11.	$3 \times 3 =$	
12.	$9 \div 3 =$	
13.	$7 \times 2 =$	
14.	$18 \div 6 =$	
15.	$6 \times 4 =$	
16.	$18 \div 9 =$	
17.	$21 \div 3 =$	
18.	$16 \div 8 =$	
19.	$9 \times 3 =$	
20.	$32 \div 8 =$	
21.	$12 \div 6 =$	
22.	$7 \times 4 =$	

23.	$2 \times 7 =$	
24.	$3 \times 8 =$	
25.	$4 \times 9 =$	
26.	$5 \times 7 =$	
27.	$36 \div 6 =$	
28.	$42 \div 7 =$	
29.	$64 \div 8 =$	
30.	$45 \div 9 =$	
31.	$2 \times 8 =$	
32.	$3 \times 9 =$	
33.	$32 \div 4 =$	
34.	$45 \div 5 =$	
35.	$6 \times 7 =$	
36.	$7 \times 7 =$	
37.	$56 \div 8 =$	
38.	$63 \div 9 =$	
39.	$6 \times 6 =$	
40.	$8 \times 8 =$	
41.	$81 \div 9 =$	
42.	$49 \div 7 =$	
43.	$54 \div 6 =$	
44.	$56 \div 7 =$	

Name \_\_\_\_\_

Date \_\_\_\_\_

Complete a math activity each day. To track your progress, color the box after you finish.

**Summer Math Review: Weeks 1–5**

	<b>Monday</b>	<b>Tuesday</b>	<b>Wednesday</b>	<b>Thursday</b>	<b>Friday</b>
<b>Week 1</b>	Do jumping jacks as you count by twos from 2 to 20 and back.	Play a game from your Summer Practice booklet.	Use your tangram pieces to make a picture of your summer break.	Time how long it takes you to do a specific chore, like making the bed. See if you can do it faster the next day.	Complete a Sprint.
<b>Week 2</b>	Do squats as you count by threes from 3 to 30 and back.	Play a game from your Summer Practice booklet.	Collect data about your family's or friends' favorite type of music. Show it on a bar graph. What did you discover from your graph?	Read a recipe. What fractions does the recipe use?	Complete a Multiply by Pattern Sheet.
<b>Week 3</b>	Hop on one foot as you count by fours from 4 to 40 and back.	Create a multiplication and/or division math game. Then, play the game with a partner.	Measure the widths of different leaves from the same tree to the nearest quarter inch. Then, draw a line plot of your data. Do you notice a pattern?	Read the weight in grams of different food items in your kitchen. Round the weights to the nearest 10 or 100 grams.	Complete a Sprint.
<b>Week 4</b>	Bounce a ball as you count by 5 minutes to 1 hour and then to the half hour and quarter hours.	Find, draw, and/or create different objects to show one-fourth.	Go on a shape scavenger hunt. Find as many quadrilaterals in your neighborhood or house as you can.	Find the sum and difference of 453 mL and 379 mL.	Complete a Multiply by Pattern Sheet.
<b>Week 5</b>	Do arm swings as you count by sixes from 6 to 60 and back.	Draw and label a floor plan of your house.	Measure the perimeter of the room where you sleep in inches. Then, calculate the area.	Use a stopwatch to measure how fast you can run 50 meters. Do it 3 times. What was your fastest time?	Complete a Sprint.

Name \_\_\_\_\_

Date \_\_\_\_\_

Complete a math activity each day. To track your progress, color the box after you finish.

## Summer Math Review: Weeks 6–10

	Monday	Tuesday	Wednesday	Thursday	Friday
Week 6	Alternate counting with a friend or family member by sevens from 7 to 70 and back.	Play a game from your Summer Practice booklet.	Write a story problem for $7 \times 6$ .	Solve $15 \times 4$ . Draw a model to show your thinking.	Complete a Multiply by Pattern Sheet.
Week 7	Jump forward and back as you count by eights from 8 to 80 and back.	Play a game from your Summer Practice booklet.	Use string to measure the perimeter of circular items in your house to the nearest quarter inch.	Build a 4 by 6 array with objects from your house. Write 2 multiplication and 2 division sentences for your array.	Complete a Sprint.
Week 8	Do arm crosses as you count by nines from 9 to 90 and back.  Teach someone the nines finger trick.	Create a multiplication and/or division math game. Then, play the game with a partner.	Write a story problem for $72 \div 8$ .	Measure or find the capacity in milliliters of different liquids in your kitchen. Round each to the nearest 10 or 100 milliliters.	Complete a Multiply by Pattern Sheet.
Week 9	Jump rope as you count up by tens from 280 to 370 and back down.	Find, draw, and/or create different objects to show one-third.	Go on a shape scavenger hunt. Find as many triangles and hexagons in your neighborhood as you can.	Measure the weight of different produce at the grocery store. What unit did you measure in? What are the lightest and heaviest objects you weighed?	Complete a Sprint.
Week 10	Count by sixes starting at 48. Count as high as you can in one minute.	Draw and label a floor plan of your dream tree house.	Find the perimeter of a different room in your house. How much smaller or larger is it compared to the perimeter of the room where you sleep?	Show someone your strategy to solve $8 \times 16$ .	Complete a Multiply by Pattern Sheet.



Answer Key

## **GRADE 3 • MODULE 7**

Geometry and Measurement Word Problems

## Lesson 1

### Pattern Sheet

3	6	9	12
15	3	6	3
9	3	12	3
15	3	6	9
6	12	6	15
6	3	6	9
3	9	6	9
12	9	15	9
12	3	12	6
12	9	12	15
12	15	3	15
6	15	9	15
12	6	12	9
15	9	6	12
9	15	6	12

### Problem Set

- \$22
  - 5
  - 7 minutes
- 4
  - \$4
  - 24

### Exit Ticket

289

### Homework

- \$34
  - 4
  - 7 minutes
- 9
  - \$2
  - 32



## Lesson 2

### Pattern Sheet

3	6	9	12
15	18	21	24
27	30	15	18
15	21	15	24
15	27	15	30
18	15	18	21
18	24	18	27
18	21	18	21
24	21	27	21
24	18	24	21
24	27	27	18
27	21	27	24
27	24	18	27
21	27	18	24
27	21	18	24

### Problem Set

- 8
- 375 milliliters
- 240 square inches
- 3
- 311 grams
- 88 centimeters

### Exit Ticket

40 milliliters

### Homework

- 50 grams
- 7
- 360 square inches
- 4
- 307 grams
- 11 centimeters

## Lesson 3

### Pattern Sheet

4	8	12	16
20	4	8	4
12	4	16	4
20	4	8	12
8	16	8	20
8	4	8	12
4	12	8	12
16	12	20	12
16	4	16	8
16	12	16	20
16	20	4	20
8	20	12	20
16	8	16	12
20	12	8	16
12	20	8	16

### Problem Set

- 9 milliliters
- 102 feet
- 49 grams
- 19 minutes
- 7
- 7 centimeters

### Exit Ticket

72 ounces

### Homework

- 10 milliliters
- 21 minutes
- 120
- a. \$65  
b. \$194
- 6 inches

## Lesson 4

### Pattern Sheet

4	8	12	16
20	24	28	32
36	40	20	24
20	28	20	32
20	36	20	40
24	20	24	28
24	32	24	36
24	28	24	28
32	28	36	28
32	24	32	28
32	36	36	24
36	28	36	32
36	32	24	36
28	36	24	32
36	28	24	32

### Problem Set

- Answer provided  
 A–L; one polygon sketched  
 B, C, E, F, G, H, I, J, L; one polygon sketched  
 B, C, F, G, H, I, L; one polygon sketched  
 B, C, F, H; one polygon sketched  
 C, F; one polygon sketched
- A–L; explanations will vary.
- Polygon sketched and traced; explanations will vary.
- Diagonal line drawn in chart polygons; answers will vary.

**Exit Ticket**

1. 4 equal sides, 2 sets of parallel sides
2. 4 sides, 1 set of parallel sides

**Homework**

1. Answer provided  
True  
True  
False  
True
2. a. Parallel sides traced with a colored pencil  
b. A shape with at least 1 set of parallel sides drawn

## Lesson 5

### Pattern Sheet

5	10	15	20
25	5	10	5
15	5	20	5
25	5	10	15
10	20	10	25
10	5	10	15
5	15	10	15
20	15	25	15
20	5	20	10
20	15	20	25
20	25	5	25
10	25	15	25
20	10	20	15
25	15	10	20
15	25	10	20

### Problem Set

- Answer provided  
M, P, S, U, W; one polygon sketched  
N, O, R, T, Q, V, X; one polygon sketched  
N, Q, T, S; one polygon sketched  
M, N, R, P, S, U, T, X; one polygon sketched
- Answers will vary.
- No; answers will vary.
- U; regular hexagon
  - Drawings will vary.

**Exit Ticket**

1. No; explanations will vary.
2. 2; right angles circled
3. 1
4. Pentagon

**Homework**

1. Hexagon matches *At least 1 right angle* and *All sides are not equal*  
Rectangle matches *At least 1 right angle*, *All sides are not equal*, and *At least 1 set of parallel sides*  
Regular octagon matches *All sides are equal* and *At least 1 set of parallel sides*  
Decagon matches *All sides are not equal*  
Pentagon matches *All sides are not equal*  
Square matches *All sides are equal*, *At least 1 right angle*, and *At least 1 set of parallel sides*
2. Answers will vary.
3. Yes; explanations will vary.

## Lesson 6

### Problem Set

1. Right triangle drawn
2. Square with side lengths of 2 inches drawn
3. Quadrilateral drawn; parallel sides traced in green
4. Pentagon with at least 2 equal sides drawn; equal side lengths labeled
5. Hexagon with at least 2 equal sides drawn; equal side lengths labeled
6. No; explanations and drawings will vary.

### Exit Ticket

Rectangle drawn

### Homework

1. Triangle with no right angles drawn
2. Square, rectangle, or trapezoid drawn
3. Quadrilateral with 2 equal sides drawn; equal side lengths labeled
4. Hexagon with at least 2 equal sides drawn; equal side lengths labeled
5. Pentagon with at least 2 equal sides drawn; equal side lengths labeled
6. Regular triangle with side lengths of 4 cm drawn

## Lesson 7

### Pattern Sheet

5	10	15	20
25	30	35	40
45	50	25	30
25	35	25	40
25	45	25	50
30	25	30	35
30	40	30	45
30	35	30	35
40	35	45	35
40	30	40	35
40	45	45	30
45	35	45	40
45	40	30	45
35	45	30	40
45	35	30	40

### Problem Set

- Grid colored
- Grid colored
  - Number sentence will vary.
  - Number sentence will vary.
- Grid colored
  - Explanations will vary.
- Answers will vary.

### Exit Ticket

Grid colored



**Homework**

1. 3 rectangles colored
2.
  - a. Square with 16 units colored
  - b. 2 rectangles with 24 units colored
3. Explanations will vary.

## Lesson 8

### Pattern Sheet

6	12	18	24
30	6	12	6
18	6	24	6
30	6	12	18
12	24	12	30
12	6	12	18
6	18	12	18
24	18	30	18
24	6	24	12
24	18	24	30
24	30	6	30
12	30	18	30
24	12	24	18
30	18	12	24
18	30	12	24

### Problem Set

- 2 right triangles drawn and labeled
- 2 smaller triangles drawn and labeled
- Trapezoid and triangle drawn and labeled
- 2 smaller trapezoids drawn and labeled
- Square and triangle drawn and labeled
- Parallelogram and triangle drawn and labeled
- Lines drawn correctly inside the square
  - Descriptions and explanations will vary.

### Exit Ticket

3 shapes traced and labeled; one common attribute described

**Homework**

1. Line drawn to divide square
2. Line drawn to divide triangle
3. Line drawn to divide trapezoid
4. Line drawn to divide quadrilateral
5. 4 lines drawn to divide square into 8 equal triangles
6. Descriptions will vary.

## Lesson 9

### Pattern Sheet

6	12	18	24
30	36	42	48
54	60	30	36
30	42	30	48
30	54	30	60
36	30	36	42
36	48	36	54
36	42	36	42
48	42	54	42
48	36	48	42
48	54	54	36
54	42	54	48
54	48	36	54
42	54	36	48
54	42	36	48

### Problem Set

- Drawings will vary.
  - Drawings will vary.
  - Drawings will vary.
  - Drawings will vary.
- Drawings will vary.
- Description of attributes will vary.
- Outlines and descriptions will vary.

### Exit Ticket

Sketches will vary.

**Homework**

1.
  - a. Drawings will vary.
  - b. Drawings will vary.
  - c. Drawings will vary.
  - d. Drawings will vary.
2. Lines are drawn correctly on the cat.
3. Drawings will vary.

## Lesson 10

### Pattern Sheet

7	14	21	28
35	7	14	7
21	7	28	7
35	7	14	21
14	28	14	35
14	7	14	21
7	21	14	21
28	21	35	21
28	7	28	14
28	21	28	35
28	35	7	35
14	35	21	35
28	14	28	21
35	21	14	28
21	35	14	28

### Problem Set

1.
  - a. 2-inch square traced with red crayon
  - b. New shape traced with red crayon
  - c. Answers will vary.
  - d. Shapes colored with blue crayon
  - e. Red; explanations will vary.
  - f. Area; explanations will vary.
  - g. Neither; explanations will vary.
2.
  - a. Perimeters of shapes outlined with red crayon
  - b. Explanations will vary.
3. Paper outlined with highlighter

**Exit Ticket**

1. Outside edges colored purple; inside colored yellow
2. Purple; explanations will vary.

**Homework**

1. Perimeter of each shape traced
  - a. Explanations will vary.
  - b. Explanations will vary.
2. Rectangle drawn on grid
  - a. Perimeter traced
  - b. Area shaded
  - c. Explanations will vary.
3. Maya; explanations will vary.

## Lesson 11

### Problem Set

- Answers will vary.
  - Answers will vary.
  - Answers will vary.
  - Answers will vary.
- Answers will vary.
- Answers will vary.
- Answers will vary.

### Exit Ticket

Drawings will vary.

### Homework

- Shape outlined with highlighter
  - Explanations will vary.
  - 18
  - Shape shaded in with colored pencil
- Drawings will vary.
- Frank; explanations will vary.
- Triangle drawn correctly
  - Yes, explanations will vary.



## Lesson 12

### Pattern Sheet

7	14	21	28
35	42	49	56
63	70	35	42
35	49	35	56
35	63	35	70
42	35	42	49
42	56	42	63
42	49	42	49
56	49	63	49
56	42	56	49
56	63	63	42
63	49	63	56
63	56	42	63
49	63	42	56
63	49	42	56

### Problem Set

- Labeled each side 3 cm; 3, 3, 3, 3; 12
  - Labeled each side 3 cm; 3 cm + 3 cm + 3 cm + 3 cm + 3 cm + 3 cm; 18
  - Labeled each side 4 cm; 4 cm + 4 cm + 4 cm + 4 cm; 16
  - Labeled 6 cm, 6 cm, 5 cm; 6 cm + 6 cm + 5 cm; 17
  - Labeled 3 cm, 3 cm, 2 cm, 3 cm, 1 cm, 6 cm; 3 cm + 3 cm + 2 cm + 3 cm + 1 cm + 6 cm; 18
- Labeled each side 3 cm; Perimeter = 3 cm + 3 cm + 3 cm + 3 cm = 12 cm
- Shapes labeled; Daisy; explanations will vary.
- Explanations will vary; 16 cm

**Exit Ticket**

Labeled 4 cm, 2 cm, 2 cm, 4 cm, 2 cm, 2 cm, 4 cm, 2 cm, 2 cm, 4 cm, 2 cm, 2 cm;  
 $4\text{ cm} + 2\text{ cm} + 2\text{ cm} + 4\text{ cm} + 2\text{ cm} + 2\text{ cm} + 4\text{ cm} + 2\text{ cm} + 2\text{ cm} + 4\text{ cm} + 2\text{ cm} + 2\text{ cm}$ ; 32

**Homework**

1.
  - a. Labeled 3 cm, 4 cm, 5 cm; 3, 4, 5; 12
  - b. Labeled 6 cm, 4 cm, 6 cm, 4 cm;  $6\text{ cm} + 4\text{ cm} + 6\text{ cm} + 4\text{ cm}$ ; 20
  - c. Labeled 3 cm, 4 cm, 5 cm, 4 cm;  $3\text{ cm} + 4\text{ cm} + 5\text{ cm} + 4\text{ cm}$ ; 16
  - d. Labeled each side 5 cm;  $5\text{ cm} + 5\text{ cm} + 5\text{ cm} + 5\text{ cm}$ ; 20
  - e. Labeled 8 cm, 3 cm, 2 cm, 2 cm, 4 cm, 2 cm, 2 cm, 4 cm;  
 $8\text{ cm} + 3\text{ cm} + 2\text{ cm} + 2\text{ cm} + 4\text{ cm} + 2\text{ cm} + 2\text{ cm} + 4\text{ cm}$ ; 27
2. Labeled each side 3 cm; Perimeter =  $3\text{ cm} + 3\text{ cm} + 3\text{ cm} + 3\text{ cm} + 3\text{ cm} + 3\text{ cm} = 18\text{ cm}$
3. No; explanations will vary.
4. No; explanations will vary.

## Lesson 13

### Pattern Sheet

8	16	24	32
40	8	16	8
24	8	32	8
40	8	16	24
16	32	16	40
16	8	16	24
8	24	16	24
32	24	40	24
32	8	32	16
32	24	32	40
32	40	8	40
16	40	24	40
32	16	32	24
40	24	16	32
24	40	16	32

### Problem Set

- 22
  - 4, 4, 4, 4; 16
  - 11, 9, 6; 26
  - 15, 5, 9, 7; 36
  - 9, 9, 2, 2, 3; 25
- 52 m
- 24 in
  - Yes; 5 sides

### Exit Ticket

Shape B; explanations will vary.

**Homework**

1. Shape q: Answer provided  
Shape r:  $P = 6 \text{ ft} + 9 \text{ ft} + 6 \text{ ft} + 6 \text{ ft} + 9 \text{ ft}$ ;  $P = 36 \text{ ft}$   
Shape s:  $P = 7 \text{ cm} + 5 \text{ cm} + 7 \text{ cm} + 5 \text{ cm}$ ;  $P = 24 \text{ cm}$   
Shape a:  $P = 9 \text{ yd} + 7 \text{ yd} + 5 \text{ yd} + 7 \text{ yd}$ ;  $P = 28 \text{ yd}$   
Shape m:  $P = 4 \text{ in} + 4 \text{ in} + 4 \text{ in} + 4 \text{ in}$ ;  $P = 16 \text{ in}$   
Shape e:  $P = 8 \text{ cm} + 5 \text{ cm} + 8 \text{ cm} + 5 \text{ cm}$ ;  $P = 26 \text{ cm}$   
Shape u:  $P = 6 \text{ m} + 3 \text{ m} + 7 \text{ m} + 4 \text{ m}$ ;  $P = 20 \text{ m}$   
Shape l:  $P = 4 \text{ m} + 3 \text{ m} + 4 \text{ m} + 2 \text{ m} + 2 \text{ m}$ ;  $P = 15 \text{ m}$   
Square meals
2. 160 ft
3. a. 33 in  
b. Yes; 8 sides

## Lesson 14

### Pattern Sheet

8	16	24	32
40	48	56	64
72	80	40	48
40	56	40	64
40	72	40	80
48	40	48	56
48	64	48	72
48	56	48	56
64	56	72	56
64	48	64	56
64	72	72	48
72	56	72	64
72	64	48	72
56	72	48	64
72	56	48	64

### Problem Set

- Labeled each side 8 in; 56
  - Labeled each side 7 ft; 21
  - Labeled each side 9 m; 36
  - Labeled each side 6 in; 30
- Labeled 7 cm and 2 cm; 18
- 48 cm
- 34 in
- Both; explanations will vary.

**Exit Ticket**

Regular pentagon; work shown correctly

**Homework**

1.
  - a. Labeled each side 4 in; 12
  - b. Labeled each side 8 cm; 32
  - c. Labeled each side 9 m; 72
  - d. Labeled each side 6 in; 36
2. Labeled 4 cm and 9 cm; 26
3. 35 cm
4. 96 m
5. 38 in

## Lesson 15

### Pattern Sheet

9	18	27	36
45	9	18	9
27	9	36	9
45	9	18	27
18	36	18	45
18	9	18	27
9	27	18	27
36	27	45	27
36	9	36	18
36	27	36	45
36	45	9	45
18	45	27	45
36	18	36	27
45	27	18	36
27	45	18	36

### Problem Set

- 22 ft
- 165 cm
- 34 yd
- 180 in
- 640 yd
- 216 in

### Exit Ticket

36 yd

### Homework

- 26 in
- 40 ft
- 160 yd
- 36 in
- 64 ft
- 32 ft

## Lesson 16

### Pattern Sheet

9	18	27	36
45	54	63	72
81	90	45	54
45	63	45	72
45	81	45	90
54	45	54	63
54	72	54	81
54	63	54	63
72	63	81	63
72	54	72	63
72	81	81	54
81	63	81	72
81	72	54	81
63	81	54	72
81	63	54	72

### Problem Set

- Answers will vary.
  - Explanations will vary.
  - Yes, explanations will vary.
- No; explanations will vary.
- No; explanations will vary.
- No; explanations will vary.

### Exit Ticket

Answers will vary.



**Homework**

1.
  - a. Answers will vary.
  - b. Explanations will vary.
2. Shape A: 8 in; Shape B:  $8\frac{3}{4}$  in
  - a. Shape B
  - b. About 1 in; answers may vary.
3. Answers will vary.

## Lesson 17

### Problem Set

- Labeled 1 cm, 2 cm;  $P = (3 \times 2 \text{ cm}) + 1 \text{ cm} + 3 \text{ cm} + 4 \text{ cm} = 14 \text{ cm}$  (equations may vary)
  - Labeled 1 ft, 1 ft, 2 ft;  $P = (4 \times 2 \text{ ft}) + (3 \times 1 \text{ ft}) + 5 \text{ ft} = 16 \text{ ft}$  (equations may vary)
  - Labeled 2 m, 2 m, 4 m;  $P = (5 \times 2 \text{ m}) + (2 \times 4 \text{ m}) + 6 \text{ m} = 24 \text{ m}$  (equations may vary)
  - Labeled 2 yd, 1 yd, 2 yd;  $P = (7 \times 2 \text{ yd}) + 7 \text{ yd} + 1 \text{ yd} + 4 \text{ yd} = 26 \text{ yd}$  (equations may vary)
- 48 cm
- $a = 8 \text{ in}$ ,  $b = 5 \text{ in}$ ; 26 in

### Exit Ticket

$a = 7 \text{ m}$ ,  $b = 8 \text{ m}$ ; 30 m

### Homework

- Labeled 3 m, 7 m;  $P = (2 \times 7 \text{ m}) + 3 \text{ m} + 2 \text{ m} + 9 \text{ m} + 4 \text{ m} = 32 \text{ m}$  (equations may vary)
  - Labeled 4 cm;  $P = (2 \times 2 \text{ cm}) + (2 \times 4 \text{ cm}) + 3 \text{ cm} + 5 \text{ cm} + 6 \text{ cm} + 8 \text{ cm} = 34 \text{ cm}$  (equations may vary)
  - Labeled 2 in, 6 in, 4 in;  $P = (2 \times 2 \text{ in}) + (3 \times 4 \text{ in}) + (2 \times 6 \text{ in}) + 12 \text{ in} = 40 \text{ in}$  (equations may vary)
  - Labeled 3 ft, 3 ft;  $P = (4 \times 3 \text{ ft}) + 1 \text{ ft} + 2 \text{ ft} + 7 \text{ ft} + 8 \text{ ft} = 30 \text{ ft}$  (equations may vary)
- 72 cm
- $a = 13 \text{ in}$ ,  $b = 6 \text{ in}$ ; 38 in

## Lesson 18

### Problem Set

- 4 rectangles drawn and labeled correctly; perimeters calculated correctly
  - Answers will vary.
- 3 rectangles drawn and labeled correctly
  - 16 units, explanations will vary.
- Yes; explanations will vary.

### Exit Ticket

- 1; 26 cm  
4; 14 cm  
2; 16 cm

### Homework

- 3 rectangles shaded correctly on the grid
- Answers will vary.
- 3 rectangles drawn with side lengths labeled correctly
  - The  $1 \times 20$  rectangle will have the greatest perimeter. Explanations will vary.
  - The  $4 \times 5$  rectangle will have the smallest perimeter. Explanations will vary.

## Lesson 19

### Problem Set

- 1, 1, 13; 2, 1, 14, 2, 7; 2, 1, 15, 3, 5; 3, 1, 16, 2, 8, 4, 4; 1, 1, 17; 3, 1, 18, 2, 9, 3, 6
- Line plot created
- 12, 16, and 18 unit squares
- Answers will vary.

### Exit Ticket

3, 1, 20, 2, 10, 4, 5

### Homework

- 2, 1, 6, 2, 3; 1, 1, 7; 2, 1, 8, 2, 4; 2, 1, 9, 3, 3; 2, 1, 10, 2, 5; 1, 1, 11
- Line plot created
  - No; explanations will vary.
  - 2; explanations will vary.

## Lesson 20

### Sprint

#### Side A

- |        |        |        |        |
|--------|--------|--------|--------|
| 1. 4   | 12. 14 | 23. 10 | 34. 8  |
| 2. 6   | 13. 16 | 24. 2  | 35. 7  |
| 3. 8   | 14. 18 | 25. 3  | 36. 9  |
| 4. 10  | 15. 20 | 26. 10 | 37. 6  |
| 5. 2   | 16. 8  | 27. 5  | 38. 8  |
| 6. 2   | 17. 7  | 28. 2  | 39. 22 |
| 7. 3   | 18. 9  | 29. 2  | 40. 11 |
| 8. 5   | 19. 6  | 30. 3  | 41. 24 |
| 9. 2   | 20. 10 | 31. 6  | 42. 12 |
| 10. 4  | 21. 5  | 32. 7  | 43. 28 |
| 11. 12 | 22. 6  | 33. 9  | 44. 14 |

#### Side B

- |        |        |        |        |
|--------|--------|--------|--------|
| 1. 2   | 12. 12 | 23. 2  | 34. 7  |
| 2. 4   | 13. 14 | 24. 10 | 35. 8  |
| 3. 6   | 14. 16 | 25. 3  | 36. 9  |
| 4. 8   | 15. 18 | 26. 2  | 37. 6  |
| 5. 10  | 16. 7  | 27. 2  | 38. 7  |
| 6. 3   | 17. 6  | 28. 10 | 39. 22 |
| 7. 2   | 18. 8  | 29. 5  | 40. 11 |
| 8. 4   | 19. 10 | 30. 3  | 41. 24 |
| 9. 2   | 20. 9  | 31. 6  | 42. 12 |
| 10. 5  | 21. 6  | 32. 8  | 43. 26 |
| 11. 20 | 22. 5  | 33. 9  | 44. 13 |

**Problem Set**

1.
  - a. 3 rectangles drawn and labeled
  - b. Answers will vary.
  - c. 6 square units, 8 square units, 9 square units
  - d. Areas are different
2.
  - a. 3 rectangles drawn and labeled
  - b. 6 square units, 10 square units, 12 square units
  - c. Answers will vary.

**Exit Ticket**

- a. 2 rectangles are drawn and labeled
- b. 3 square units, 4 square units

**Homework**

1.
  - a. 2 rectangles drawn and labeled
  - b. 4 square units, 6 square units
2. Yes; explanations will vary.
3.
  - a. 5 cm by 5 cm square drawn and labeled
  - b. 25 sq cm
  - c. Different rectangle drawn
  - d. Katie's square

## Lesson 21

### Sprint

#### Side A

- |        |        |        |        |
|--------|--------|--------|--------|
| 1. 6   | 12. 21 | 23. 10 | 34. 8  |
| 2. 9   | 13. 24 | 24. 2  | 35. 7  |
| 3. 12  | 14. 27 | 25. 3  | 36. 9  |
| 4. 15  | 15. 30 | 26. 10 | 37. 6  |
| 5. 3   | 16. 8  | 27. 5  | 38. 8  |
| 6. 2   | 17. 7  | 28. 1  | 39. 33 |
| 7. 3   | 18. 9  | 29. 2  | 40. 11 |
| 8. 5   | 19. 6  | 30. 3  | 41. 36 |
| 9. 1   | 20. 10 | 31. 6  | 42. 12 |
| 10. 4  | 21. 5  | 32. 7  | 43. 39 |
| 11. 18 | 22. 1  | 33. 9  | 44. 13 |

#### Side B

- |        |        |        |        |
|--------|--------|--------|--------|
| 1. 3   | 12. 18 | 23. 2  | 34. 7  |
| 2. 6   | 13. 21 | 24. 10 | 35. 8  |
| 3. 9   | 14. 24 | 25. 3  | 36. 9  |
| 4. 12  | 15. 27 | 26. 2  | 37. 6  |
| 5. 15  | 16. 7  | 27. 1  | 38. 7  |
| 6. 3   | 17. 6  | 28. 10 | 39. 33 |
| 7. 2   | 18. 8  | 29. 5  | 40. 11 |
| 8. 4   | 19. 10 | 30. 3  | 41. 36 |
| 9. 1   | 20. 9  | 31. 6  | 42. 12 |
| 10. 5  | 21. 1  | 32. 8  | 43. 39 |
| 11. 30 | 22. 5  | 33. 9  | 44. 13 |

**Problem Set**

1.
  - a. 4 rectangles sketched and labeled
  - b. 7 sq cm, 12 sq cm, 15 sq cm, 16 sq cm
2.
  - a. 4 rectangles sketched and labeled
  - b. 8 sq cm, 14 sq cm, 18 sq cm, 20 sq cm
3.
  - a. 2, 2 cm, 3 cm, 6 sq cm  
5, 2 cm, 8 cm, 16 sq cm; 3 cm 7 cm, 21 sq cm; 4 cm, 6 cm, 24 sq cm; 5 cm, 5 cm, 25 sq cm
  - b. Yes, explanations will vary.
4. Answers will vary.

**Exit Ticket**

Answers will vary.

**Homework**

1.
  - a. 3 rectangles shaded and labeled
  - b. 6 sq cm, 10 sq cm, 12 sq cm
  - c. Answers will vary.
2.
  - a. 4, 2 units, 7 units, 14 sq units; 3 units, 6 units, 18 sq units; 4 units, 5 units, 20 sq units
  - b. Explanations will vary.
3. Answers will vary.



## Lesson 22

### Sprint

#### Side A

- |        |        |        |        |
|--------|--------|--------|--------|
| 1. 8   | 12. 28 | 23. 10 | 34. 8  |
| 2. 12  | 13. 32 | 24. 2  | 35. 7  |
| 3. 16  | 14. 36 | 25. 3  | 36. 9  |
| 4. 20  | 15. 40 | 26. 10 | 37. 6  |
| 5. 4   | 16. 8  | 27. 5  | 38. 8  |
| 6. 2   | 17. 7  | 28. 1  | 39. 44 |
| 7. 3   | 18. 9  | 29. 2  | 40. 11 |
| 8. 5   | 19. 6  | 30. 3  | 41. 3  |
| 9. 1   | 20. 10 | 31. 6  | 42. 12 |
| 10. 4  | 21. 5  | 32. 7  | 43. 56 |
| 11. 24 | 22. 1  | 33. 9  | 44. 14 |

#### Side B

- |        |        |        |        |
|--------|--------|--------|--------|
| 1. 4   | 12. 24 | 23. 2  | 34. 7  |
| 2. 8   | 13. 28 | 24. 10 | 35. 8  |
| 3. 12  | 14. 32 | 25. 3  | 36. 9  |
| 4. 16  | 15. 36 | 26. 2  | 37. 6  |
| 5. 20  | 16. 7  | 27. 1  | 38. 7  |
| 6. 3   | 17. 6  | 28. 10 | 39. 44 |
| 7. 2   | 18. 8  | 29. 5  | 40. 11 |
| 8. 4   | 19. 10 | 30. 3  | 41. 48 |
| 9. 1   | 20. 9  | 31. 3  | 42. 12 |
| 10. 5  | 21. 1  | 32. 4  | 43. 52 |
| 11. 40 | 22. 5  | 33. 9  | 44. 13 |

**Problem Set**

1. Line plot created
2. Answers will vary.
3. No
4. No; explanations will vary.
5. Explanations will vary.

**Exit Ticket**

Answers will vary.

**Homework**

1.
  - a. Explanations will vary; no
  - b. Explanations will vary; whole number side lengths
  - c. 8; explanations will vary.
2. No; explanations will vary.
3. Explanations will vary.

## Lesson 23

### Sprint

#### Side A

- |        |        |        |        |
|--------|--------|--------|--------|
| 1. 10  | 12. 35 | 23. 10 | 34. 8  |
| 2. 15  | 13. 40 | 24. 2  | 35. 7  |
| 3. 20  | 14. 45 | 25. 3  | 36. 9  |
| 4. 25  | 15. 50 | 26. 10 | 37. 6  |
| 5. 5   | 16. 8  | 27. 5  | 38. 8  |
| 6. 2   | 17. 7  | 28. 1  | 39. 55 |
| 7. 3   | 18. 9  | 29. 2  | 40. 11 |
| 8. 5   | 19. 6  | 30. 3  | 41. 3  |
| 9. 1   | 20. 10 | 31. 6  | 42. 12 |
| 10. 4  | 21. 5  | 32. 7  | 43. 60 |
| 11. 30 | 22. 1  | 33. 9  | 44. 14 |

#### Side B

- |        |        |        |        |
|--------|--------|--------|--------|
| 1. 5   | 12. 30 | 23. 2  | 34. 7  |
| 2. 10  | 13. 35 | 24. 10 | 35. 8  |
| 3. 15  | 14. 40 | 25. 3  | 36. 9  |
| 4. 20  | 15. 45 | 26. 2  | 37. 6  |
| 5. 25  | 16. 7  | 27. 1  | 38. 7  |
| 6. 3   | 17. 6  | 28. 10 | 39. 55 |
| 7. 2   | 18. 8  | 29. 5  | 40. 11 |
| 8. 4   | 19. 10 | 30. 3  | 41. 60 |
| 9. 1   | 20. 9  | 31. 3  | 42. 12 |
| 10. 5  | 21. 1  | 32. 4  | 43. 65 |
| 11. 50 | 22. 5  | 33. 9  | 44. 13 |

**Problem Set**

1. 6 cm
2. 184 in
3. 8 ft
4. 96 in
5. \$40
6. Yes

**Exit Ticket**

9 cm

**Homework**

1. 9 in
2. 144 in
3. 250 ft
4. 99 in
5. 24 in
6. 76 in

## Lesson 24

### Pattern Sheet

6	12	18	24
30	36	42	48
54	60	30	36
30	42	30	48
30	54	30	60
36	30	36	42
36	48	36	54
36	42	36	42
48	42	54	42
48	36	48	42
48	54	54	36
54	42	54	48
54	48	36	54
42	54	36	48
54	42	36	48

### Problem Set

- |  |   |
|--|---|
| A. Width and length will vary.                 | J. Estimated and measured with string     |
| B. Width and length will vary.                 | K. Width and length will vary.            |
| C. Width and length will vary.                 | L. Estimated and measured with string     |
| D. Width and length will vary.                 | M. Width and length will vary.            |
| E. 28; width and length will vary.             | N. Estimated and measured with string     |
| F. Width and length will vary.                 | O. Width and length will vary.            |
| G. 8; width and length will vary.              | P. Extra items and information will vary. |
| H. Extra body parts and information will vary. | Q. Extra items and information will vary. |
| I. Extra body parts and information will vary. |   |

## Exit Ticket

Answers will vary.

## Homework

1. 6 in
2.
  - a. 8 cm by 1 cm  
7 cm by 2 cm  
6 cm by 3 cm  
5 cm by 4 cm
  - b. 4 rectangles
  - c. Explanations will vary.
3.
  - a. 1 cm by 2 cm  
1 cm by 4 cm or 2 cm by 3 cm  
1 cm by 6 cm, 2 cm by 5 cm, or 3 cm by 4 cm
  - b. 1 cm by 5 cm, 2 cm by 4 cm, or 3 cm by 3 cm  
P = 20 cm; 1 cm by 9 cm, 2 cm by 8 cm, 3 cm by 7 cm, 4 cm by 6 cm, or 5 cm by 5 cm  
P = 28 cm; 1 cm by 13 cm, 2 cm by 12 cm, 3 cm by 11 cm, 4 cm by 10 cm, 5 cm by 9 cm, 6 cm by 8 cm, or 7 cm by 7 cm

## Lesson 25

### Sprint

#### Side A

- |        |        |        |        |
|--------|--------|--------|--------|
| 1. 12  | 12. 42 | 23. 10 | 34. 8  |
| 2. 18  | 13. 48 | 24. 2  | 35. 7  |
| 3. 24  | 14. 54 | 25. 3  | 36. 9  |
| 4. 30  | 15. 60 | 26. 10 | 37. 6  |
| 5. 6   | 16. 8  | 27. 5  | 38. 8  |
| 6. 2   | 17. 7  | 28. 1  | 39. 66 |
| 7. 3   | 18. 9  | 29. 2  | 40. 11 |
| 8. 5   | 19. 6  | 30. 3  | 41. 72 |
| 9. 1   | 20. 10 | 31. 6  | 42. 12 |
| 10. 4  | 21. 5  | 32. 7  | 43. 84 |
| 11. 36 | 22. 1  | 33. 9  | 44. 14 |

#### Side B

- |        |        |        |        |
|--------|--------|--------|--------|
| 1. 6   | 12. 36 | 23. 2  | 34. 7  |
| 2. 12  | 13. 42 | 24. 10 | 35. 8  |
| 3. 18  | 14. 48 | 25. 3  | 36. 9  |
| 4. 24  | 15. 54 | 26. 2  | 37. 6  |
| 5. 30  | 16. 7  | 27. 1  | 38. 7  |
| 6. 3   | 17. 6  | 28. 10 | 39. 66 |
| 7. 2   | 18. 8  | 29. 5  | 40. 11 |
| 8. 4   | 19. 10 | 30. 3  | 41. 72 |
| 9. 1   | 20. 9  | 31. 3  | 42. 12 |
| 10. 5  | 21. 1  | 32. 4  | 43. 78 |
| 11. 60 | 22. 5  | 33. 9  | 44. 13 |

**Problem Set**

Pictures and labels will vary.

**Exit Ticket**

- Answers will vary.
  - Answers will vary.
- Answers will vary.

**Homework**

- Answer provided
- $P = 4 \times 2 \text{ cm}$ , or  $P = 2 \text{ cm} + 2 \text{ cm} + 2 \text{ cm} + 2 \text{ cm}$   
 $P = 8 \text{ cm}$
- $P = 8 \text{ cm} + 6 \text{ cm} + 8 \text{ cm} + 6 \text{ cm}$   
 $P = 28 \text{ cm}$
- $P = 2 \text{ cm} + 5 \text{ cm} + 2 \text{ cm} + 5 \text{ cm}$   
 $P = 14 \text{ cm}$
- $P = 2 \text{ cm} + 5 \text{ cm} + 2 \text{ cm} + 5 \text{ cm}$   
 $P = 14 \text{ cm}$
- $P = 7 \text{ cm} + 2 \text{ cm} + 7 \text{ cm} + 2 \text{ cm}$   
 $P = 18 \text{ cm}$
- $P = 7 \text{ cm} + 2 \text{ cm} + 7 \text{ cm} + 2 \text{ cm}$   
 $P = 18 \text{ cm}$



## Lesson 26

### Pattern Sheet

7	14	21	28
35	42	49	56
63	70	35	42
35	49	35	56
35	63	35	70
42	35	42	49
42	56	42	63
42	49	42	49
56	49	63	49
56	42	56	49
56	63	63	42
63	49	63	56
63	56	42	63
49	63	42	56
63	49	42	56

### Problem Set

- Answers will vary.
  - Answers will vary.
- Answers will vary.
- Explanations will vary.
- Answers will vary.

### Exit Ticket

- Answers will vary.
- Answers will vary.

**Homework**

1.
  - a. 16 cm
  - b. 16 cm
  - c. 16 sq cm
  - d. 15 sq cm
  - e. Explanations will vary.
2.
  - a. Answers will vary.
  - b. Yes; explanations will vary.
  - c. 4 cm by 10 cm

## Lesson 27

### Sprint

#### Side A

- |        |        |        |        |
|--------|--------|--------|--------|
| 1. 14  | 12. 49 | 23. 10 | 34. 8  |
| 2. 21  | 13. 56 | 24. 2  | 35. 7  |
| 3. 28  | 14. 63 | 25. 3  | 36. 9  |
| 4. 35  | 15. 70 | 26. 10 | 37. 6  |
| 5. 7   | 16. 8  | 27. 5  | 38. 8  |
| 6. 2   | 17. 7  | 28. 1  | 39. 77 |
| 7. 3   | 18. 9  | 29. 2  | 40. 11 |
| 8. 5   | 19. 6  | 30. 3  | 41. 84 |
| 9. 1   | 20. 10 | 31. 6  | 42. 12 |
| 10. 4  | 21. 5  | 32. 7  | 43. 98 |
| 11. 42 | 22. 1  | 33. 9  | 44. 14 |

#### Side B

- |        |        |        |        |
|--------|--------|--------|--------|
| 1. 7   | 12. 42 | 23. 2  | 34. 7  |
| 2. 14  | 13. 49 | 24. 10 | 35. 8  |
| 3. 21  | 14. 56 | 25. 3  | 36. 9  |
| 4. 28  | 15. 63 | 26. 2  | 37. 6  |
| 5. 35  | 16. 7  | 27. 1  | 38. 7  |
| 6. 3   | 17. 6  | 28. 10 | 39. 77 |
| 7. 2   | 18. 8  | 29. 5  | 40. 11 |
| 8. 4   | 19. 10 | 30. 3  | 41. 84 |
| 9. 1   | 20. 9  | 31. 3  | 42. 12 |
| 10. 5  | 21. 1  | 32. 4  | 43. 91 |
| 11. 70 | 22. 5  | 33. 9  | 44. 13 |

**Problem Set****Part A**

1. Evaluations will vary.
2. Answers and calculations will vary.
3. Answers and calculations will vary.

**Part B**

4. Evaluations will vary.

**Exit Ticket**

1. Rectangle A: 5, 5; 20 cm; 25 sq cm  
Rectangle B: 8, 2; 20 cm; 16 sq cm
2. Answers will vary.

**Homework**

1. Rectangle A: 6, 6; 24 cm; 36 sq cm  
Rectangle B: 4, 8; 24 cm; 32 sq cm  
Rectangle C: 11, 1; 24 cm; 11 sq cm  
Rectangle D: 5, 5; 20 cm; 25 sq cm  
Rectangle E: 2, 8; 20 cm; 16 sq cm  
Rectangle F: 4, 6; 20 cm; 24 sq cm
2. Answers will vary.
3. Answers will vary.
4. A, D; A

## Lesson 28

### Pattern Sheet

8	16	24	32
40	48	56	64
72	80	40	48
40	56	40	64
40	72	40	80
48	40	48	56
48	64	48	72
48	56	48	56
64	56	72	56
64	48	64	56
64	72	72	48
72	56	72	64
72	64	48	72
56	72	48	64
72	56	48	64

**Problem Set**

1.
  - a. 7 yd by 9 yd rectangle drawn and labeled correctly
  - b. 63 sq yd
  - c. 32 yd
2.
  - a. 8 cm by 8 cm square drawn and labeled correctly
  - b. 64 sq cm
  - c. 32 cm
  - d. 64 cm
3.
  - a. Drawings will vary.
  - b. 9 in
  - c. 34 in
  - d. 217 sq in
4.
  - a. Drawings will vary.
  - b. 8 ft
  - c. 72 sq ft
  - d. 48 sq ft

**Exit Ticket**

- a. 6 ft by 8 ft rectangle drawn and labeled correctly
- b. 48 sq ft
- c. 28 ft

**Homework**

1.
  - a. 7 cm by 7 cm square drawn and labeled correctly
  - b. 49 sq cm
  - c. 28 cm
  - d. 42 cm
2.
  - a. Drawings will vary.
  - b. 6 ft
  - c. 18 sq ft
  - d. 54 sq ft

## Lesson 29

### Sprint

#### Side A

- |        |        |        |         |
|--------|--------|--------|---------|
| 1. 16  | 12. 56 | 23. 10 | 34. 8   |
| 2. 24  | 13. 64 | 24. 2  | 35. 7   |
| 3. 32  | 14. 72 | 25. 3  | 36. 9   |
| 4. 40  | 15. 80 | 26. 10 | 37. 6   |
| 5. 8   | 16. 8  | 27. 5  | 38. 8   |
| 6. 2   | 17. 7  | 28. 1  | 39. 88  |
| 7. 3   | 18. 9  | 29. 2  | 40. 11  |
| 8. 5   | 19. 6  | 30. 3  | 41. 96  |
| 9. 1   | 20. 10 | 31. 6  | 42. 12  |
| 10. 4  | 21. 5  | 32. 7  | 43. 112 |
| 11. 48 | 22. 1  | 33. 9  | 44. 14  |

#### Side B

- |        |        |        |         |
|--------|--------|--------|---------|
| 1. 8   | 12. 48 | 23. 2  | 34. 7   |
| 2. 16  | 13. 56 | 24. 10 | 35. 8   |
| 3. 24  | 14. 64 | 25. 3  | 36. 9   |
| 4. 32  | 15. 72 | 26. 2  | 37. 6   |
| 5. 40  | 16. 7  | 27. 1  | 38. 7   |
| 6. 3   | 17. 1  | 28. 10 | 39. 88  |
| 7. 2   | 18. 8  | 29. 5  | 40. 11  |
| 8. 4   | 19. 10 | 30. 3  | 41. 96  |
| 9. 1   | 20. 9  | 31. 3  | 42. 12  |
| 10. 5  | 21. 1  | 32. 4  | 43. 104 |
| 11. 80 | 22. 5  | 33. 9  | 44. 13  |

**Problem Set**

1.
  - a. 56 in
  - b. 144 sq in
  - c. 72 in
2. 25 ft
3. 36 cm
4. 700 yd

**Exit Ticket**

64 cm

**Homework**

1.
  - a. 48 in
  - b. 128 sq in
  - c. 256 sq in
2.
  - a. 36 cm
  - b. 72 sq cm
3. 800 yd



## Lesson 30

### Pattern Sheet

9	18	27	36
45	54	63	72
81	90	45	54
45	63	45	72
45	81	45	90
54	45	54	63
54	72	54	81
54	63	54	63
72	63	81	63
72	54	72	63
72	81	81	54
81	63	81	72
81	72	54	81
63	81	54	72
81	63	54	72

### Problem Set

Answers will vary.

### Exit Ticket

1. Answers will vary.
2. Answers will vary.

### Homework

Answers will vary.

## Lesson 31

### Sprint

#### Side A

- |        |        |        |         |
|--------|--------|--------|---------|
| 1. 18  | 12. 63 | 23. 10 | 34. 8   |
| 2. 27  | 13. 72 | 24. 2  | 35. 7   |
| 3. 36  | 14. 81 | 25. 3  | 36. 9   |
| 4. 45  | 15. 90 | 26. 10 | 37. 6   |
| 5. 9   | 16. 8  | 27. 5  | 38. 8   |
| 6. 2   | 17. 7  | 28. 1  | 39. 99  |
| 7. 3   | 18. 9  | 29. 2  | 40. 11  |
| 8. 5   | 19. 6  | 30. 3  | 41. 108 |
| 9. 1   | 20. 10 | 31. 6  | 42. 12  |
| 10. 4  | 21. 5  | 32. 7  | 43. 126 |
| 11. 54 | 22. 1  | 33. 9  | 44. 14  |

#### Side B

- |        |        |        |         |
|--------|--------|--------|---------|
| 1. 9   | 12. 54 | 23. 2  | 34. 7   |
| 2. 18  | 13. 63 | 24. 10 | 35. 8   |
| 3. 27  | 14. 72 | 25. 3  | 36. 9   |
| 4. 36  | 15. 81 | 26. 2  | 37. 6   |
| 5. 45  | 16. 7  | 27. 1  | 38. 7   |
| 6. 3   | 17. 6  | 28. 10 | 39. 99  |
| 7. 2   | 18. 8  | 29. 5  | 40. 11  |
| 8. 4   | 19. 10 | 30. 3  | 41. 108 |
| 9. 1   | 20. 9  | 31. 3  | 42. 12  |
| 10. 5  | 21. 1  | 32. 4  | 43. 117 |
| 11. 90 | 22. 5  | 33. 9  | 44. 13  |

**Problem Set**

Answers will vary.

**Exit Ticket**

Answers will vary.

**Homework**

1.
  - a. 18 square units
  - b. 9 square units
  - c. Half of the rectangle shaded
  - d. Answers will vary.
2. Explanations will vary.
3. Answers will vary.

## Lesson 32

### Sprint

#### Side A

- |        |        |        |        |
|--------|--------|--------|--------|
| 1. 2   | 12. 6  | 23. 14 | 34. 16 |
| 2. 4   | 13. 9  | 24. 25 | 35. 18 |
| 3. 6   | 14. 5  | 25. 30 | 36. 35 |
| 4. 4   | 15. 10 | 26. 35 | 37. 40 |
| 5. 8   | 16. 15 | 27. 20 | 38. 45 |
| 6. 12  | 17. 7  | 28. 24 | 39. 28 |
| 7. 6   | 18. 14 | 29. 28 | 40. 32 |
| 8. 12  | 19. 9  | 30. 15 | 41. 36 |
| 9. 8   | 20. 18 | 31. 18 | 42. 21 |
| 10. 16 | 21. 10 | 32. 21 | 43. 24 |
| 11. 3  | 22. 12 | 33. 14 | 44. 27 |

#### Side B

- |        |        |        |        |
|--------|--------|--------|--------|
| 1. 5   | 12. 4  | 23. 35 | 34. 40 |
| 2. 10  | 13. 6  | 24. 10 | 35. 45 |
| 3. 15  | 14. 4  | 25. 12 | 36. 14 |
| 4. 3   | 15. 8  | 26. 14 | 37. 16 |
| 5. 6   | 16. 12 | 27. 15 | 38. 18 |
| 6. 9   | 17. 6  | 28. 18 | 39. 21 |
| 7. 7   | 18. 12 | 29. 21 | 40. 24 |
| 8. 14  | 19. 8  | 30. 20 | 41. 27 |
| 9. 9   | 20. 16 | 31. 24 | 42. 28 |
| 10. 18 | 21. 25 | 32. 28 | 43. 32 |
| 11. 2  | 22. 30 | 33. 35 | 44. 36 |

**Problem Set**

- Answers will vary.
  - No, explanations will vary.
- A, C, D
  - Answers will vary.
  - Answers will vary.
- Circle shaded correctly
- Yes, explanations will vary.

**Exit Ticket**

- Yes; explanations will vary.
- Circle shaded

**Homework**

- Circles shaded correctly
- Answers will vary.
- No; explanations will vary.
- Marissa; explanations will vary.
  - Explanations will vary.
- Circle shaded

## Lesson 33

### Sprint

#### Side A

1. 2	12. 4	23. 2	34. 6
2. 3	13. 2	24. 5	35. 4
3. 5	14. 3	25. 4	36. 8
4. 10	15. 5	26. 7	37. 4
5. 2	16. 4	27. 2	38. 9
6. 3	17. 10	28. 5	39. 3
7. 5	18. 2	29. 4	40. 8
8. 4	19. 3	30. 7	41. 3
9. 2	20. 5	31. 8	42. 8
10. 3	21. 2	32. 6	43. 8
11. 5	22. 3	33. 9	44. 9

#### Side B

1. 2	12. 4	23. 2	34. 6
2. 3	13. 2	24. 5	35. 5
3. 5	14. 3	25. 3	36. 9
4. 10	15. 5	26. 7	37. 5
5. 2	16. 4	27. 2	38. 8
6. 3	17. 10	28. 5	39. 4
7. 5	18. 2	29. 3	40. 9
8. 4	19. 3	30. 7	41. 5
9. 2	20. 5	31. 9	42. 9
10. 3	21. 2	32. 6	43. 7
11. 5	22. 3	33. 8	44. 8

**Problem Set**

Answers will vary.

**Exit Ticket**

Answers will vary.

**Homework**

Answers will vary.

## Lesson 34

### Sprint

#### Side A

- |        |        |        |        |
|--------|--------|--------|--------|
| 1. 6   | 12. 5  | 23. 14 | 34. 9  |
| 2. 3   | 13. 12 | 24. 24 | 35. 42 |
| 3. 15  | 14. 3  | 25. 36 | 36. 49 |
| 4. 3   | 15. 28 | 26. 35 | 37. 7  |
| 5. 8   | 16. 2  | 27. 6  | 38. 7  |
| 6. 2   | 17. 6  | 28. 6  | 39. 36 |
| 7. 9   | 18. 2  | 29. 8  | 40. 64 |
| 8. 3   | 19. 24 | 30. 5  | 41. 9  |
| 9. 12  | 20. 4  | 31. 16 | 42. 7  |
| 10. 3  | 21. 2  | 32. 27 | 43. 9  |
| 11. 25 | 22. 24 | 33. 8  | 44. 8  |

#### Side B

- |       |        |        |        |
|-------|--------|--------|--------|
| 1. 10 | 12. 3  | 23. 14 | 34. 9  |
| 2. 5  | 13. 14 | 24. 24 | 35. 42 |
| 3. 6  | 14. 3  | 25. 36 | 36. 49 |
| 4. 2  | 15. 24 | 26. 35 | 37. 7  |
| 5. 6  | 16. 2  | 27. 6  | 38. 7  |
| 6. 3  | 17. 7  | 28. 6  | 39. 36 |
| 7. 16 | 18. 2  | 29. 8  | 40. 64 |
| 8. 4  | 19. 27 | 30. 5  | 41. 9  |
| 9. 12 | 20. 4  | 31. 16 | 42. 7  |
| 10. 4 | 21. 2  | 32. 27 | 43. 9  |
| 11. 9 | 22. 28 | 33. 8  | 44. 8  |

### Problem Set

Summer Math Review Calendar